

stylex

Metrum

PRICE LIST

Effective November 01, 2024

General Information

STYLEX PRICE LIST

GENERAL INFORMATION

Terms

Net 30 days from date of invoice,
F. O. B . Delanco, New Jersey.

Damaged Shipments

All Stylex products are carefully inspected before they are packed in sturdy cartons designed to satisfy shipping requirements. Stylex is not responsible for damage in shipment. The transportation company assumes responsibility for delivering products to you in good condition when the bill of lading is signed. You protect yourself by refusing shipments showing damage or shortage until transportation company has noted on the delivery sheet the extent of damage or shortage. Concealed damage should be reported to the carrier as soon as discovered, but no later than 5 days after receiving shipment.

Return/Restocking Policy

Return shipments will not be accepted unless specifically authorized by Stylex in writing. The Return Authorization number should be clearly marked on the carton. The customer returning Stylex products is responsible for return shipping costs. Merchandise must be returned unused. Returned merchandise is subject to a 35% restocking fee.

Special Products

Modifications to standard products will be considered for large runs. Contact factory for price quotations.

Design Changes

In keeping with modern manufacturing advances, Stylex reserves the right to incorporate minor modifications and design changes in products without notice.

Cancellation/Change Order Policy

Regarding requests for order cancellation and/or order modification, please be advised that no charges will be applied before production, unless inventory has been specifically requisitioned to fulfill your order. Once orders proceed to the production phase, they cannot be altered or canceled under any circumstances. All requests for order cancellations or order changes must be submitted in writing and will only be considered valid upon approval by Stylex.

WARRANTY

Except as provided below, Stylex warrants exclusively to the original Purchaser of our product that all parts, under normal use and service, will be free from defects in workmanship and material for a period of ten (10) years from the date of purchase. "Normal use and service" means that the product will be used in a typical office environment for 40-45 hours per week.

This warranty is subject to the following limitations, exclusions and provisions:

Limitations involving materials and components:

Wood components of plywood stacking chairs
(such as Brooks and Welcome)
5 years

Upholstery

(including mesh used for Click, F4, Insight, and Zephyr Mesh)
3 years

SAVA Mesh

10 years

Pneumatic Cylinders

3 years

COM Upholstery

No warranty
Stylex makes every effort to ensure that the COM Upholstery it approves is suitable for the intended use. Nevertheless, we will not warrant, and assume no responsibility for, the durability or tailoring quality of any COM or COL . If you have any concerns about the ultimate appearance of any covering, please order an upholstered sample.

Painted Stack Chair Frames

No Warranty
We will not warrant the finish of painted stack chair frames against damage from stacking. Please order chrome frames for chairs that will be stacked.

Felt Glides

No warranty
Due to the different surfaces on which felt glides may be used, we cannot warrant their durability over time.

If this product fails during normal use and service within the applicable warranty period (other than through normal wear and tear), please submit a warranty claim at stylexdesign.com/warranty-claim/. Quantity, model details, description of issue, and Stylex certified labels are required for submission. PLEASE DO NOT RETURN PARTS OR THE PRODUCT TO STYLEX UNLESS INSTRUCTED TO DO SO BY STYLEX. Stylex will, at its discretion, either repair or replace the defective product or part at no cost. Labor requests must receive approval and will be authorized on a case-by-case basis. We will only reimburse for labor costs directly incurred, excluding any travel-related expenses. Purchaser may be required (at the option of Stylex) to return to Stylex at Purchaser's expense any defective part with all freight or shipping charges prepaid. The foregoing warranty shall be void if the product has been altered or repaired (other than by Stylex). The warranty does not cover damage to the product caused by accident, neglect, misuse, abuse, modification to the product by anyone other than Stylex or damage caused by use of the product for a purpose other than that for which it was designed. This warranty extends only to the original Purchaser of the product.

No Other Warranties

This warranty is in lieu of all other warranties, expressed or implied, including, but not limited to, implied warranties of merchantability and fitness for a particular purpose. The rights and remedies provided herein are the exclusive rights and remedies of the original purchaser of the product.

No Liability For Damages

In no event shall Stylex or its suppliers be responsible or liable for any special, indirect, consequential, or incidental damages. In no event shall the liability of Stylex exceed the actual purchase price paid to Stylex for the product.

Out of Warranty Products

For all products no longer covered by our warranty, please refer to our Design for Durability and Upgradability Policy. Contact your Account Manager if you would like to purchase any replaceable components to further extend the life of any Stylex seating product. This warranty applies to all Stylex products purchased on April 13, 2018, and thereafter.

PRODUCT TAKE BACK PROGRAM

In order to be good stewards of our products, Stylex offers a pathway towards a Product Take Back Program as a more viable solution to the end of our products' originally intended life.

Stylex supports the sustainable programs of ANEW and offers their added value to our clients through a comprehensive take-back solution for surplus office furniture and materials of any kind, in any condition. ANEW is a 501(c)(3) non-profit organization that exists to provide companies with smart, cost effective alternatives for their surplus furniture and other items with the priority of matching it to non- profits, public agencies and the underserved, within the local community of the project site. Corporate Social Responsibility is raised while the impact on the environment is lowered by diverting products and materials otherwise destined for landfill.

Stylex is proud to offer ANEW to customers dedicated to strengthening their community network by repurposing their furniture, fixtures and architectural materials to those in need. In 2014, Stylex committed to making this relationship a part of our strategic sales strategy. Visit www.anewfound.org to find out more.

To initiate a Product Take Back strategy through ANEW, contact Stylex Account Management at 800-257-5742.

For other end of life recovery options, please see our Product Disassembly Instructions and End of Life Recovery Options documents available on our website in the resources section of each product in our line.

FREIGHT PROGRAM

Freight charges will be calculated as a percentage of the net product price and added to the invoice at the time of shipment. The continental United States has been divided into three zones. Please use the map below to determine freight charges for the product's destination. Minimum freight charge is \$250. Please let us know if you will be shipping to a residential address or require inside delivery as this requires an additional fee. Also please note we need to be made aware if a liftgate is required prior to delivery. If any requests are made at the time of delivery, applicable charges will apply.

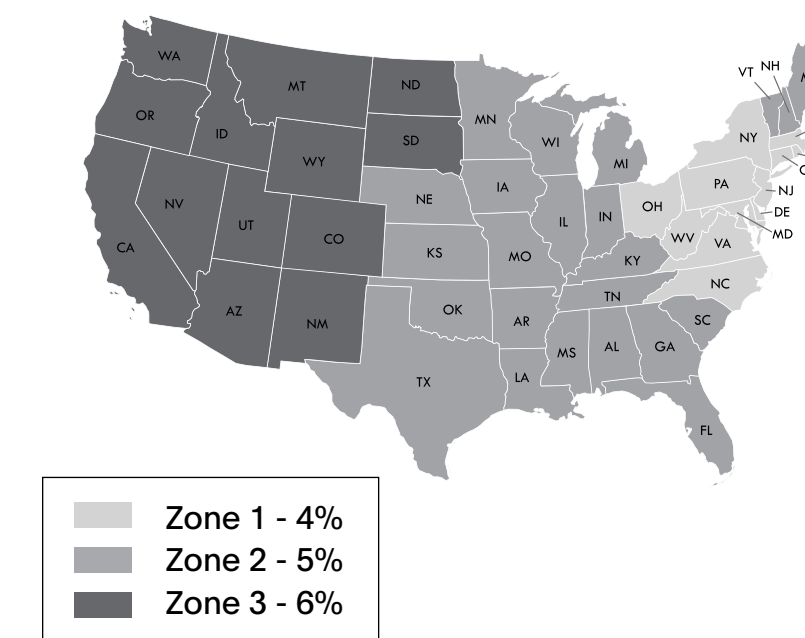

ZONE 1 - 4%

Connecticut
Delaware
New York
New Jersey
Maryland
Massachusetts
North Carolina
Ohio
Pennsylvania
Rhode Island
Virginia
Washington D.C.
West Virginia

ZONE 2 - 5%

Alabama
Arkansas
Canada, Ontario
Canada, Quebec
Florida
Georgia
Iowa
Illinois
Indiana
Kansas
Kentucky
Louisiana
Nebraska
New Hampshire
Oklahoma
Maine
Michigan
Minnesota
Missouri
Mississippi
South Carolina
Tennessee
Texas
Vermont
Wisconsin

ZONE 3 - 6%

Arizona
California
Colorado
Idaho
Montana
Nevada
New Mexico
North Dakota
Oregon
South Dakota
Utah
Washington
Wyoming

Quote Per Project
Alaska
Hawaii
Canada
(outside Ontario & Quebec)
Mexico

General Information

STYLEX PRICE LIST

TEXTILE PARTNERS & APPROVALS

Textile Partners

To customize your furniture performance needs and design vision, Stylex offers a wide selection of in-graded leathers and textiles from Grades A through Y. We've partnered with leading manufacturers on the options, focusing on color, price, durability, and construction. To view our partners and explore our digital carded program with broadly approved textiles, visit [this page](#). We stand by these textiles: They're tried and tested, and will effortlessly fit into any design aesthetic.

Textile Approvals

All textiles must be approved for the product you are specifying. For the related approved textile lists, visit [this page](#).

CAL 117 AND 133 COMPLIANCE

CAL 117-2013

CAL 117-2013 compliance is a requirement for all textiles applied on our seating products. All Stylex seating products meet this standard.

CAL 133

Most Stylex seating can be ordered to meet the requirements of CAL 133. When ordering, simply specify "CAL 133 compliance required". The upcharge for this option is \$54 list per yard. Please refer to the COM yardage of each model to determine the number of yards required. We do frequently require full-scale burn tests in order to certify CAL 133 before an order will be accepted. Such burn tests may increase normal lead times and do carry additional charges. Please contact your Stylex account manager for details.

CUSTOMER'S OWN MATERIAL/LEATHER

Customer's own material (COM) and customer's own leather (COL) will generally be upholstered at the price designated in each product's price list. Please be advised, however, that we specifically reserve the right to charge a higher price when we determine that special circumstances, such as unusual repeats or challenging materials, present themselves. All orders for custom coverings must be approved by Stylex before they will be accepted for production. To submit proposed textile for approval, please use the COM form [here](#).

Special Note:

We assume no responsibility for the durability or tailoring quality of any COM or COL. Directional covers in particular may not meet your satisfaction due to the design of certain products. Please be advised that COM and COL orders are not subject to return. If you have doubts about the ultimate appearance of certain coverings, please order a sample done with that specific COM or COL. In addition, while we inspect fabrics for mill imperfections, some are difficult to recognize. We cannot be responsible for defects, color inaccuracies, dye lot variations, or other flaws.

Under no circumstances will we be responsible for COM shortages, flaws, or other such problems. Finally, it is not our responsibility to police the receipt of COM's in order to meet delivery deadlines, and we assume our customers are aware of any undue delay in the shipment of their COM fabrics.

COM fabric and COL leather should be sent prepaid to: Stylex

**Attn: COM/COL - [Your Stylex PO #]
740 Coopertown Road
Delanco, NJ 08075**

All COM/COL sent to Stylex must be accompanied with a packing list which indicates the dealers' name, Stylex corresponding PO number, sales order number, COM/COL supplier name, textile pattern, colorway and shipped quantity. Stylex requires COM to be sent in as continuous yardage in the same dielot.

Yardage requirements shown in the price list are based on non-directional goods of 54" width. Fabrics less than 54" wide or those requiring matching (stripes, prints, or large patterned designs) call for additional yardage. We will be happy to supply yardage requirements for large quantities where economies may be realized.

Add the following yardage for stripes, plaids, or patterns with repeats:

Fabric Width	Plain Fabric	2-14" Repeat	15-24" Repeat	25-27" Repeat	28-36" Repeat
54"	0%	10%	15%	20%	25%
50"	10%	20%	25%	30%	35%
48"	15%	25%	30%	35%	40%
45"	40%	50%	55%	60%	65%
36"	50%	60%	65%	70%	75%

COM/COL FORM

To avoid delay in processing COM orders we request that you submit a sample of your COM textile stapled to this form which can be downloaded [here](#). If a textile has a stripe or design, the size of the repeat should be indicated. Please indicate the textile supplier's name, textile number, and color. Also indicate the Stylex product on which the textile will be used. If a certain direction of application is required, please ensure that information is communicated directly to your Stylex account manager.

The fabric supplier must indicate on his shipping labels the dealer name and purchase order number as well as the Stylex model number.

Please Note:

No order may be entered into production or have a shipping date assigned until all related COM is received at the factory.



CENTER OF STRIPE OR DESIGN

TOP OF CHAIR	TOP OF CHAIR
--------------	--------------

1. Size of Repeat

2. Textile Supplier

3. Textile Number

4. Color

5. Stylex Product

Metrum

Contents

<hr/>		<hr/>	
COLORS, MATERIALS, AND FINISHES	5	ARM CHAIRS	10
<hr/>		<hr/>	
STATEMENT OF LINE	6	ARMLESS CHAIRS	12
<hr/>		<hr/>	
OPTIONS & POWER	7	SETTEE & BENCH	14
<hr/>		<hr/>	
DIMENSIONS	8	MODULAR ARMS	15
<hr/>		<hr/>	
HOW TO ORDER	9	TABLE	17
<hr/>		<hr/>	

CLICK THE TITLES ABOVE TO NAVIGATE THROUGH THE DOCUMENT
PRODUCT HEADERS ON SUBSEQUENT PAGES LINK BACK TO THIS PAGE

Metrum

COLORS, MATERIALS, AND FINISHES

POWDER COATED PAINTED METAL

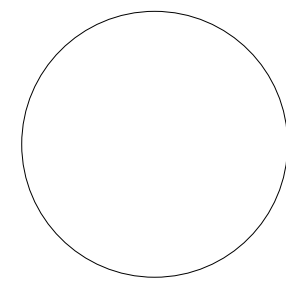

MILK
(MK)

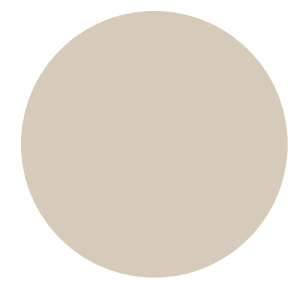

SAND
(SD)

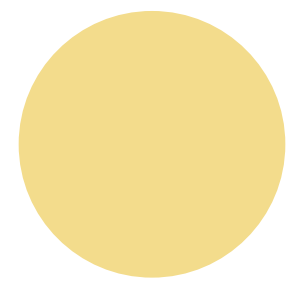

PALE YELLOW
(PY)

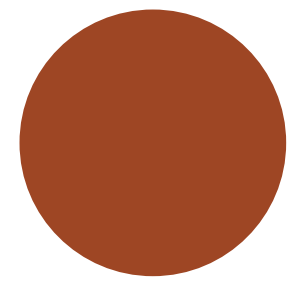

TERRACOTTA
(TC)

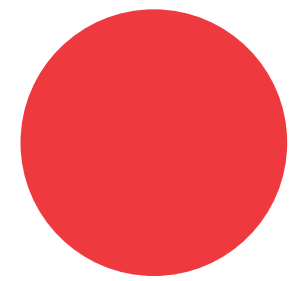

LIPSTICK RED
(LR)

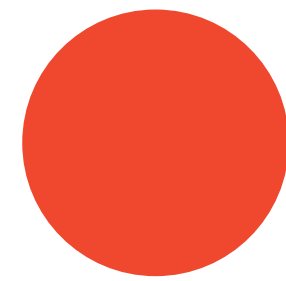

RED ORANGE
(RO)

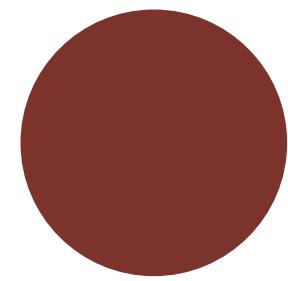

RUSTY RED
(RR)

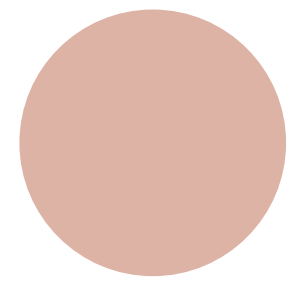

DUSTY PINK
(DP)

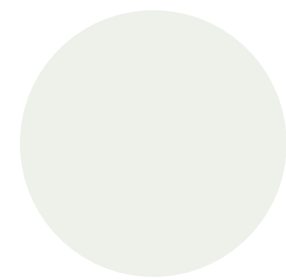

LIGHT PISTACHIO
(LP)

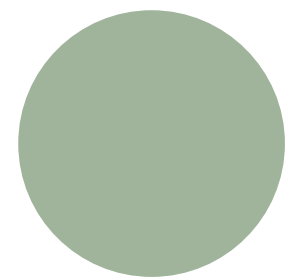

MEADOW GREEN
(MG)

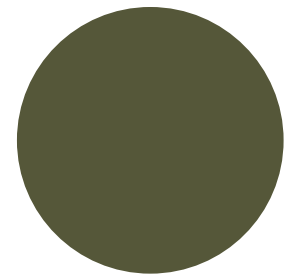

DARK SAGE
(DS)

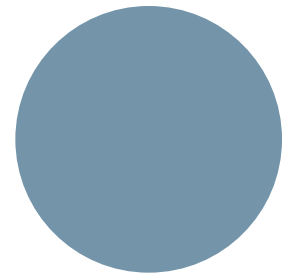

SOFT BLUE
(SB)

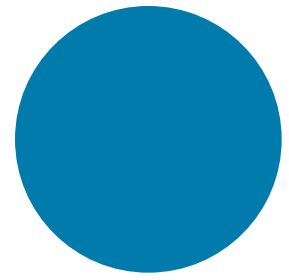

BLUE
(BL)

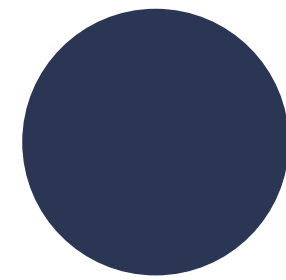

MIDNIGHT BLUE
(MB)



LILAC GRAY
(LL)

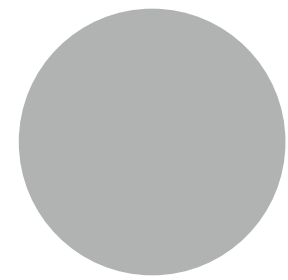

LIGHT GRAY
(LG)



CHAMPAGNE
(CP)

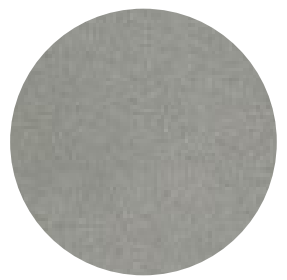

METALLIC SILVER
(MS)



NICKEL
(NK)

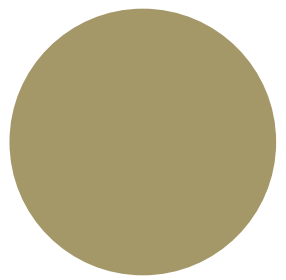

OCHRE
(OC)

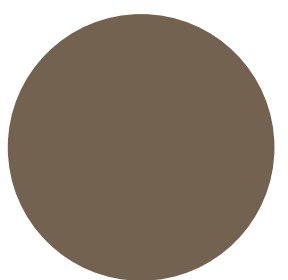

TAUPE
(TP)



DARK BRONZE
(DB)

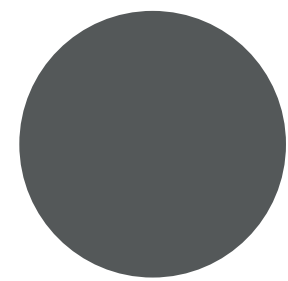

DARK GRAY
(DG)

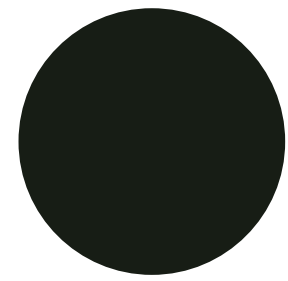

BLACK MATTE
(BM)

POLISHED METAL

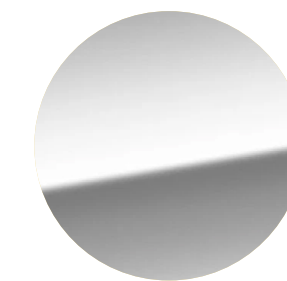

POLISHED
ALUMINUM
(AL)

WOOD LEG FINISH



NATURAL MAPLE
(83)







WHITE OAK
(81)

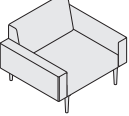
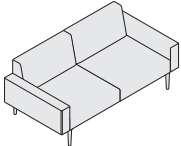
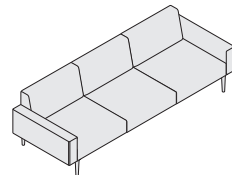
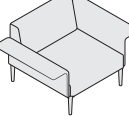
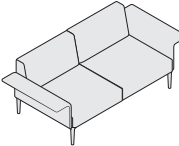
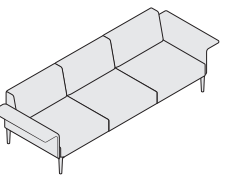

WALNUT
(85)

Metrum

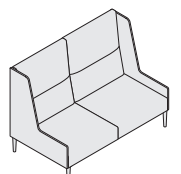
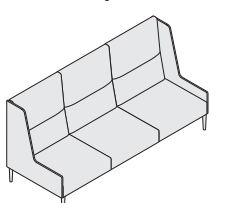
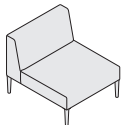
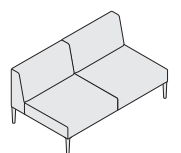
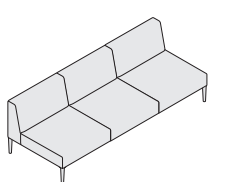
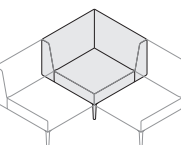
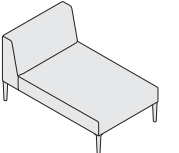
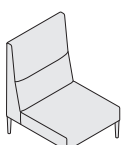
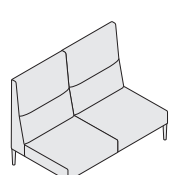
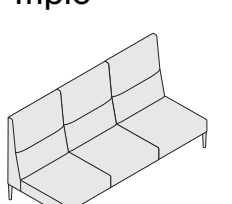
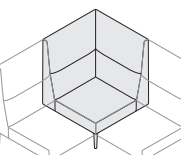
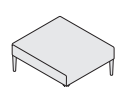
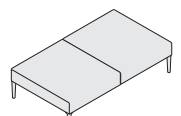
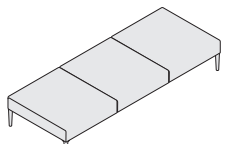
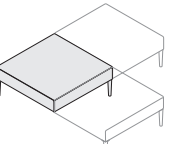
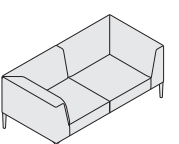
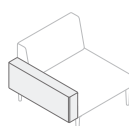
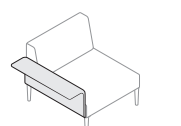
SPECIFICATION GUIDE: STATEMENT OF LINE

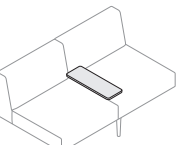
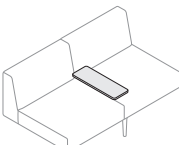
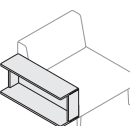
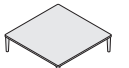
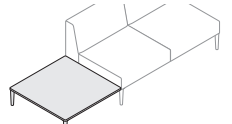
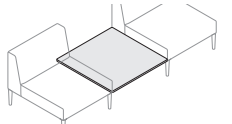
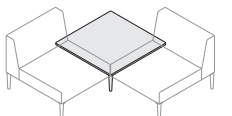
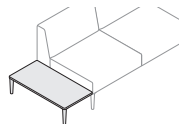
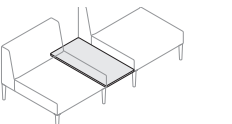
OVERVIEW						
Low Back Chairs with Arms	Single Standard Arm	Double Standard Arm	Triple Standard Arm	Single Canteliver Arm	Double Canteliver Arm	Triple Canteliver Arm
						
High Back Chairs with Arms	Single Privacy Arm	Double Privacy Arm	Triple Privacy Arm			
						
Low Back Chairs Armless	Single	Double	Triple	Corner	Chaise	
						
High Back Chairs Armless	Single	Double	Triple	Corner		
						
Benches & Settee	Single	Double	Triple	Corner	Settee	
						
Modular Arms	Standard Arm	Cantilever Arm	Privacy Arm	Mid Arm, Upholstered	Mid Arm, Wood	Bookshelf Arm
						
Tables	Stand Alone	Full End	Ful Mid	Full Corner	Half End	Half Mid
						

PRODUCT INFORMATION

Design

Stylex

Legs

Metrum is available with cast aluminum or wood legs. Cast aluminum legs may be powder coated in a variety of finishes, or ordered as polished cast aluminum. Wood legs are available in maple, white oak, and walnut. Adjustable glides are standard.

Arms

Metrum offers two categories of arms – end arms that can only be added to the outside ends of a unit, and mid-arms that can be added between units in a continuous layout.

Configuration

While Metrum offers traditional standalone units (single seat, double seat, and triple seat), it is at the same time fundamentally flexible. The modular armless seats, corners, arms, and tables have all been designed to encourage creation of a wide variety of setups. Units next to each other in a continuous layout share a mid-leg that supports both units. To ensure clarity when ordering modular set-ups, it is critical that line items should be listed in the order in which they will be connected from left end (seated perspective) to right end.

Testing

Manufactured to comply with ANSI/BIFMA X5.4 Public and Lounge Seating Standard

Environment

Greenguard Certified Level® 2

Metrum

SPECIFICATION GUIDE: OPTIONS & POWER

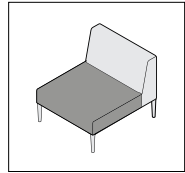
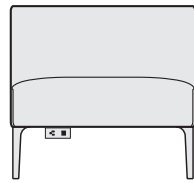
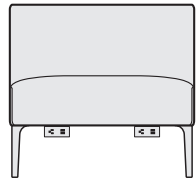
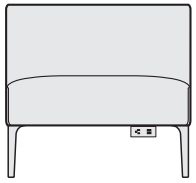
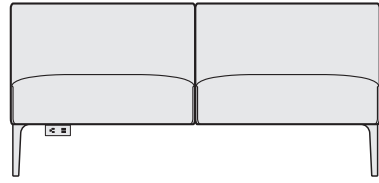
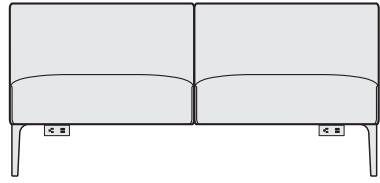
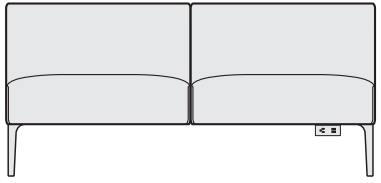
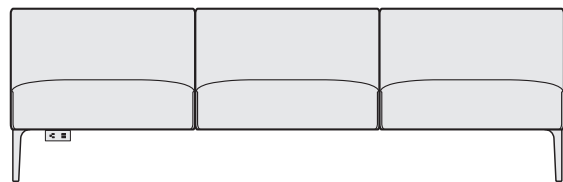
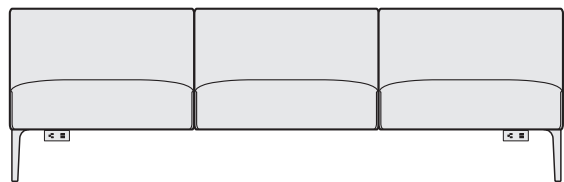
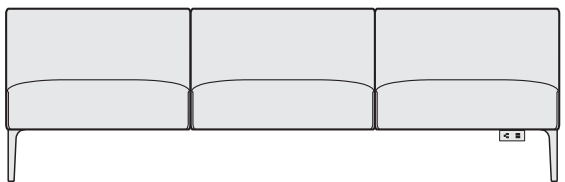
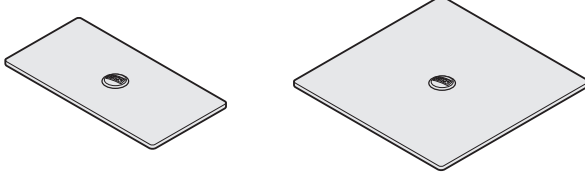
OPTIONS			
Upholstery Options	Welt Cord 	Dual Upholstery 	
POWER	RIGHT	RIGHT & LEFT	LEFT
Single Chair			
Double Chair			
Triple Chair			
Tables Half and Full Top			

To Order Power Select Below

1. Chair Power Module



U1 UNDER SEAT - 10FT CORD

2. Color

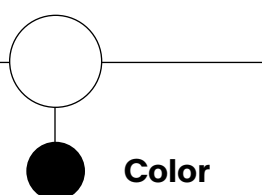

B BLACK
W WHITE
G GRAY

3. Location

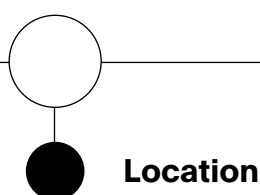

1 LEFT +540
2 RIGHT +540
3 LEFT & RIGHT +1,080

1. Table Power Module



S1 TABLE SURFACE - 10FT CORD +534

2. Color

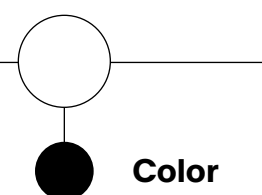

B BLACK
W WHITE
G GRAY

Wire Management Channel



WM SINGLE/TABLE +35
WM DOUBLE/CORNER/SETTEE +70
WM TRIPLE +105

PRODUCT INFORMATION

Capabilities & Mounting Options

Power units contain one USB-A port, one USB-C port, and a standard, grounded 3-prong electrical outlet. Available for surface mount in tables or undermounted on the front of seat units by either the left or right leg. Table surface mount power is designated by (S) in the model code. Power mounted under seat units is designated by (U) in the model code.

Cord Length

All power units are available with 10' cords.

Colors

Power units are available in black (B), white (W), and gray (G).

Location

Table surface mount power is centered on tables. Power mounted under seat units is located under the front edge next to the left leg (1), right leg (2), or both (3) from a seated perspective.

Examples:

S1B – Table surface, 10' cord, Black
U1W2 – Under Seat, 10' cord, White, Right Side.

Restrictions

Power is not available on corner seats or arms.

Metrum

SPECIFICATION GUIDE: DIMENSIONS

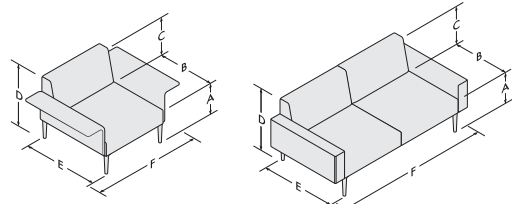
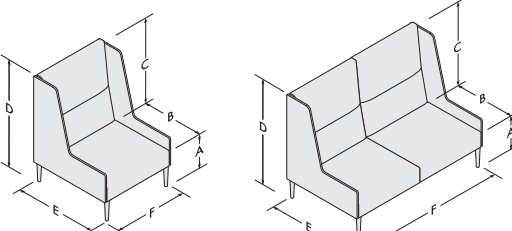
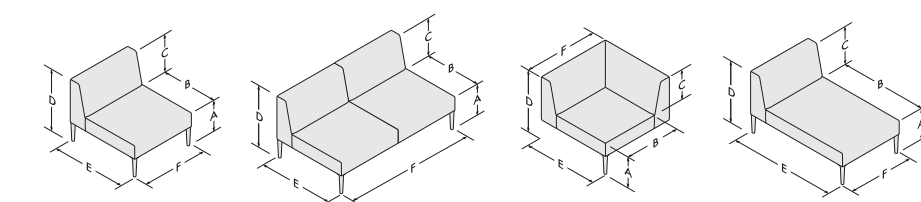
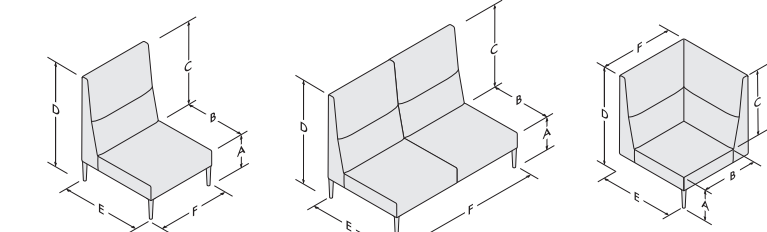
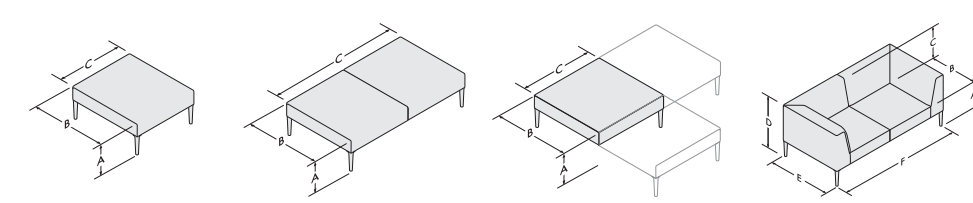
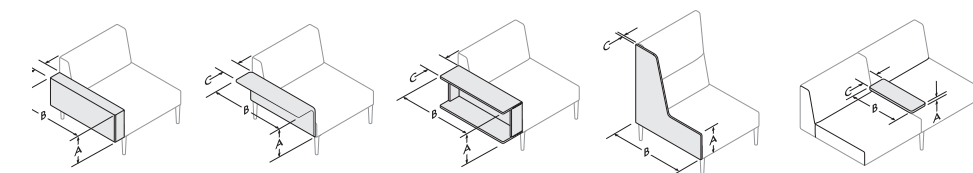
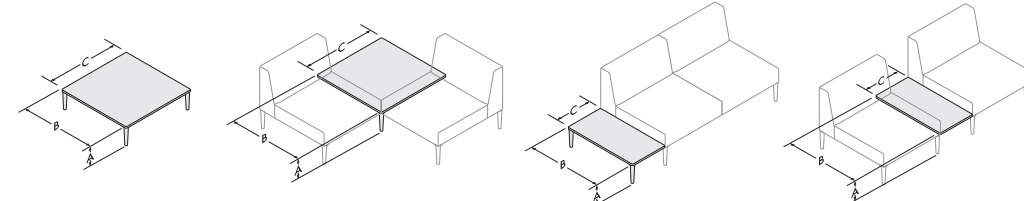
DIMENSIONS							
Low Back Chairs, with Arms A. Seat Height B. Seat Depth C. Back Height D. Overall Height E. Overall Depth F. Overall Length		Single, Standard Arm A. 16 B. 23.5 C. 12 D. 28 E. 33.75 F. 41.25	Double, Standard Arm A. 16 B. 23.5 C. 12 D. 28 E. 33.75 F. 71	Triple, Standard Arm A. 16 B. 23.5 C. 12 D. 28 E. 33.75 F. 100.75	Single, Canteliver Arm A. 16 B. 23.5 C. 12 D. 28 E. 33.75 F. 48	Double, Canteliver Arm A. 16 B. 23.5 C. 12 D. 28 E. 33.75 F. 77.75	Triple, Canteliver Arm A. 16 B. 23.5 C. 12 D. 28 E. 33.75 F. 107.5
High Back Chairs, with Arms A. Seat Height B. Seat Depth C. Back Height D. Overall Height E. Overall Depth F. Overall Length		Single, Privacy Arm A. 16 B. 23.5 C. 28.5 D. 44.5 E. 33.75 F. 33.75	Double, Privacy Arm A. 16 B. 23.5 C. 28.5 D. 44.5 E. 33.75 F. 63.75	Triple, Privacy Arm A. 16 B. 23.5 C. 28.5 D. 44.5 E. 33.75 F. 93.75			
Low Back Chairs, Armless A. Seat Height B. Seat Depth C. Back Height D. Overall Height E. Overall Depth F. Overall Length		Single A. 16 B. 23.5 C. 12 D. 28 E. 33.75 F. 29.75	Double A. 16 B. 23.5 C. 12 D. 28 E. 33.75 F. 59.5	Triple A. 16 B. 23.5 C. 12 D. 28 E. 33.75 F. 89.25	Corner A. 16 B. 23.5 C. 12 D. 28 E. 33.75 F. 33.75	Chaise A. 18 B. 38.5 C. 12 D. 28 E. 48.75 F. 29.75	
High Back Chairs, Armless A. Seat Height B. Seat Depth C. Back Height D. Overall Height E. Overall Depth F. Overall Length		Single A. 16 B. 23.5 C. 28.5 D. 44.5 E. 33.75 F. 29.75	Double A. 16 B. 23.5 C. 28.5 D. 44.5 E. 33.75 F. 59.5	Triple A. 16 B. 23.5 C. 28.5 D. 44.5 E. 33.75 F. 89.25	Corner A. 16 B. 23.5 C. 28.5 D. 44.5 E. 33.75 F. 33.75		
Benches & Settee A. Overall Height B. Overall Depth C. Overall Length		Single A. 16 B. 33.75 C. 29.75	Double A. 16 B. 33.75 C. 59.5	Triple A. 16 B. 33.75 C. 89.25	Corner A. 16 B. 33.75 C. 33.75	Settee A. Seat Height: 16 B. Seat Depth: 23.5 C. Back Height: 12 D. Overall Height: 28 E. Overall Depth: 33.75 F. Overall Length: 66.875	
Modular Arms A. Arm Height B. Arm Depth C. Arm Width		Standard Arm A. 13.5 B. 33.75 C. 5.75	Cantilever Arm A. 13.5 B. 33.25 C. 9.125	Privacy Arm A. 12 B. 33.5 C. 2	Mid Arm, Upholstered A. 4.25" above seat B. 22.5 C. 8	Mid Arm, Wood A. 3" above seat B. 22 C. 7.5	Bookshelf Arm A. 14 B. 33 C. 10
Tables A. Height B. Depth C. Width		Stand Alone A. 9.25-9.5 B. 33.5 C. 33.5	Full End A. 9.25-9.5 B. 33.5 C. 33.5	Full Mid A. 9.25-9.5 B. 33.5 C. 33.5	Full Corner A. 9.25-9.5 B. 33.5 C. 33.5	Half End A. 9.25-9.5 B. 33.5 C. 20	Half Mid A. 9.25-9.5 B. 33.5 C. 20

Metrum

SPECIFICATION GUIDE: HOW TO ORDER

MODEL CODE BREAKDOWN - SEATING

Sample Model Code: **MT11B44W5U1B1W81COM**

1. Series	2. Arm Option	3. Arm Finish	4. Welt Cord	5. Dual Upholstery	6. Power Options	7. Leg	8. Leg Finish	9. Textile
MT11	B44	-	W5	-	U1B1	W	81	COM
<p>Bench</p> <p>MT01 BENCH SINGLE MT02 BENCH DOUBLE MT03 BENCH TRIPLE MT04 BENCH CORNER</p> <p>Chair</p> <p>MT11 LOW BACK CHAIR SINGLE MT12 LOW BACK CHAIR DOUBLE MT13 LOW BACK CHAIR TRIPLE MT14 LOW BACK CHAIR CORNER MT15 LOW BACK CHAIR CHAISE MT21 HIGH BACK CHAIR SINGLE MT22 HIGH BACK CHAIR DOUBLE MT23 HIGH BACK CHAIR TRIPLE MT24 HIGH BACK CHAIR CORNER MT32 SETTEE</p>	<p>Arm Option</p> <p>B41 CANTILEVER ARM B43 PRIVACY ARM B44 STANDARD ARM</p>	<p>Standard Powder Coated Metal</p> <p>BL BLUE BM BLACK MATTE CP CHAMPAGNE DB DARK BRONZE DG DARK GRAY DP DUSTY PINK DS DARK SAGE LG LIGHT GRAY LL LILAC GRAY LP LIGHT PISTACHIO LR LIPSTICK RED MB MIDNIGHT BLUE MG MEADOW GREEN MK MILK MS METALLIC SILVER NK NICKEL OC OCHRE PY PALE YELLOW RO RED ORANGE RR RUSTY RED SB SOFT BLUE SD SAND TC TERRACOTTA TP TAUPE</p>	<p>Welt Cord</p> <p>W1 WELT CORD ON SEATS W3 WELT CORD ON SEATS & BACKS W5 WELT CORD ON SEATS, BACKS & ARM</p>	<p>Dual Upholstery</p> <p>DF SECOND TEXTILE ON SEAT</p>	<p>Type/Cord Length</p> <p>U1 CHAIR POWER UNDER SEAT 10' POWER CORD</p> <p>Power Color</p> <p>B BLACK W WHITE G GRAY</p> <p>Power Position</p> <p>1 LEFT 2 RIGHT 3 LEFT & RIGHT</p> <p>Wire Management</p> <p>WM WIRE MANAGEMENT CHANNEL</p>	<p>Leg</p> <p>A CAST ALUMINUM LEG WITH ADJUSTABLE GLIDES W WOOD LEG WITH ADJUSTABLE GLIDES</p>	<p>Standard Powder Coated Metal</p> <p>BL BLUE BM BLACK MATTE CP CHAMPAGNE DB DARK BRONZE DG DARK GRAY DP DUSTY PINK DS DARK SAGE LG LIGHT GRAY LL LILAC GRAY LP LIGHT PISTACHIO LR LIPSTICK RED MB MIDNIGHT BLUE MG MEADOW GREEN MK MILK MS METALLIC SILVER NK NICKEL OC OCHRE PY PALE YELLOW RO RED ORANGE RR RUSTY RED SB SOFT BLUE SD SAND TC TERRACOTTA TP TAUPE</p> <p>Polished Metal</p> <p>AL POLISHED ALUMINUM</p> <p>Wood</p> <p>81 LIGHT OAK 83 NATURAL MAPLE 85 WALNUT</p>	<p>Textile Grades</p> <p>COM CUSTOMER'S OWN MATERIAL A GRADE A B GRADE B C GRADE C D GRADE D E GRADE E F GRADE F G GRADE G H GRADE H I GRADE I J GRADE J K GRADE K L GRADE L M GRADE M</p>

Metrum

LOW BACK CHAIR, STANDARD AND CANTILEVER ARM

Textile Upholstery Grades

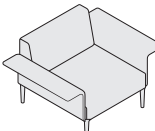
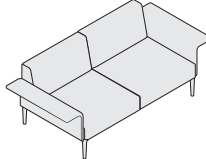
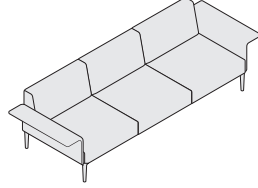
TITLE	SERIES	MODEL	ARM	DIMENSIONS	YDG	COM	A	B	C	D	E	F	G	H	I	J	K	L	M	
Low Back, Single, Arm 	Standard Arm	MT	11	B44	41.25W x 33.75D x 28H	5.5	3,138	3,567	3,796	4,027	4,257	4,495	4,754	5,003	5,304	5,701	6,166	6,635	7,095	7,560
	Cantilever Arm	MT	11	B41	48W x 33.75D x 28H	4	3,465	3,760	3,915	4,074	4,232	4,392	4,570	4,741	4,947	5,218	5,537	5,856	6,173	6,492
Low Back, Double, Arm 	Standard Arm	MT	12	B44	71W x 33.75D x 28H	7.6	4,838	5,426	5,742	6,055	6,371	6,696	7,050	7,391	7,805	8,347	8,985	9,624	10,252	10,890
	Cantilever Arm	MT	12	B41	77.75W x 33.75D x 28H	5.9	5,166	5,618	5,860	6,101	6,346	6,593	6,866	7,131	7,447	7,862	8,355	8,846	9,330	9,823
Low Back, Triple, Arm 	Standard Arm	MT	13	B44	100.75W x 33.75D x 28H	9.6	6,349	7,091	7,485	7,880	8,275	8,684	9,128	9,560	10,078	10,759	11,559	12,362	13,152	13,954
	Cantilever Arm	MT	13	B41	107.5W x 33.75D x 28H	7.9	6,677	7,280	7,603	7,926	8,249	8,580	8,945	9,297	9,720	10,274	10,928	11,585	12,230	12,886

To Order Select Below

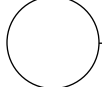
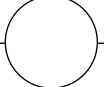
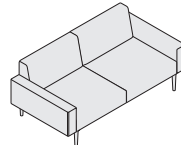
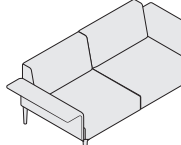
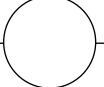
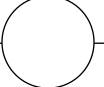
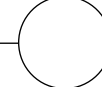
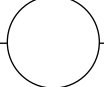
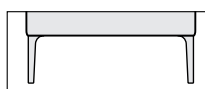
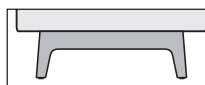
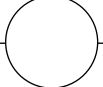
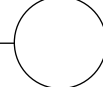
<p>1. Series/Model</p>  <p>Metrum Low Back</p> <table border="1"> <tr><td>MT11</td><td>SINGLE</td></tr> <tr><td>MT12</td><td>DOUBLE</td></tr> <tr><td>MT13</td><td>TRIPLE</td></tr> </table>	MT11	SINGLE	MT12	DOUBLE	MT13	TRIPLE	<p>2. Arm</p>  <p>Arm</p> <table border="1"> <tr><td>B44</td><td>STANDARD ARM</td></tr> <tr><td>B41</td><td>CANTILEVER ARM</td></tr> </table>  <p>B44</p>  <p>B41</p>	B44	STANDARD ARM	B41	CANTILEVER ARM	<p>3. Arm Finish</p>  <p>Arm Finish</p> <p>To choose Cantilever Arm finish, refer to Standard Powder Coated Metal Finishes listed in Leg Step 7.</p>	<p>4. Welt Cord</p>  <p>Welt Cord</p> <table border="1"> <tr><td>W3</td><td>WELT CORD ON SEATS & BACKS</td></tr> <tr><td>W5</td><td>WELT CORD ON SEATS, BACKS & ARMS</td></tr> </table> <p>Requires an additional 0.25 yds of fabric. Not available on cantilever arm. Not available on quilted fabric. Upcharges listed below:</p> <table border="1"> <tr><td>W3</td><td>Low Back, Single Seat</td><td>+82</td></tr> <tr><td>W5</td><td>Low Back, Single Seat</td><td>+208</td></tr> <tr><td>W3</td><td>Low Back, Double Seat</td><td>+164</td></tr> <tr><td>W5</td><td>Low Back, Double Seat</td><td>+289</td></tr> <tr><td>W3</td><td>Low Back, Triple Seat</td><td>+245</td></tr> <tr><td>W5</td><td>Low Back, Triple Seat</td><td>+371</td></tr> </table>	W3	WELT CORD ON SEATS & BACKS	W5	WELT CORD ON SEATS, BACKS & ARMS	W3	Low Back, Single Seat	+82	W5	Low Back, Single Seat	+208	W3	Low Back, Double Seat	+164	W5	Low Back, Double Seat	+289	W3	Low Back, Triple Seat	+245	W5	Low Back, Triple Seat	+371	<p>5. Power</p>  <p>Power</p> <p>Refer to power ordering steps on page 7.</p>	<p>6. Leg</p>  <p>Leg</p> <table border="1"> <tr><td>A</td><td>CAST ALUMINUM LEG WITH ADJUSTABLE GLIDE</td></tr> <tr><td>W</td><td>WOOD LEG WITH ADJUSTABLE GLIDE</td></tr> </table>  <p>A</p>  <p>W</p>	A	CAST ALUMINUM LEG WITH ADJUSTABLE GLIDE	W	WOOD LEG WITH ADJUSTABLE GLIDE	<p>7. Leg Finish</p>  <p>Standard Powder Coated Metal</p> <table border="1"> <tr><td>BL</td><td>BLUE</td></tr> <tr><td>BM</td><td>BLACK MATTE</td></tr> <tr><td>CP</td><td>CHAMPAGNE</td></tr> <tr><td>DB</td><td>DARK BRONZE</td></tr> <tr><td>DG</td><td>DARK GRAY</td></tr> <tr><td>DP</td><td>DUSTY PINK</td></tr> <tr><td>DS</td><td>DARK SAGE</td></tr> <tr><td>LG</td><td>LIGHT GRAY</td></tr> <tr><td>LL</td><td>LILAC GRAY</td></tr> <tr><td>LP</td><td>LIGHT PISTACHIO</td></tr> <tr><td>LR</td><td>LIPSTICK RED</td></tr> <tr><td>MB</td><td>MIDNIGHT BLUE</td></tr> <tr><td>MG</td><td>MEADOW GREEN</td></tr> <tr><td>MK</td><td>MILK</td></tr> <tr><td>MS</td><td>METALLIC SILVER</td></tr> <tr><td>NK</td><td>NICKEL</td></tr> <tr><td>OC</td><td>OCHRE</td></tr> <tr><td>PY</td><td>PALE YELLOW</td></tr> <tr><td>RO</td><td>RED ORANGE</td></tr> <tr><td>RR</td><td>RUSTY RED</td></tr> <tr><td>SB</td><td>SOFT BLUE</td></tr> <tr><td>SD</td><td>SAND</td></tr> <tr><td>TC</td><td>TERRACOTTA</td></tr> <tr><td>TP</td><td>TAUPE</td></tr> </table>	BL	BLUE	BM	BLACK MATTE	CP	CHAMPAGNE	DB	DARK BRONZE	DG	DARK GRAY	DP	DUSTY PINK	DS	DARK SAGE	LG	LIGHT GRAY	LL	LILAC GRAY	LP	LIGHT PISTACHIO	LR	LIPSTICK RED	MB	MIDNIGHT BLUE	MG	MEADOW GREEN	MK	MILK	MS	METALLIC SILVER	NK	NICKEL	OC	OCHRE	PY	PALE YELLOW	RO	RED ORANGE	RR	RUSTY RED	SB	SOFT BLUE	SD	SAND	TC	TERRACOTTA	TP	TAUPE	<p>8. Upholstery</p>  <p>Upholstery</p> <p>See general information section for details on textile program and COM/ COL information.</p> <table border="1"> <tr><td>AL</td><td>POLISHED ALUMINUM</td></tr> <tr><td>81</td><td>WHITE OAK</td><td>+806</td></tr> <tr><td>83</td><td>NATURAL MAPLE</td><td>+694</td></tr> <tr><td>85</td><td>WALNUT</td><td>+908</td></tr> </table> <p>Yardages provided are for non-directional fabrics that are applied railroaded. Directional fabrics may require additional yardage. Thick quilted fabrics will be need to be verified and may be handled as a custom order.</p>	AL	POLISHED ALUMINUM	81	WHITE OAK	+806	83	NATURAL MAPLE	+694	85	WALNUT	+908
MT11	SINGLE																																																																																																					
MT12	DOUBLE																																																																																																					
MT13	TRIPLE																																																																																																					
B44	STANDARD ARM																																																																																																					
B41	CANTILEVER ARM																																																																																																					
W3	WELT CORD ON SEATS & BACKS																																																																																																					
W5	WELT CORD ON SEATS, BACKS & ARMS																																																																																																					
W3	Low Back, Single Seat	+82																																																																																																				
W5	Low Back, Single Seat	+208																																																																																																				
W3	Low Back, Double Seat	+164																																																																																																				
W5	Low Back, Double Seat	+289																																																																																																				
W3	Low Back, Triple Seat	+245																																																																																																				
W5	Low Back, Triple Seat	+371																																																																																																				
A	CAST ALUMINUM LEG WITH ADJUSTABLE GLIDE																																																																																																					
W	WOOD LEG WITH ADJUSTABLE GLIDE																																																																																																					
BL	BLUE																																																																																																					
BM	BLACK MATTE																																																																																																					
CP	CHAMPAGNE																																																																																																					
DB	DARK BRONZE																																																																																																					
DG	DARK GRAY																																																																																																					
DP	DUSTY PINK																																																																																																					
DS	DARK SAGE																																																																																																					
LG	LIGHT GRAY																																																																																																					
LL	LILAC GRAY																																																																																																					
LP	LIGHT PISTACHIO																																																																																																					
LR	LIPSTICK RED																																																																																																					
MB	MIDNIGHT BLUE																																																																																																					
MG	MEADOW GREEN																																																																																																					
MK	MILK																																																																																																					
MS	METALLIC SILVER																																																																																																					
NK	NICKEL																																																																																																					
OC	OCHRE																																																																																																					
PY	PALE YELLOW																																																																																																					
RO	RED ORANGE																																																																																																					
RR	RUSTY RED																																																																																																					
SB	SOFT BLUE																																																																																																					
SD	SAND																																																																																																					
TC	TERRACOTTA																																																																																																					
TP	TAUPE																																																																																																					
AL	POLISHED ALUMINUM																																																																																																					
81	WHITE OAK	+806																																																																																																				
83	NATURAL MAPLE	+694																																																																																																				
85	WALNUT	+908																																																																																																				

Metrum

HIGH BACK CHAIR, PRIVACY ARM

Textile Upholstery Grades

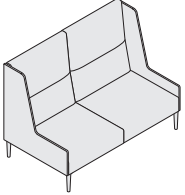
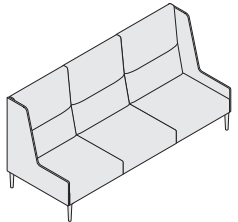
TITLE		SERIES	MODEL	ARM	DIMENSIONS	YDG	COM	A	B	C	D	E	F	G	H	I	J	K	L	M
High Back, Single, Arm		MT	21	B43	33.75W x 33.75D x 44.5H	6.6	3,528	4,034	4,302	4,574	4,843	5,123	5,429	5,721	6,076	6,552	7,090	7,638	8,178	8,727
High Back, Double, Arm		MT	22	B43	63.5W x 33.75D x 44.5H	9.5	5,543	6,268	6,654	7,044	7,429	7,827	8,265	8,687	9,194	9,859	10,644	11,432	12,208	12,992
High Back, Triple, Arm		MT	23	B43	93.25W x 33.75D x 44.5H	12.3	7,432	8,369	8,868	9,369	9,869	10,383	10,948	11,494	12,148	13,009	14,023	15,040	16,040	17,054

To Order Select Below

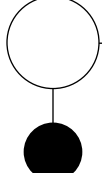
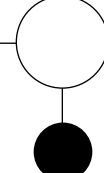
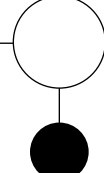
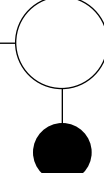
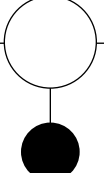
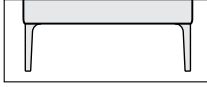
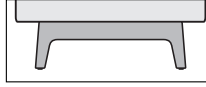
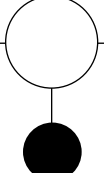
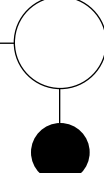
<p>1. Series/Model</p>  <p>Metrum High Back</p> <table border="1"> <tr><td>MT21</td><td>SINGLE</td></tr> <tr><td>MT22</td><td>DOUBLE</td></tr> <tr><td>MT23</td><td>TRIPLE</td></tr> </table>	MT21	SINGLE	MT22	DOUBLE	MT23	TRIPLE	<p>2. Arm</p>  <p>Arm</p> <table border="1"> <tr><td>B43</td><td>PRIVACY ARM</td></tr> </table>	B43	PRIVACY ARM	<p>3. Welt Cord</p>  <p>Welt Cord</p> <table border="1"> <tr><td>W3</td><td>WELT CORD ON SEATS & BACKS</td></tr> </table> <p>Requires an additional 0.25 yds of fabric. Not available on quilted fabric. Upcharges listed below:</p> <table border="1"> <tr><td>W3</td><td>High Back, Single Seat</td><td>+88</td></tr> <tr><td>W3</td><td>High Back, Double Seat</td><td>+177</td></tr> <tr><td>W3</td><td>High Back, Triple Seat</td><td>+265</td></tr> </table>	W3	WELT CORD ON SEATS & BACKS	W3	High Back, Single Seat	+88	W3	High Back, Double Seat	+177	W3	High Back, Triple Seat	+265	<p>4. Power</p>  <p>Power</p> <p>Refer to power ordering steps on page 7.</p>	<p>5. Leg</p>  <p>Leg</p> <table border="1"> <tr><td>A</td><td>CAST ALUMINUM LEG WITH ADJUSTABLE GLIDE</td></tr> <tr><td>W</td><td>WOOD LEG WITH ADJUSTABLE GLIDE</td></tr> </table> <div style="display: flex; justify-content: space-around; margin-top: 10px;">   </div>	A	CAST ALUMINUM LEG WITH ADJUSTABLE GLIDE	W	WOOD LEG WITH ADJUSTABLE GLIDE	<p>6. Leg Finish</p>  <table border="1"> <tr><td>BL</td><td>BLUE</td></tr> <tr><td>BM</td><td>BLACK MATTE</td></tr> <tr><td>CP</td><td>CHAMPAGNE</td></tr> <tr><td>DB</td><td>DARK BRONZE</td></tr> <tr><td>DG</td><td>DARK GRAY</td></tr> <tr><td>DP</td><td>DUSTY PINK</td></tr> <tr><td>DS</td><td>DARK SAGE</td></tr> <tr><td>LG</td><td>LIGHT GRAY</td></tr> <tr><td>LL</td><td>LILAC GRAY</td></tr> <tr><td>LP</td><td>LIGHT PISTACHIO</td></tr> <tr><td>LR</td><td>LIPSTICK RED</td></tr> <tr><td>MB</td><td>MIDNIGHT BLUE</td></tr> <tr><td>MG</td><td>MEADOW GREEN</td></tr> <tr><td>MK</td><td>MILK</td></tr> <tr><td>MS</td><td>METALLIC SILVER</td></tr> <tr><td>NK</td><td>NICKEL</td></tr> <tr><td>OC</td><td>OCHRE</td></tr> <tr><td>PY</td><td>PALE YELLOW</td></tr> <tr><td>RO</td><td>RED ORANGE</td></tr> <tr><td>RR</td><td>RUSTY RED</td></tr> <tr><td>SB</td><td>SOFT BLUE</td></tr> <tr><td>SD</td><td>SAND</td></tr> <tr><td>TC</td><td>TERRACOTTA</td></tr> <tr><td>TP</td><td>TAUPE</td></tr> </table>	BL	BLUE	BM	BLACK MATTE	CP	CHAMPAGNE	DB	DARK BRONZE	DG	DARK GRAY	DP	DUSTY PINK	DS	DARK SAGE	LG	LIGHT GRAY	LL	LILAC GRAY	LP	LIGHT PISTACHIO	LR	LIPSTICK RED	MB	MIDNIGHT BLUE	MG	MEADOW GREEN	MK	MILK	MS	METALLIC SILVER	NK	NICKEL	OC	OCHRE	PY	PALE YELLOW	RO	RED ORANGE	RR	RUSTY RED	SB	SOFT BLUE	SD	SAND	TC	TERRACOTTA	TP	TAUPE	<p>7. Upholstery</p>  <p>Upholstery</p> <p>See general information section for details on textile program and COM/ COL information.</p> <p>Yardages provided are for non-directional fabrics that are applied railroaded. Directional fabrics may require additional yardage. Thick quilted fabrics will be need to be verified and may be handled as a custom order.</p> <table border="1"> <tr><td>AL</td><td>POLISHED ALUMINUM</td></tr> <tr><td colspan="2">Wood</td></tr> <tr><td>81</td><td>WHITE OAK</td><td>+806</td></tr> <tr><td>83</td><td>NATURAL MAPLE</td><td>+694</td></tr> <tr><td>85</td><td>WALNUT</td><td>+908</td></tr> </table>	AL	POLISHED ALUMINUM	Wood		81	WHITE OAK	+806	83	NATURAL MAPLE	+694	85	WALNUT	+908
MT21	SINGLE																																																																																									
MT22	DOUBLE																																																																																									
MT23	TRIPLE																																																																																									
B43	PRIVACY ARM																																																																																									
W3	WELT CORD ON SEATS & BACKS																																																																																									
W3	High Back, Single Seat	+88																																																																																								
W3	High Back, Double Seat	+177																																																																																								
W3	High Back, Triple Seat	+265																																																																																								
A	CAST ALUMINUM LEG WITH ADJUSTABLE GLIDE																																																																																									
W	WOOD LEG WITH ADJUSTABLE GLIDE																																																																																									
BL	BLUE																																																																																									
BM	BLACK MATTE																																																																																									
CP	CHAMPAGNE																																																																																									
DB	DARK BRONZE																																																																																									
DG	DARK GRAY																																																																																									
DP	DUSTY PINK																																																																																									
DS	DARK SAGE																																																																																									
LG	LIGHT GRAY																																																																																									
LL	LILAC GRAY																																																																																									
LP	LIGHT PISTACHIO																																																																																									
LR	LIPSTICK RED																																																																																									
MB	MIDNIGHT BLUE																																																																																									
MG	MEADOW GREEN																																																																																									
MK	MILK																																																																																									
MS	METALLIC SILVER																																																																																									
NK	NICKEL																																																																																									
OC	OCHRE																																																																																									
PY	PALE YELLOW																																																																																									
RO	RED ORANGE																																																																																									
RR	RUSTY RED																																																																																									
SB	SOFT BLUE																																																																																									
SD	SAND																																																																																									
TC	TERRACOTTA																																																																																									
TP	TAUPE																																																																																									
AL	POLISHED ALUMINUM																																																																																									
Wood																																																																																										
81	WHITE OAK	+806																																																																																								
83	NATURAL MAPLE	+694																																																																																								
85	WALNUT	+908																																																																																								

Metrum

LOW BACK LOUNGE, ARMLESS

Textile Upholstery Grades

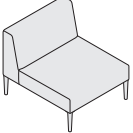
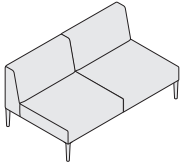
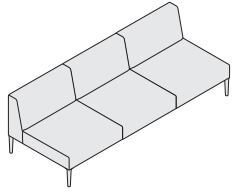
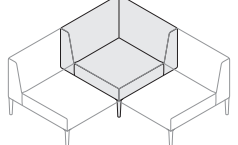
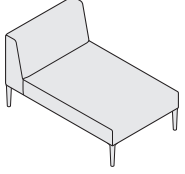
TITLE	SERIES	MODEL	DIMENSIONS	YDG	COM	A	B	C	D	E	F	G	H	I	J	K	L	M
Low Back, Single 	MT	11	29.75W x 33.75D x 28H	2.7	2,205	2,408	2,517	2,627	2,734	2,846	2,970	3,089	3,231	3,418	3,640	3,862	4,079	4,299
Low Back, Double 	MT	12	59.5W x 33.75D x 28H	4.8	3,905	4,268	4,462	4,655	4,848	5,047	5,266	5,477	5,731	6,064	6,458	6,850	7,236	7,630
Low Back, Triple 	MT	13	89.25W x 33.75D x 28H	6.8	5,416	5,931	6,206	6,479	6,754	7,036	7,344	7,644	8,005	8,476	9,032	9,589	10,137	10,694
Low Back, Corner 	MT	14	33.75W x 33.75D x 28H	3.6	3,149	3,422	3,566	3,711	3,857	4,005	4,169	4,328	4,519	4,768	5,064	5,358	5,649	5,944
Low Back, Chaise 	MT	15	29.75W x 33.75D x 28H	3.3	2,582	2,832	2,966	3,098	3,231	3,368	3,518	3,663	3,839	4,066	4,338	4,607	4,872	5,144

To Order Select Below

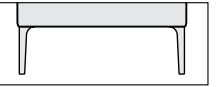
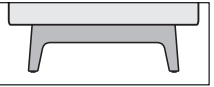
<p>1. Series/Model</p> <p>Metrum Low Back</p> <table border="1"> <tr><td>MT11</td><td>SINGLE</td></tr> <tr><td>MT12</td><td>DOUBLE</td></tr> <tr><td>MT13</td><td>TRIPLE</td></tr> <tr><td>MT14</td><td>CORNER</td></tr> <tr><td>MT15</td><td>CHAISE</td></tr> </table>	MT11	SINGLE	MT12	DOUBLE	MT13	TRIPLE	MT14	CORNER	MT15	CHAISE	<p>2. Welt Cord</p> <p>W3 WELT CORD ON SEATS & BACKS</p> <p>Requires an additional 0.25 yds of fabric. Not available on quilted fabric. Upcharges listed below:</p> <table border="1"> <tr><td>W3 Low Back, Single Seat</td><td>+82</td></tr> <tr><td>W3 Low Back, Double Seat</td><td>+164</td></tr> <tr><td>W3 Low Back, Triple Seat</td><td>+245</td></tr> <tr><td>W3 Low Back, Corner</td><td>+121</td></tr> <tr><td>W3 Low Back, Chaise</td><td>+121</td></tr> </table>	W3 Low Back, Single Seat	+82	W3 Low Back, Double Seat	+164	W3 Low Back, Triple Seat	+245	W3 Low Back, Corner	+121	W3 Low Back, Chaise	+121	<p>3. Dual Upholstery</p> <p>DF SECOND TEXTILE ON SEAT</p> <p>When specifying In-Graded textiles, please apply the higher of the two grades.</p> <table border="1"> <tr> <td>Low Back, Single Seat: 1.6 yds Back: 1.5 yds</td> <td>Low Back, Corner Seat: 1.6 yds Back: 2.4 yds</td> </tr> <tr> <td>Low Back, Double Seat: 2.6 yds Back: 2.2 yds</td> <td>Low Back, Chaise Seat: 2.4 yds Back: 1.5 yds</td> </tr> <tr> <td colspan="2">Low Back, Triple Seat: 3.6 yds Back: 3.3 yds</td> </tr> </table>	Low Back, Single Seat: 1.6 yds Back: 1.5 yds	Low Back, Corner Seat: 1.6 yds Back: 2.4 yds	Low Back, Double Seat: 2.6 yds Back: 2.2 yds	Low Back, Chaise Seat: 2.4 yds Back: 1.5 yds	Low Back, Triple Seat: 3.6 yds Back: 3.3 yds		<p>4. Power</p> <p>Refer to power ordering steps on page 7.</p>	<p>5. Leg</p> <table border="1"> <tr><td>A</td><td>CAST ALUMINUM LEG WITH ADJUSTABLE GLIDE</td></tr> <tr><td>W</td><td>WOOD LEG WITH ADJUSTABLE GLIDE</td></tr> </table> <div style="display: flex; justify-content: space-around; align-items: center;">  A  W </div>	A	CAST ALUMINUM LEG WITH ADJUSTABLE GLIDE	W	WOOD LEG WITH ADJUSTABLE GLIDE	<p>6. Leg Finish</p> <table border="1"> <tr><td>BL</td><td>BLUE</td></tr> <tr><td>BM</td><td>BLACK MATTE</td></tr> <tr><td>CP</td><td>CHAMPAGNE</td></tr> <tr><td>DB</td><td>DARK BRONZE</td></tr> <tr><td>DG</td><td>DARK GRAY</td></tr> <tr><td>DP</td><td>DUSTY PINK</td></tr> <tr><td>DS</td><td>DARK SAGE</td></tr> <tr><td>LG</td><td>LIGHT GRAY</td></tr> <tr><td>LL</td><td>LILAC GRAY</td></tr> <tr><td>LP</td><td>LIGHT PISTACHIO</td></tr> <tr><td>LR</td><td>LIPSTICK RED</td></tr> <tr><td>MB</td><td>MIDNIGHT BLUE</td></tr> <tr><td>MG</td><td>MEADOW GREEN</td></tr> <tr><td>MK</td><td>MILK</td></tr> <tr><td>MS</td><td>METALLIC SILVER</td></tr> <tr><td>NK</td><td>NICKEL</td></tr> <tr><td>OC</td><td>OCHRE</td></tr> <tr><td>PY</td><td>PALE YELLOW</td></tr> <tr><td>RO</td><td>RED ORANGE</td></tr> <tr><td>RR</td><td>RUSTY RED</td></tr> <tr><td>SB</td><td>SOFT BLUE</td></tr> <tr><td>SD</td><td>SAND</td></tr> <tr><td>TC</td><td>TERRACOTTA</td></tr> <tr><td>TP</td><td>TAUPE</td></tr> </table>	BL	BLUE	BM	BLACK MATTE	CP	CHAMPAGNE	DB	DARK BRONZE	DG	DARK GRAY	DP	DUSTY PINK	DS	DARK SAGE	LG	LIGHT GRAY	LL	LILAC GRAY	LP	LIGHT PISTACHIO	LR	LIPSTICK RED	MB	MIDNIGHT BLUE	MG	MEADOW GREEN	MK	MILK	MS	METALLIC SILVER	NK	NICKEL	OC	OCHRE	PY	PALE YELLOW	RO	RED ORANGE	RR	RUSTY RED	SB	SOFT BLUE	SD	SAND	TC	TERRACOTTA	TP	TAUPE	<p>7. Upholstery</p> <p>Polished Metal</p> <p>AL POLISHED ALUMINUM</p> <table border="1"> <tr> <td>81</td> <td>WHITE OAK</td> <td>+806</td> <td>+630</td> </tr> <tr> <td>83</td> <td>NATURAL MAPLE</td> <td>+694</td> <td>+568</td> </tr> <tr> <td>85</td> <td>WALNUT</td> <td>+908</td> <td>+694</td> </tr> </table> <p>Upholstery</p> <p>See general information section for details on textile program and COM/ COL information.</p> <p>Yardages provided are for non-directional fabrics that are applied railroaded. Directional fabrics may require additional yardage. Thick quilted fabrics will be need to be verified and may be handled as a custom order.</p>	81	WHITE OAK	+806	+630	83	NATURAL MAPLE	+694	+568	85	WALNUT	+908	+694
MT11	SINGLE																																																																																															
MT12	DOUBLE																																																																																															
MT13	TRIPLE																																																																																															
MT14	CORNER																																																																																															
MT15	CHAISE																																																																																															
W3 Low Back, Single Seat	+82																																																																																															
W3 Low Back, Double Seat	+164																																																																																															
W3 Low Back, Triple Seat	+245																																																																																															
W3 Low Back, Corner	+121																																																																																															
W3 Low Back, Chaise	+121																																																																																															
Low Back, Single Seat: 1.6 yds Back: 1.5 yds	Low Back, Corner Seat: 1.6 yds Back: 2.4 yds																																																																																															
Low Back, Double Seat: 2.6 yds Back: 2.2 yds	Low Back, Chaise Seat: 2.4 yds Back: 1.5 yds																																																																																															
Low Back, Triple Seat: 3.6 yds Back: 3.3 yds																																																																																																
A	CAST ALUMINUM LEG WITH ADJUSTABLE GLIDE																																																																																															
W	WOOD LEG WITH ADJUSTABLE GLIDE																																																																																															
BL	BLUE																																																																																															
BM	BLACK MATTE																																																																																															
CP	CHAMPAGNE																																																																																															
DB	DARK BRONZE																																																																																															
DG	DARK GRAY																																																																																															
DP	DUSTY PINK																																																																																															
DS	DARK SAGE																																																																																															
LG	LIGHT GRAY																																																																																															
LL	LILAC GRAY																																																																																															
LP	LIGHT PISTACHIO																																																																																															
LR	LIPSTICK RED																																																																																															
MB	MIDNIGHT BLUE																																																																																															
MG	MEADOW GREEN																																																																																															
MK	MILK																																																																																															
MS	METALLIC SILVER																																																																																															
NK	NICKEL																																																																																															
OC	OCHRE																																																																																															
PY	PALE YELLOW																																																																																															
RO	RED ORANGE																																																																																															
RR	RUSTY RED																																																																																															
SB	SOFT BLUE																																																																																															
SD	SAND																																																																																															
TC	TERRACOTTA																																																																																															
TP	TAUPE																																																																																															
81	WHITE OAK	+806	+630																																																																																													
83	NATURAL MAPLE	+694	+568																																																																																													
85	WALNUT	+908	+694																																																																																													



Metrum

HIGH BACK LOUNGE, ARMLESS

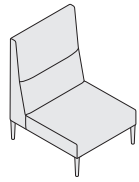
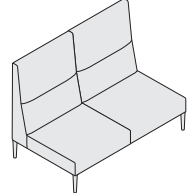
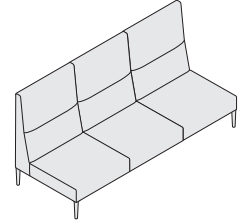
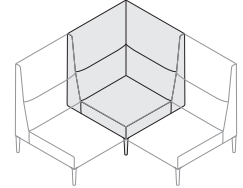
Textile Upholstery Grades

TITLE	SERIES	MODEL	DIMENSIONS	YDG	COM	A	B	C	D	E	F	G	H	I	J	K	L	M
High Back, Single 	MT	21	29.75W x 33.75D x 44.5H	3.3	2,772	3,020	3,153	3,285	3,421	3,558	3,708	3,852	4,027	4,255	4,526	4,796	5,063	5,332
High Back, Double 	MT	22	59.5W x 33.75D x 44.5H	6.2	4,787	5,256	5,505	5,756	6,005	6,264	6,545	6,817	7,145	7,574	8,082	8,590	9,090	9,599
High Back, Triple 	MT	23	89.25W x 33.75D x 44.5H	9	6,677	7,357	7,719	8,082	8,446	8,819	9,228	9,624	10,102	10,723	11,462	12,198	12,924	13,659
High Back, Corner 	MT	24	33.75W x 33.75D x 44.5H	5.2	4,283	4,676	4,885	5,095	5,304	5,521	5,757	5,986	6,261	6,622	7,047	7,472	7,892	8,318

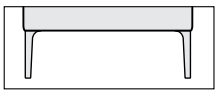
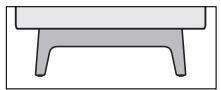
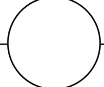
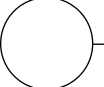
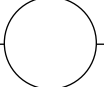
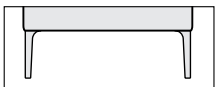
To Order Select Below

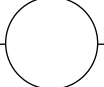
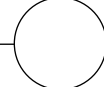
1. Series/Model	2. Welt Cord	3. Dual Upholstery	4. Power	5. Leg	6. Leg Finish	7. Upholstery																																																																																																								
 Metrum High Back <table border="1"> <tr><td>MT21</td><td>SINGLE</td></tr> <tr><td>MT22</td><td>DOUBLE</td></tr> <tr><td>MT23</td><td>TRIPLE</td></tr> <tr><td>MT24</td><td>CORNER</td></tr> </table>	MT21	SINGLE	MT22	DOUBLE	MT23	TRIPLE	MT24	CORNER	 Welt Cord <table border="1"> <tr><td>W3</td><td>WELT CORD ON SEATS & BACKS</td></tr> </table> <p>Requires an additional 0.25 yds of fabric. Not available on quilted fabric. Upcharges listed below:</p> <table border="1"> <tr><td>W3</td><td>High Back, Single Seat</td><td>+88</td></tr> <tr><td>W3</td><td>High Back, Double Seat</td><td>+177</td></tr> <tr><td>W3</td><td>High Back, Triple Seat</td><td>+265</td></tr> </table>	W3	WELT CORD ON SEATS & BACKS	W3	High Back, Single Seat	+88	W3	High Back, Double Seat	+177	W3	High Back, Triple Seat	+265	 Dual Upholstery <table border="1"> <tr><td>DF</td><td>SECOND TEXTILE ON SEAT</td></tr> </table> <p>When specifying In-Graded textiles, please apply the higher of the two grades.</p> <table border="1"> <tr> <td>High Back, Single Seat: 1.6 yds Back: 2.5 yds</td> <td>High Back, Corner Seat: 1.6 yds Back: 4.3 yds</td> </tr> <tr> <td colspan="2">High Back, Double Seat: 2.7 yds Back: 4.3 yds</td> </tr> <tr> <td colspan="2">High Back, Triple Seat: 3.0 yds Back: 6.2 yds</td> </tr> </table>	DF	SECOND TEXTILE ON SEAT	High Back, Single Seat: 1.6 yds Back: 2.5 yds	High Back, Corner Seat: 1.6 yds Back: 4.3 yds	High Back, Double Seat: 2.7 yds Back: 4.3 yds		High Back, Triple Seat: 3.0 yds Back: 6.2 yds		 Power <p>Refer to power ordering steps on page 7.</p>	 Leg <table border="1"> <tr><td>A</td><td>CAST ALUMINUM LEG WITH ADJUSTABLE GLIDE</td></tr> <tr><td>W</td><td>WOOD LEG WITH ADJUSTABLE GLIDE</td></tr> </table>  A  W	A	CAST ALUMINUM LEG WITH ADJUSTABLE GLIDE	W	WOOD LEG WITH ADJUSTABLE GLIDE	 Standard Powder Coated Metal <table border="1"> <tr><td>BL</td><td>BLUE</td></tr> <tr><td>BM</td><td>BLACK MATTE</td></tr> <tr><td>CP</td><td>CHAMPAGNE</td></tr> <tr><td>DB</td><td>DARK BRONZE</td></tr> <tr><td>DG</td><td>DARK GRAY</td></tr> <tr><td>DP</td><td>DUSTY PINK</td></tr> <tr><td>DS</td><td>DARK SAGE</td></tr> <tr><td>LG</td><td>LIGHT GRAY</td></tr> <tr><td>LL</td><td>LILAC GRAY</td></tr> <tr><td>LP</td><td>LIGHT PISTACHIO</td></tr> <tr><td>LR</td><td>LIPSTICK RED</td></tr> <tr><td>MB</td><td>MIDNIGHT BLUE</td></tr> <tr><td>MG</td><td>MEADOW GREEN</td></tr> <tr><td>MK</td><td>MILK</td></tr> <tr><td>MS</td><td>METALLIC SILVER</td></tr> <tr><td>NK</td><td>NICKEL</td></tr> <tr><td>OC</td><td>OCHRE</td></tr> <tr><td>PY</td><td>PALE YELLOW</td></tr> <tr><td>RO</td><td>RED ORANGE</td></tr> <tr><td>RR</td><td>RUSTY RED</td></tr> <tr><td>SB</td><td>SOFT BLUE</td></tr> <tr><td>SD</td><td>SAND</td></tr> <tr><td>TC</td><td>TERRACOTTA</td></tr> <tr><td>TP</td><td>TAUPE</td></tr> </table>	BL	BLUE	BM	BLACK MATTE	CP	CHAMPAGNE	DB	DARK BRONZE	DG	DARK GRAY	DP	DUSTY PINK	DS	DARK SAGE	LG	LIGHT GRAY	LL	LILAC GRAY	LP	LIGHT PISTACHIO	LR	LIPSTICK RED	MB	MIDNIGHT BLUE	MG	MEADOW GREEN	MK	MILK	MS	METALLIC SILVER	NK	NICKEL	OC	OCHRE	PY	PALE YELLOW	RO	RED ORANGE	RR	RUSTY RED	SB	SOFT BLUE	SD	SAND	TC	TERRACOTTA	TP	TAUPE	 Upholstery <p>See general information section for details on textile program and COM/ COL information.</p> <table border="1"> <tr> <td>Polished Metal</td> <td>AL</td> <td>POLISHED ALUMINUM</td> <td></td> <td></td> </tr> <tr> <td>Wood</td> <td></td> <td></td> <td>Chair</td> <td>Corner</td> </tr> <tr> <td>81</td> <td>WHITE OAK</td> <td></td> <td>+806</td> <td>+630</td> </tr> <tr> <td>83</td> <td>NATURAL MAPLE</td> <td></td> <td>+694</td> <td>+568</td> </tr> <tr> <td>85</td> <td>WALNUT</td> <td></td> <td>+908</td> <td>+694</td> </tr> </table> <p>Yardages provided are for non-directional fabrics that are applied railroaded. Directional fabrics may require additional yardage. Thick quilted fabrics will be need to be verified and may be handled as a custom order.</p>	Polished Metal	AL	POLISHED ALUMINUM			Wood			Chair	Corner	81	WHITE OAK		+806	+630	83	NATURAL MAPLE		+694	+568	85	WALNUT		+908	+694
MT21	SINGLE																																																																																																													
MT22	DOUBLE																																																																																																													
MT23	TRIPLE																																																																																																													
MT24	CORNER																																																																																																													
W3	WELT CORD ON SEATS & BACKS																																																																																																													
W3	High Back, Single Seat	+88																																																																																																												
W3	High Back, Double Seat	+177																																																																																																												
W3	High Back, Triple Seat	+265																																																																																																												
DF	SECOND TEXTILE ON SEAT																																																																																																													
High Back, Single Seat: 1.6 yds Back: 2.5 yds	High Back, Corner Seat: 1.6 yds Back: 4.3 yds																																																																																																													
High Back, Double Seat: 2.7 yds Back: 4.3 yds																																																																																																														
High Back, Triple Seat: 3.0 yds Back: 6.2 yds																																																																																																														
A	CAST ALUMINUM LEG WITH ADJUSTABLE GLIDE																																																																																																													
W	WOOD LEG WITH ADJUSTABLE GLIDE																																																																																																													
BL	BLUE																																																																																																													
BM	BLACK MATTE																																																																																																													
CP	CHAMPAGNE																																																																																																													
DB	DARK BRONZE																																																																																																													
DG	DARK GRAY																																																																																																													
DP	DUSTY PINK																																																																																																													
DS	DARK SAGE																																																																																																													
LG	LIGHT GRAY																																																																																																													
LL	LILAC GRAY																																																																																																													
LP	LIGHT PISTACHIO																																																																																																													
LR	LIPSTICK RED																																																																																																													
MB	MIDNIGHT BLUE																																																																																																													
MG	MEADOW GREEN																																																																																																													
MK	MILK																																																																																																													
MS	METALLIC SILVER																																																																																																													
NK	NICKEL																																																																																																													
OC	OCHRE																																																																																																													
PY	PALE YELLOW																																																																																																													
RO	RED ORANGE																																																																																																													
RR	RUSTY RED																																																																																																													
SB	SOFT BLUE																																																																																																													
SD	SAND																																																																																																													
TC	TERRACOTTA																																																																																																													
TP	TAUPE																																																																																																													
Polished Metal	AL	POLISHED ALUMINUM																																																																																																												
Wood			Chair	Corner																																																																																																										
81	WHITE OAK		+806	+630																																																																																																										
83	NATURAL MAPLE		+694	+568																																																																																																										
85	WALNUT		+908	+694																																																																																																										

Metrum

SETTEE & BENCH

Textile Upholstery Grades

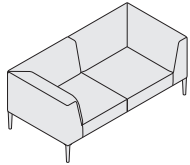
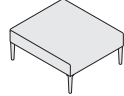
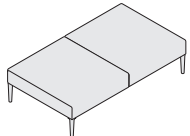
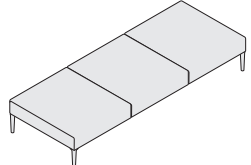
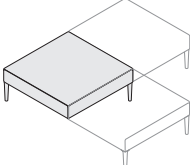
TITLE	SERIES	MODEL	DIMENSIONS	YDG	COM	A	B	C	D	E	F	G	H	I	J	K	L	M
Settee 	MT	32	67W x 33.75D x 28H	6.6	5,290	5,790	6,055	6,321	6,588	6,861	7,162	7,452	7,801	8,259	8,799	9,339	9,873	10,414
Bench, Single 	MT	01	29.75W x 33.75D x 16H	2.1	1,480	1,639	1,723	1,808	1,894	1,980	2,076	2,168	2,279	2,425	2,597	2,770	2,938	3,110
Bench, Double 	MT	02	59.5W x 33.75D x 16H	3	2,519	2,746	2,866	2,988	3,109	3,233	3,370	3,502	3,661	3,869	4,114	4,361	4,603	4,847
Bench, Triple 	MT	03	89.25W x 33.75D x 16H	4.1	3,402	3,711	3,875	4,040	4,208	4,376	4,565	4,743	4,961	5,246	5,582	5,918	6,247	6,583
Bench, Corner 	MT	04	33.75W x 33.75D x 16H	2.2	1,511	1,679	1,766	1,855	1,944	2,035	2,136	2,232	2,348	2,501	2,681	2,861	3,038	3,219

To Order Select Below

1. Series/Model

Metrum Settee

MT32 SETTEE

Metrum Bench

MT01 SINGLE
MT02 DOUBLE
MT03 TRIPLE
MT04 CORNER

2. Welt Cord

W3 WELT CORD ON SEATS & BACKS
W1 WELT CORD ON SEATS

Requires an additional 0.25 yds of fabric. Not available on quilted fabric. Upcharges listed below:

W3 Settee +288
W1 Bench, Single Seat +63
W1 Bench, Double Seat +127
W1 Bench, Triple Seat +190

3. Settee Dual Upholstery

DF SECOND TEXTILE ON SEAT

When specifying In-Graded textiles, please apply the higher of the two grades.

Settee
Seat: 2.4 yds
Back: 4.4 yds

3. Power

Refer to power ordering steps on page 7.

4. Leg

A CAST ALUMINUM LEG WITH ADJUSTABLE GLIDE
W WOOD LEG WITH ADJUSTABLE GLIDE



5. Leg Finish

Standard Powder Coated Metal

BL BLUE
BM BLACK MATTE
CP CHAMPAGNE
DB DARK BRONZE
DG DARK GRAY
DP DUSTY PINK
DS DARK SAGE
LG LIGHT GRAY
LL LILAC GRAY
LP LIGHT PISTACHIO
LR LIPSTICK RED
MB MIDNIGHT BLUE

MG MEADOW GREEN
MK MILK
MS METALLIC SILVER
NK NICKEL
OC OCHRE
PY PALE YELLOW
RO RED ORANGE
RR RUSTY RED
SB SOFT BLUE
SD SAND
TC TERRACOTTA
TP TAUPE

6. Upholstery

Polished Metal

AL POLISHED ALUMINUM

Wood

81 WHITE OAK +806
83 NATURAL MAPLE +694
85 WALNUT +908

Upholstery



See general information section for details on textile program and COM/ COL information.

Yardages provided are for non-directional fabrics that are applied railroaded. Directional fabrics may require additional yardage. Thick quilted fabrics will be need to be verified and may be handled as a custom order.

Metrum

MODULAR ARM, UPHOLSTERED

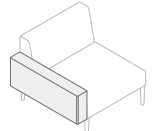
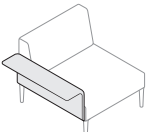
Textile Upholstery Grades

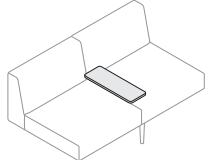
TITLE	SERIES	MODEL	DIMENSIONS	YDG	COM	A	B	C	D	E	F	G	H	I	J	K	L	M
Standard Arm 	MT	44	5.75W x 33.75D x 13H	1.5	466	580	640	701	761	825	891	958	1,038	1,141	1,264	1,387	1,508	1,631
Cantilever Arm 	MT	41	9.13W x 33.75D x 13.5H	0.9	630	675	700	723	748	772	800	827	857	899	948	998	1,047	1,096
Privacy Arm 	MT	43	2W x 33.75D x 12H	1.7	378	506	574	643	712	783	859	935	1,023	1,142	1,282	1,421	1,558	1,696
Mid Arm, Upholstered 	MT	46	8W x 22.5D	1.1	630	713	757	802	847	891	941	990	1,048	1,125	1,215	1,305	1,394	1,484

To Order Select Below

1. Series/Model

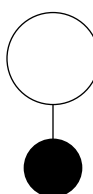

Metrum Modular Arm, Upholstered

- MT44 STANDARD ARM
- MT41 CANTILEVER ARM
- MT43 PRIVACY ARM
- MT46 MID ARM, UPHOLSTERED

2. Arm Orientation

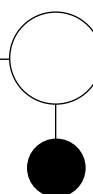

Arm Orientation

- L LEFT ORIENTATION WHEN SEATED
- R RIGHT ORIENTATION WHEN SEATED

Arm orientation applies to Standard, Cantilever, and Privacy Arms. Mid Arm is non-handed.

3. Cantilever Arm Finish

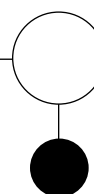

Standard Powder Coated Metal

- | | |
|--------------------|--------------------|
| BL BLUE | MG MEADOW GREEN |
| BM BLACK MATTE | MK MILK |
| CP CHAMPAGNE | MS METALLIC SILVER |
| DB DARK BRONZE | NK NICKEL |
| DG DARK GRAY | OC OCHRE |
| DP DUSTY PINK | PY PALE YELLOW |
| DS DARK SAGE | RO RED ORANGE |
| LG LIGHT GRAY | RR RUSTY RED |
| LL LILAC GRAY | SB SOFT BLUE |
| LP LIGHT PISTACHIO | SD SAND |
| LR LIPSTICK RED | TC TERRACOTTA |
| MB MIDNIGHT BLUE | TP TAUPE |

4. Welt Cord

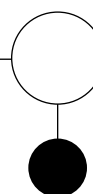

Welt Cord

- W4 WELT CORD ON ARM **+63**

Requires an additional 0.25 yds of fabric.
Applies to Standard Arm only.
Not available on quilted fabric.

5. Upholstery

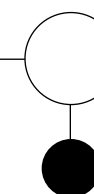

Upholstery

See general information section for details on textile program and COM/COL information.

Yardages provided are for non-directional fabrics that are applied railroaded. Directional fabrics may require additional yardage. Thick quilted fabrics will be need to be verified and may be handled as a custom order.

Metrum

MODULAR ARM, WOOD

Solid Wood Selections

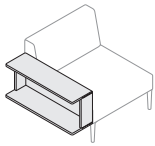
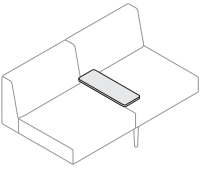
TITLE	SERIES	MODEL	WOOD	DIMENSIONS	LIST PRICE	
Bookshelf Arm 	White Oak	MT	42	SW81	10W x 33D x 14H	2,267
	Natural Maple	MT	42	SW83	10W x 33D x 14H	2,519
	Walnut	MT	42	SW85	10W x 33D x 14H	3,023
Mid Arm, Wood 	White Oak	MT	45	SW81	7.5W x 22D	977
	Natural Maple	MT	45	SW83	7.5W x 22D	1,008
	Walnut	MT	45	SW85	7.5W x 22D	1,134

To Order Select Below

1. Series/Model

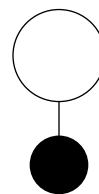

Metrum
Modular Arm, Wood

- MT42 BOOKSHELF ARM
- MT45 MID ARM, WOOD

2. Bookshelf Arm Orientation

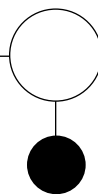

Bookshelf Arm Orientation

- L LEFT ORIENTATION WHEN SEATED
- R RIGHT ORIENTATION WHEN SEATED

Arm orientation applies to Bookshelf Arm.
Mid Arm is non-handed.

3. Arm Finish

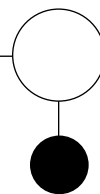

Wood

- SW81 WHITE OAK
- SW83 NATURAL MAPLE
- SW85 WALNUT

Metrum

TABLE

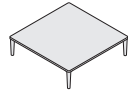
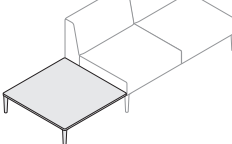
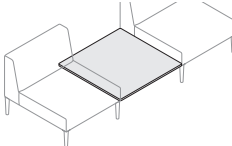
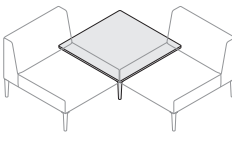
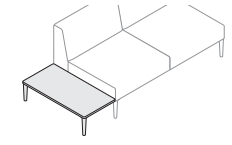
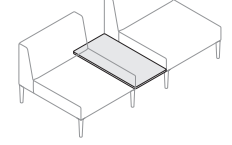
TITLE	SERIES	MODEL	DIMENSIONS	Caesarstone Top Selections				Solid Surface Top Selections						Solid Wood Top Selections		
				CS51	CS52	CS65	CS96	SS01	SS03	SS04	SS05	SS06	SW81	SW83	SW85	
Full Table, Stand Alone 	MT	51	33.5W x 33.5D x 9.5H	4,787	4,787	6,173	7,810	2,519	2,519	3,212	4,283	3,779	1,650	1,486	2,242	
Full Table, End 	MT	52	33.5W x 33.5D x 9.5H	4,660	4,660	6,046	7,684	2,393	2,393	3,086	4,157	3,652	1,524	1,359	2,116	
Full Table, Mid 	MT	53	33.5W x 33.5D x 9.5H	4,660	4,660	6,046	7,684	2,393	2,393	3,086	4,157	3,652	1,524	1,359	2,116	
Full Table, Corner 	MT	54	33.5W x 33.5D x 9.5H	4,787	4,787	6,173	7,810	2,519	2,519	3,212	4,283	3,779	1,650	1,486	2,242	
Half Table, End 	MT	56	20W x 33.5D x 9.5H	4,473	4,473	5,104	5,165	1,953	1,953	2,457	3,402	3,087	1,109	1,008	1,500	
Half Table, Mid 	MT	57	20W x 33.5D x 9.5H	4,473	4,473	5,104	5,165	1,953	1,953	2,457	3,402	3,087	1,109	1,008	1,500	

To Order Select Below

1. Series/Model

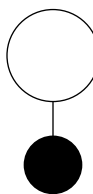

Metrum Full Table

MT51	STAND ALONE
MT52	END
MT53	MID
MT54	CORNER

Metrum Half Table

MT56	END
MT57	MID

2. Table Top

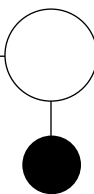

Caesarstone

CS51	JET BLACK
CS52	SLEEK CONCRETE
CS65	PURE WHITE
CS96	STATUARIO NUVO

Solid Surface

SS01	ARCTIC WHITE
SS03	IVORY WHITE
SS04	GREY
SS05	STEEL GREY
SS06	BLACK

Solid Wood

SW81	WHITE OAK
SW83	NATURAL MAPLE
SW85	WALNUT

3. Power

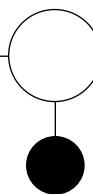

Power

Refer to power ordering steps on page 7.

4. Table Leg

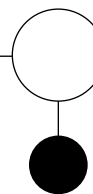
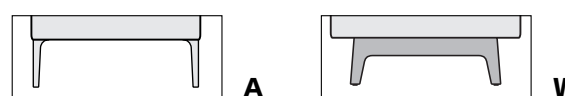
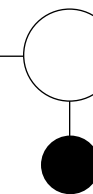

Table Leg

A	CAST ALUMINUM LEG WITH ADJUSTABLE GLIDE
W	WOOD LEG WITH ADJUSTABLE GLIDE



5. Table Leg Finish



Standard Powder Coated Metal

BL	BLUE
BM	BLACK MATTE
CP	CHAMPAGNE
DB	DARK BRONZE
DG	DARK GRAY
DP	DUSTY PINK
DS	DARK SAGE
LG	LIGHT GRAY
LL	LILAC GRAY
LP	LIGHT PISTACHIO
LR	LIPSTICK RED
MB	MIDNIGHT BLUE
MG	MEADOW GREEN
MK	MILK
MS	METALLIC SILVER
NK	NICKEL
OC	OCHRE
PY	PALE YELLOW
RO	RED ORANGE
RR	RUSTY RED
SB	SOFT BLUE
SD	SAND
TC	TERRACOTTA
TP	TAUPE

Polished Metal

AL	POLISHED ALUMINUM
----	-------------------

Wood

81	WHITE OAK	+806
83	NATURAL MAPLE	+694
85	WALNUT	+908