

stylex

Trim

PRICE LIST

Effective November 01, 2023

General Information

STYLEX PRICE LIST

GENERAL INFORMATION

Terms

Net 30 days from date of invoice,
F. O. B . Delanco, New Jersey.

Damaged Shipments

All Stylex products are carefully inspected before they are packed in sturdy cartons designed to satisfy shipping requirements. Stylex is not responsible for damage in shipment. The transportation company assumes responsibility for delivering products to you in good condition when the bill of lading is signed. You protect yourself by refusing shipments showing damage or shortage until transportation company has noted on the delivery sheet the extent of damage or shortage. Concealed damage should be reported to the carrier as soon as discovered, but no later than 5 days after receiving shipment.

Return/Restocking Policy

Return shipments will not be accepted unless specifically authorized by Stylex in writing. The Return Authorization number should be clearly marked on the carton. The customer returning Stylex products is responsible for return shipping costs. Merchandise must be returned unused. Returned merchandise is subject to a 35% restocking fee.

Special Products

Modifications to standard products will be considered for large runs. Contact factory for price quotations.

Design Changes

In keeping with modern manufacturing advances, Stylex reserves the right to incorporate minor modifications and design changes in products without notice.

Cancellation/Change Order Policy

Regarding requests for order cancellation and/or order modification, please be advised that no charges will be applied before production, unless inventory has been specifically requisitioned to fulfill your order. Once orders proceed to the production phase, they cannot be altered or canceled under any circumstances. All requests for order cancellations or order changes must be submitted in writing and will only be considered valid upon approval by Stylex.

WARRANTY

Except as provided below, Stylex warrants exclusively to the original Purchaser of our product that all parts, under normal use and service, will be free from defects in workmanship and material for a period of ten (10) years from the date of purchase. "Normal use and service" means that the product will be used in a typical office environment for 40-45 hours per week.

This warranty is subject to the following limitations, exclusions and provisions:

Limitations involving materials and components:

Wood components of plywood stacking chairs
(such as Brooks and Welcome)
5 years

Upholstery

(including mesh used for Click, F4, Insight, and Zephyr Mesh)
3 years

SAVA Mesh

10 years

Pneumatic Cylinders

3 years

COM Upholstery

No warranty
Stylex makes every effort to ensure that the COM Upholstery it approves is suitable for the intended use. Nevertheless, we will not warrant, and assume no responsibility for, the durability or tailoring quality of any COM or COL . If you have any concerns about the ultimate appearance of any covering, please order an upholstered sample.

Painted Stack Chair Frames

No Warranty
We will not warrant the finish of painted stack chair frames against damage from stacking. Please order chrome frames for chairs that will be stacked.

Felt Glides

No warranty
Due to the different surfaces on which felt glides may be used, we cannot warrant their durability over time.

If this product fails during normal use and service within the applicable warranty period (other than through normal wear and tear), please submit a warranty claim at stylexdesign.com/warranty-claim/. Quantity, model details, description of issue, and Stylex certified labels are required for submission. PLEASE DO NOT RETURN PARTS OR THE PRODUCT TO STYLEX UNLESS INSTRUCTED TO DO SO BY STYLEX. Stylex will, at its discretion, either repair or replace the defective product or part at no cost. Labor requests must receive approval and will be authorized on a case-by-case basis. We will only reimburse for labor costs directly incurred, excluding any travel-related expenses. Purchaser may be required (at the option of Stylex) to return to Stylex at Purchaser's expense any defective part with all freight or shipping charges prepaid. The foregoing warranty shall be void if the product has been altered or repaired (other than by Stylex). The warranty does not cover damage to the product caused by accident, neglect, misuse, abuse, modification to the product by anyone other than Stylex or damage caused by use of the product for a purpose other than that for which it was designed. This warranty extends only to the original Purchaser of the product.

No Other Warranties

This warranty is in lieu of all other warranties, expressed or implied, including, but not limited to, implied warranties of merchantability and fitness for a particular purpose. The rights and remedies provided herein are the exclusive rights and remedies of the original purchaser of the product.

No Liability For Damages

In no event shall Stylex or its suppliers be responsible or liable for any special, indirect, consequential, or incidental damages. In no event shall the liability of Stylex exceed the actual purchase price paid to Stylex for the product.

Out of Warranty Products

For all products no longer covered by our warranty, please refer to our Design for Durability and Upgradability Policy. Contact your Account Manager if you would like to purchase any replaceable components to further extend the life of any Stylex seating product. This warranty applies to all Stylex products purchased on April 13, 2018, and thereafter.

PRODUCT TAKE BACK PROGRAM

In order to be good stewards of our products, Stylex offers a pathway towards a Product Take Back Program as a more viable solution to the end of our products' originally intended life.

Stylex supports the sustainable programs of ANEW and offers their added value to our clients through a comprehensive take-back solution for surplus office furniture and materials of any kind, in any condition. ANEW is a 501(c)(3) non-profit organization that exists to provide companies with smart, cost effective alternatives for their surplus furniture and other items with the priority of matching it to non- profits, public agencies and the underserved, within the local community of the project site. Corporate Social Responsibility is raised while the impact on the environment is lowered by diverting products and materials otherwise destined for landfill.

Stylex is proud to offer ANEW to customers dedicated to strengthening their community network by repurposing their furniture, fixtures and architectural materials to those in need. In 2014, Stylex committed to making this relationship a part of our strategic sales strategy. Visit www.anewfound.org to find out more.

To initiate a Product Take Back strategy through ANEW, contact Stylex Account Management at 800-257-5742.

For other end of life recovery options, please see our Product Disassembly Instructions and End of Life Recovery Options documents available on our website in the resources section of each product in our line.

FREIGHT PROGRAM

Freight charges will be calculated as a percentage of the net product price and added to the invoice at the time of shipment. The continental United States has been divided into three zones. Please use the map below to determine freight charges for the product's destination. Minimum freight charge is \$250. Please let us know if you will be shipping to a residential address or require inside delivery as this requires an additional fee. Also please note we need to be made aware if a liftgate is required prior to delivery. If any requests are made at the time of delivery, applicable charges will apply.



ZONE 1 - 4%

Connecticut
Delaware
New York
New Jersey
Maryland
Massachusetts
North Carolina
Ohio
Pennsylvania
Rhode Island
Virginia
Washington D.C.
West Virginia

ZONE 2 - 5%

Alabama
Arkansas
Canada, Ontario
Canada, Quebec
Florida
Georgia
Iowa
Illinois
Indiana
Kansas
Kentucky
Louisiana
Nebraska
New Hampshire
Oklahoma
Maine
Michigan
Minnesota
Missouri
Mississippi
South Carolina
Tennessee
Texas
Vermont
Wisconsin

ZONE 3 - 6%

Arizona
California
Colorado
Idaho
Montana
Nevada
New Mexico
North Dakota
Oregon
South Dakota
Utah
Washington
Wyoming

Quote Per Project
Alaska
Hawaii
Canada
(outside Ontario & Quebec)
Mexico

General Information

STYLEX PRICE LIST

TEXTILE PARTNERS & APPROVALS

Textile Partners

To customize your furniture performance needs and design vision, Stylex offers a wide selection of in-graded leathers and textiles from Grades A through Y. We've partnered with leading manufacturers on the options, focusing on color, price, durability, and construction. To view our partners and explore our digital carded program with broadly approved textiles, visit [this page](#). We stand by these textiles: They're tried and tested, and will effortlessly fit into any design aesthetic.

Textile Approvals

All textiles must be approved for the product you are specifying. For the related approved textile lists, visit [this page](#).

CAL 117 AND 133 COMPLIANCE

CAL 117-2013

CAL 117-2013 compliance is a requirement for all textiles applied on our seating products. All Stylex seating products meet this standard.

CAL 133

Most Stylex seating can be ordered to meet the requirements of CAL 133. When ordering, simply specify "CAL 133 compliance required". The upcharge for this option is \$54 list per yard. Please refer to the COM yardage of each model to determine the number of yards required. We do frequently require full-scale burn tests in order to certify CAL 133 before an order will be accepted. Such burn tests may increase normal lead times and do carry additional charges. Please contact your Stylex account manager for details.

CUSTOMER'S OWN MATERIAL/LEATHER

Customer's own material (COM) and customer's own leather (COL) will generally be upholstered at the price designated in each product's price list. Please be advised, however, that we specifically reserve the right to charge a higher price when we determine that special circumstances, such as unusual repeats or challenging materials, present themselves. All orders for custom coverings must be approved by Stylex before they will be accepted for production. To submit proposed textile for approval, please use the COM form [here](#).

Special Note:

We assume no responsibility for the durability or tailoring quality of any COM or COL. Directional covers in particular may not meet your satisfaction due to the design of certain products. Please be advised that COM and COL orders are not subject to return. If you have doubts about the ultimate appearance of certain coverings, please order a sample done with that specific COM or COL. In addition, while we inspect fabrics for mill imperfections, some are difficult to recognize. We cannot be responsible for defects, color inaccuracies, dye lot variations, or other flaws.

Under no circumstances will we be responsible for COM shortages, flaws, or other such problems. Finally, it is not our responsibility to police the receipt of COM's in order to meet delivery deadlines, and we assume our customers are aware of any undue delay in the shipment of their COM fabrics.

COM fabric and COL leather should be sent prepaid to: Stylex

**Attn: COM/COL - [Your Stylex PO #]
740 Coopertown Road
Delanco, NJ 08075**

All COM/COL sent to Stylex must be accompanied with a packing list which indicates the dealers' name, Stylex corresponding PO number, sales order number, COM/COL supplier name, textile pattern, colorway and shipped quantity. Stylex requires COM to be sent in as continuous yardage in the same dielot.

Yardage requirements shown in the price list are based on non-directional goods of 54" width. Fabrics less than 54" wide or those requiring matching (stripes, prints, or large patterned designs) call for additional yardage. We will be happy to supply yardage requirements for large quantities where economies may be realized.

Add the following yardage for stripes, plaids, or patterns with repeats:

Fabric Width	Plain Fabric	2-14" Repeat	15-24" Repeat	25-27" Repeat	28-36" Repeat
54"	0%	10%	15%	20%	25%
50"	10%	20%	25%	30%	35%
48"	15%	25%	30%	35%	40%
45"	40%	50%	55%	60%	65%
36"	50%	60%	65%	70%	75%

COM/COL FORM

To avoid delay in processing COM orders we request that you submit a sample of your COM textile stapled to this form which can be downloaded [here](#). If a textile has a stripe or design, the size of the repeat should be indicated. Please indicate the textile supplier's name, textile number, and color. Also indicate the Stylex product on which the textile will be used. If a certain direction of application is required, please ensure that information is communicated directly to your Stylex account manager.

The fabric supplier must indicate on his shipping labels the dealer name and purchase order number as well as the Stylex model number.

Please Note:

No order may be entered into production or have a shipping date assigned until all related COM is received at the factory.



CENTER OF STRIPE OR DESIGN

TOP OF CHAIR	TOP OF CHAIR
--------------	--------------

1. Size of Repeat

2. Textile Supplier

3. Textile Number

4. Color

5. Stylex Product

Trim

Contents

<hr/>		<hr/>	
COLORS, MATERIALS, AND FINISHES	5	SIDE TABLE	10
<hr/>		<hr/>	
OVERVIEW AND DIMENSIONS	6	COFFEE TABLE	16
<hr/>		<hr/>	
TYPICALS	7	PULL-UP TABLE	21
<hr/>		<hr/>	
HOW TO ORDER	9		
<hr/>			

CLICK THE TITLES ABOVE TO NAVIGATE THROUGH THE DOCUMENT
PRODUCT HEADERS ON SUBSEQUENT PAGES LINK BACK TO THIS PAGE

Trim

COLORS, MATERIALS, AND FINISHES

POWDER COATED METAL FINISHES

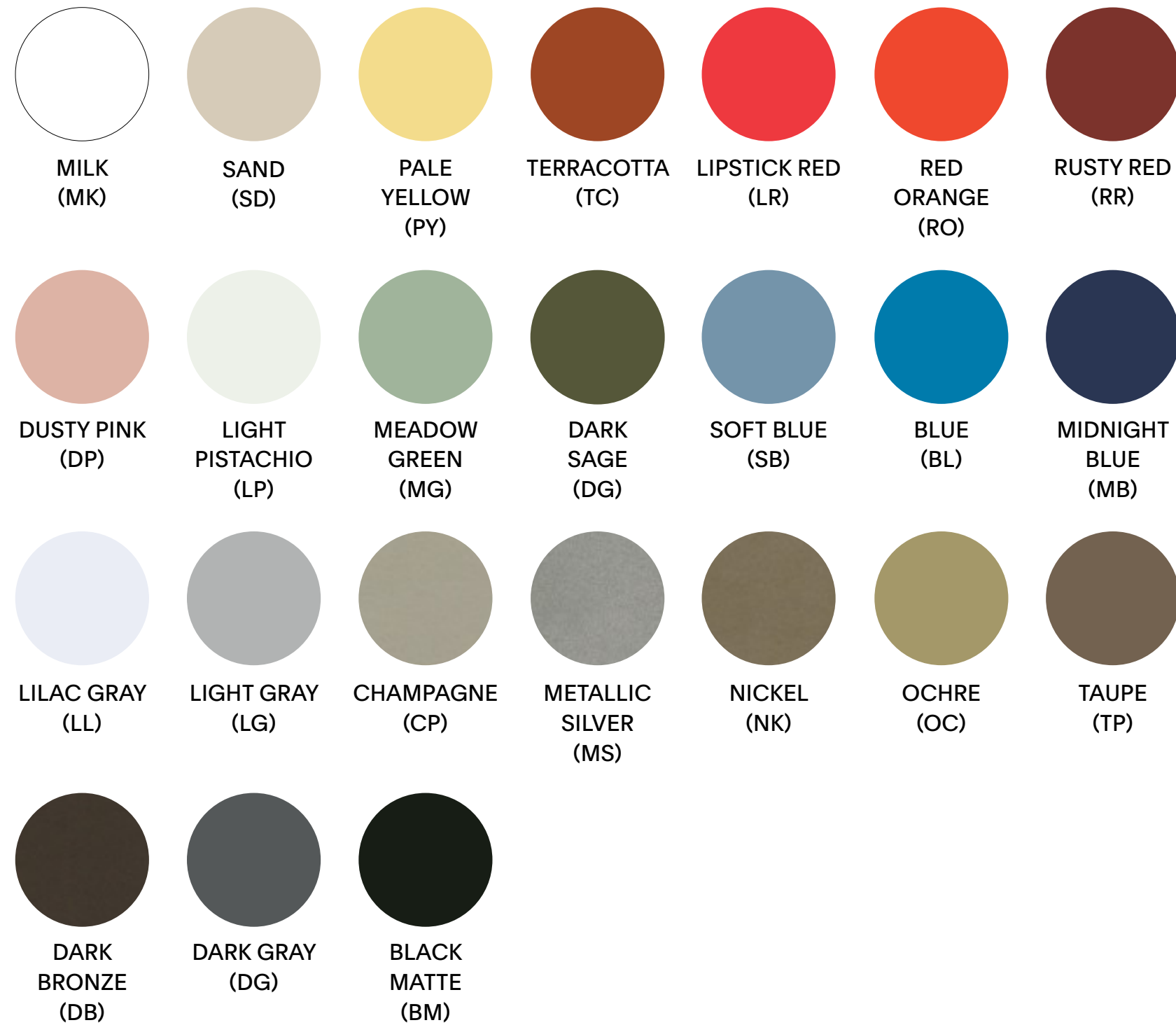

GRADE 1 LAMINATE FINISHES

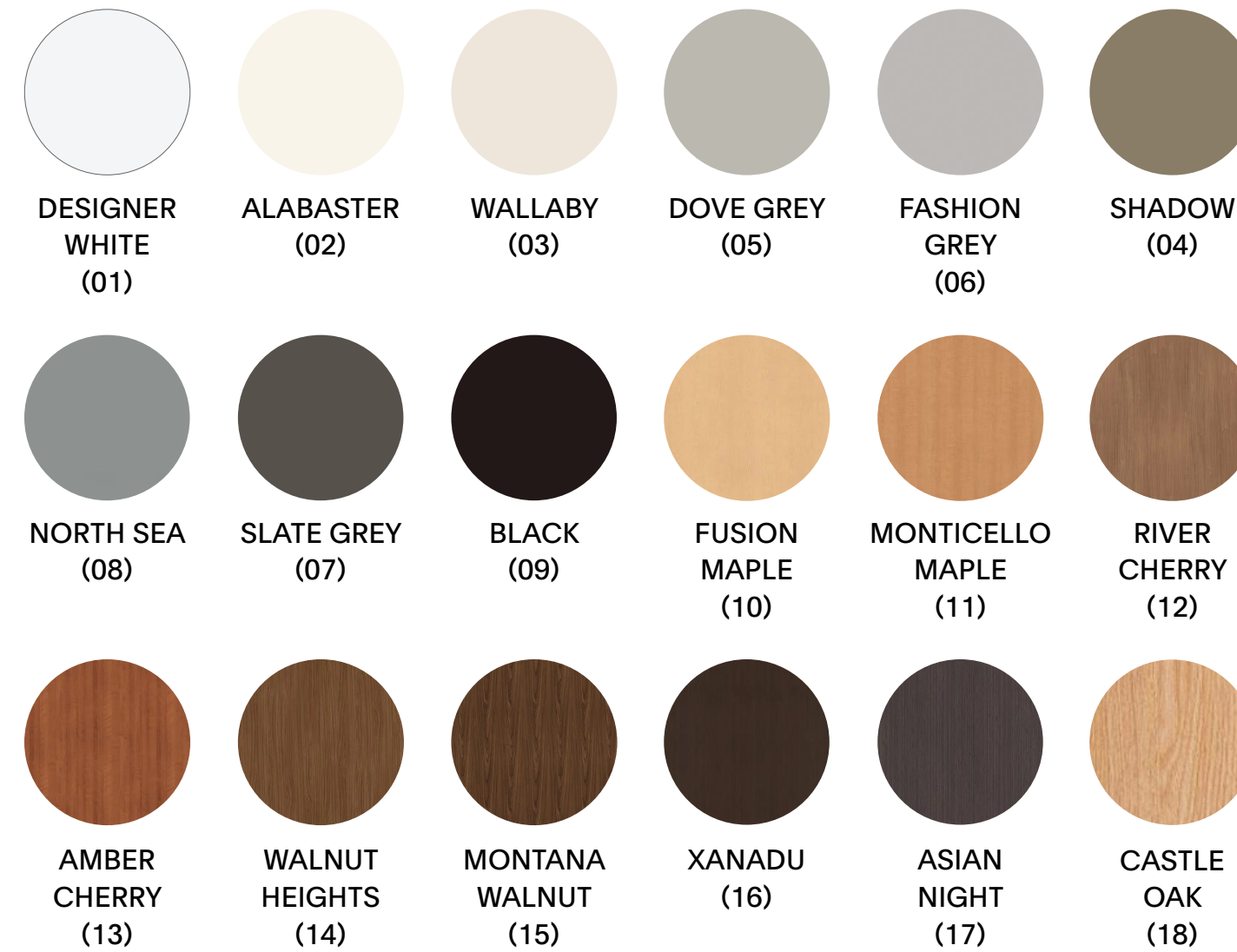

CAESARSTONE®

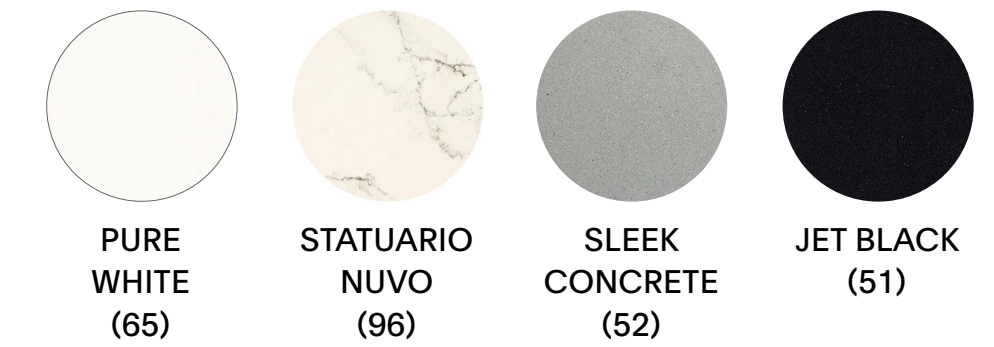

SOLID SURFACE



SOLID WOOD



BACK-PAINTED GLASS

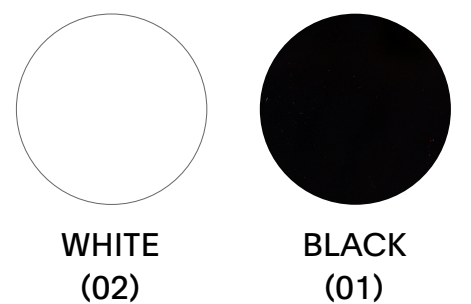

GRADE 2 LAMINATE FINISHES

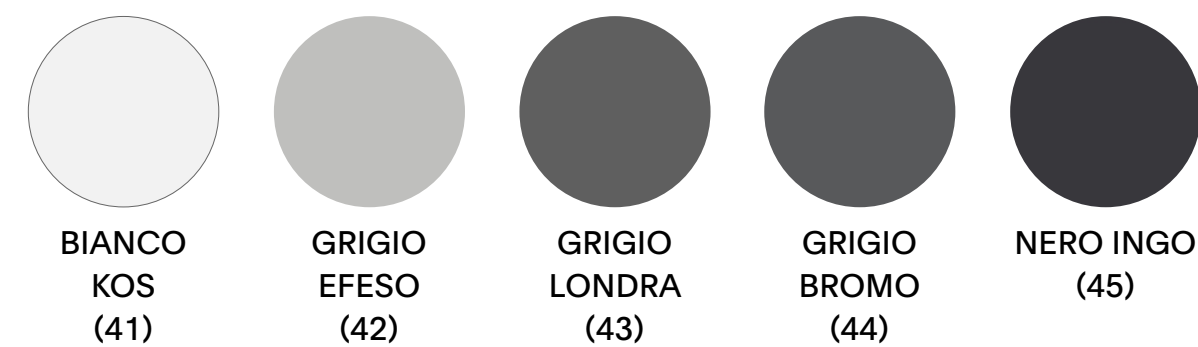

Trim

SPECIFICATION GUIDE: OVERVIEW AND DIMENSIONS

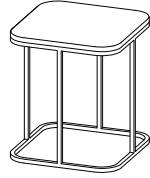
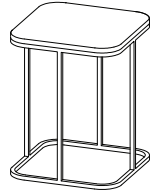
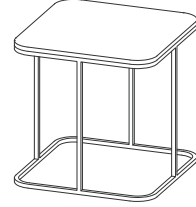
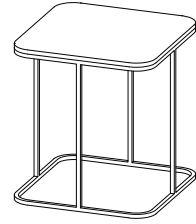
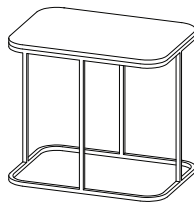
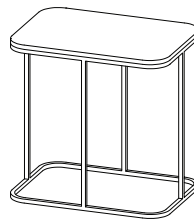
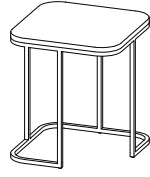
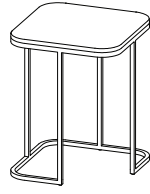
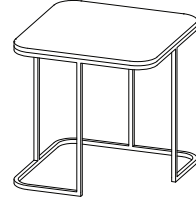
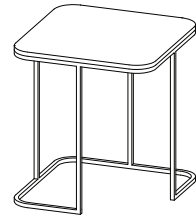
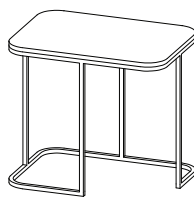
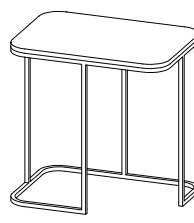
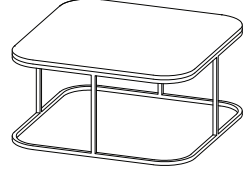
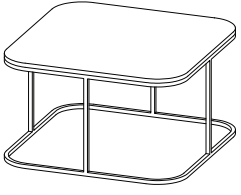
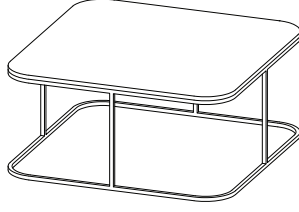
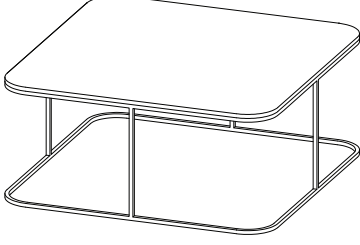
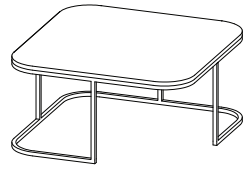
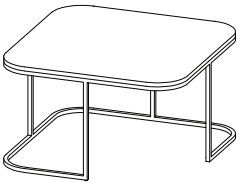
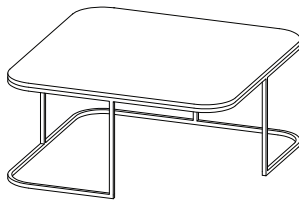
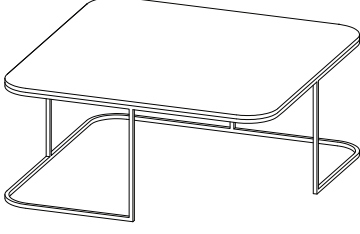
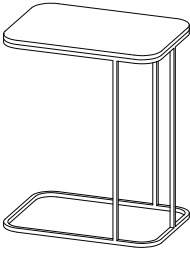
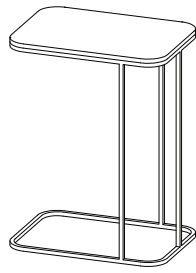
SIDE TABLES					
14D x 14W x 16H Closed 	14D x 14W x 18H Closed 	18D x 18W x 18H Closed 	18D x 18W x 20H Closed 	20D x 14W x 18H Closed 	20D x 14W x 20H Closed 
14D x 14W x 16H Open 	14D x 14W x 18H Open 	18D x 18W x 18H Open 	18D x 18W x 20H Open 	20D x 14W x 18H Open 	20D x 14W x 20H Open 
COFFEE TABLES					
24D x 24W x 12H Closed 	24D x 24W x 14H Closed 	30D x 30W x 14H Closed 	36D x 36W x 16H Closed 		
24D x 24W x 12H Open 	24D x 24W x 14H Open 	30D x 30W x 14H Open 	36D x 36W x 16H Open 		
PULL-UP TABLES					
20D x 14W x 24.5H Lounge 	20D x 14W x 26.5H Task 				

PRODUCT INFORMATION

Design
Chris Adamick

Bases
Trim bases are constructed from 1/2" square steel rod. The bottom frame loop is available in open and closed configurations, providing variations in appearance and nesting capability. Plastic glides are connected to the bottom surface of the frame. Attachment of tops is done through a simple hardware connection or adhesive-backed tape.

Tops
Tops vary in thickness, depending on top surface selection. Overall visible thickness of each top is 3/32" for Steel tops and 1/2" for all other options - Solid Wood, Caesarstone, Solid Surface, Back Painted Glass, and Laminate.

Use
Designed for indoor use only.

Performance Standards
Manufactured to comply with:
ANSI/BIFMA X5.5 Desk and Table Products

Certifications
GREENGUARD GOLD- Caesarstone, Glass, Metal, Solid Surface
GREENGUARD - Laminate, Solid Wood
LEVEL® 2

Trim

SPECIFICATION GUIDE: TYPICALS

GROUP 1 - SIDE NESTING, SMALL

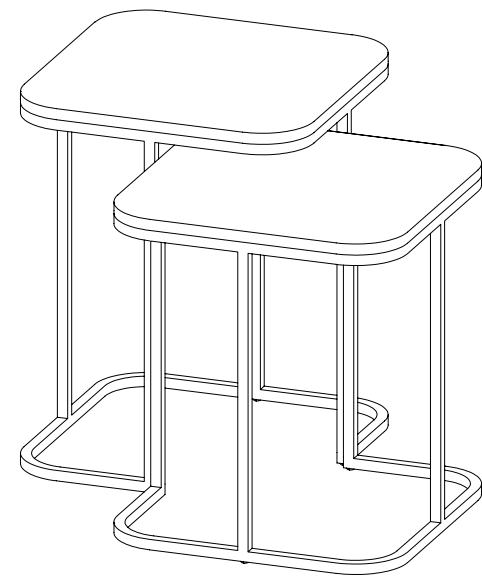

QTY	MODEL	DESCRIPTION	LIST
1	TR141416OMT	Side, 14D x 14W x 16H, Open	873
1	TR141418OMT	Side, 14D x 14W x 18H, Open	886

Total List Price 1,759

GROUP 2 - SIDE NESTING, LARGE

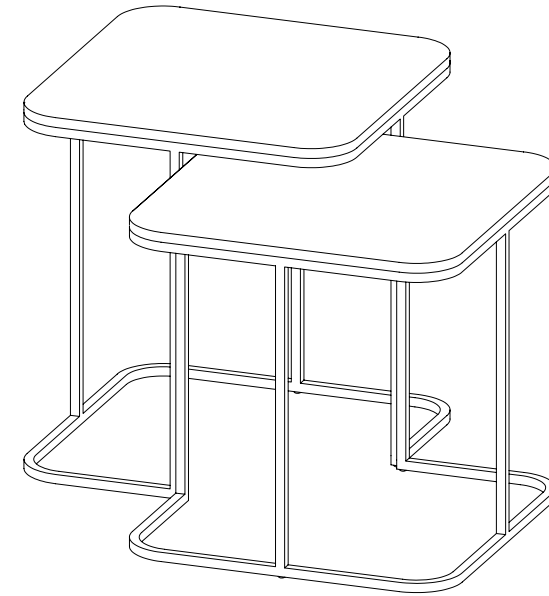

QTY	MODEL	DESCRIPTION	LIST
1	TR181818OMT	Side, 18D x 18W x 18H, Open	959
1	TR181820OMT	Side, 18D x 18W x 20H, Open	976

Total List Price 1,935

GROUP 3 - COFFEE NESTING, SMALL

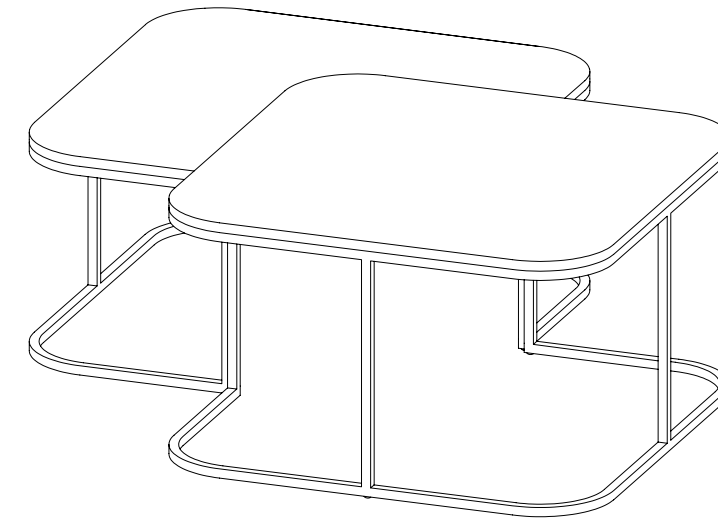

QTY	MODEL	DESCRIPTION	LIST
1	TR242412OMT	Coffee, 24D x 24W x 12H, Open	1,260
1	TR242414OMT	Coffee, 24D x 24W x 14H, Open	1,272

Total List Price 2,532

GROUP 4 - COFFEE NESTING, LARGE

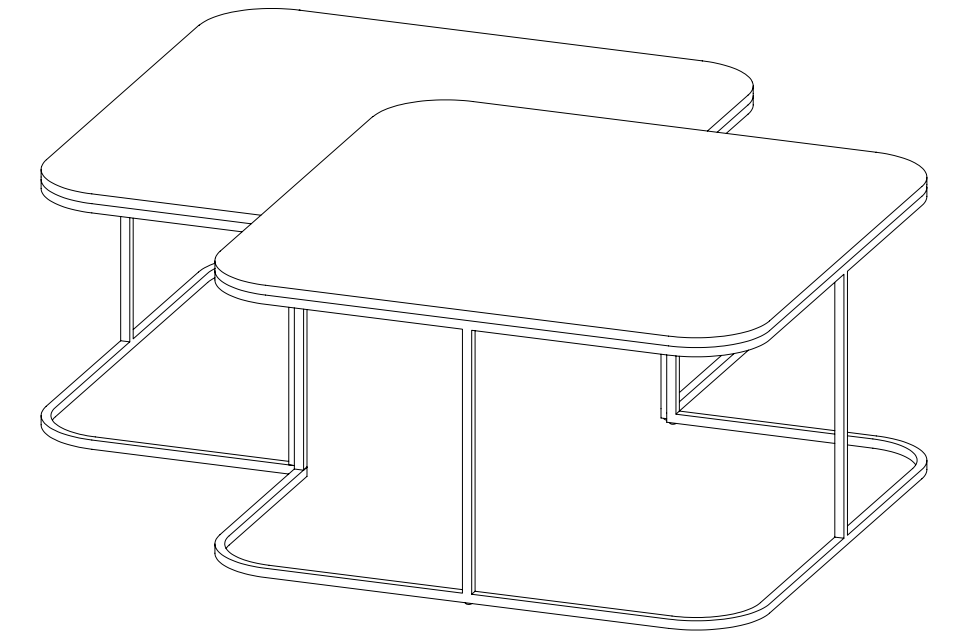

QTY	MODEL	DESCRIPTION	LIST
1	TR303014OMT	Coffee, 30D x 30W x 14H, Open	1,387
1	TR303016OMT	Coffee, 30D x 30W x 16H, Open	1,402

Total List Price 2,789

Trim

SPECIFICATION GUIDE: TYPICALS

GROUP 5 - SIDE NESTING, OPEN/CLOSED

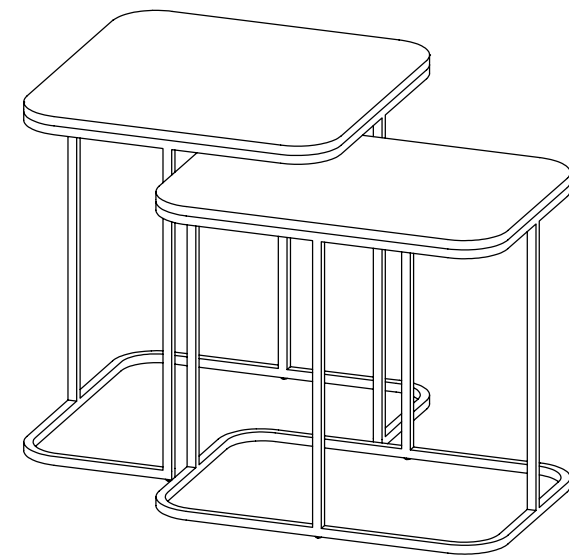

QTY	MODEL	DESCRIPTION	LIST
1	TR181820OMT	Side, 18D x 18W x 20H, Open	976
1	TR201418OMT	Side, 20D x 14W x 18H, Closed	986
Total List Price			1,962

GROUP 6 - COFFEE NESTING, OPEN/CLOSED

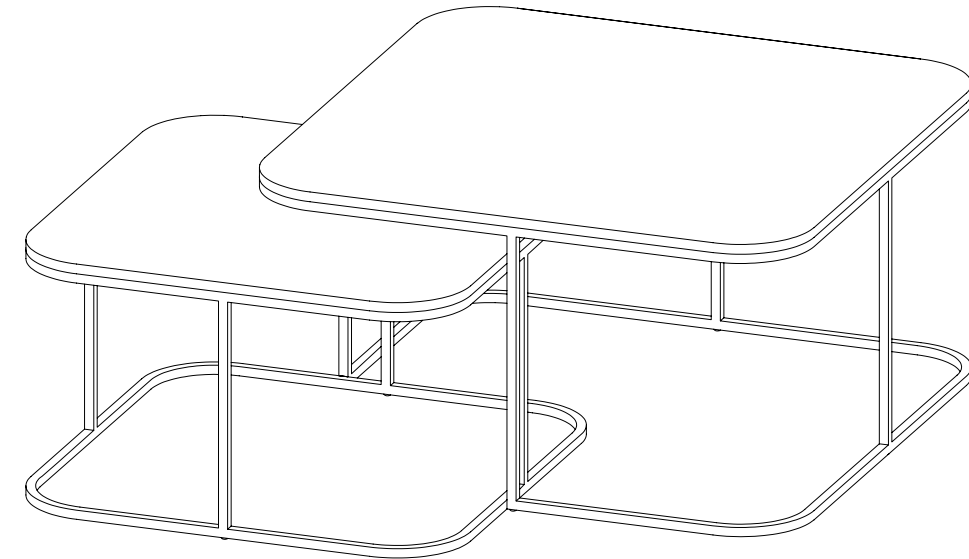

QTY	MODEL	DESCRIPTION	LIST
1	TR303016OMT	Coffee, 30D x 30W x 16H, Open	1,402
1	TR242414OMT	Coffee, 24D x 24W x 14H, Closed	1,272
Total List Price			2,674

GROUP 7 - SIDE NESTING, TRIPLE

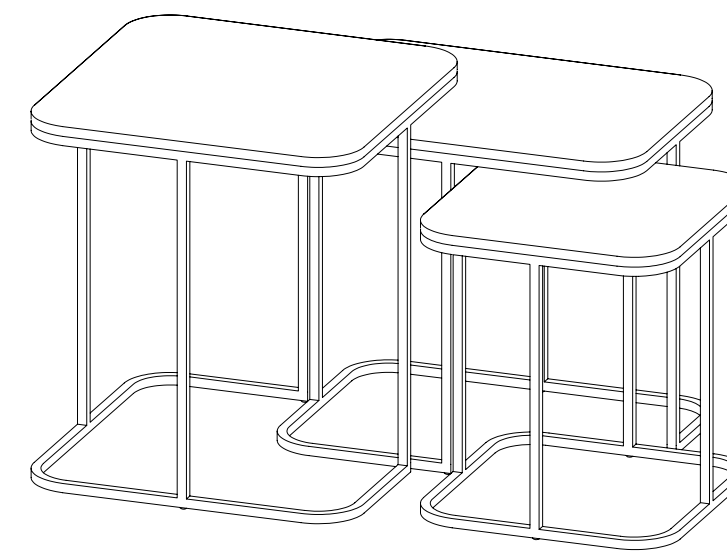

QTY	MODEL	DESCRIPTION	LIST
1	TR181820OMT	Side, 18D x 18W x 20H, Open	976
1	TR201418OMT	Side, 20D x 14W x 18H, Open	986
1	TR141416OMT	Side, 14D x 14W x 16H, Closed	873
Total List Price			2,835

GROUP 8 - COFFEE NESTING, TRIPLE

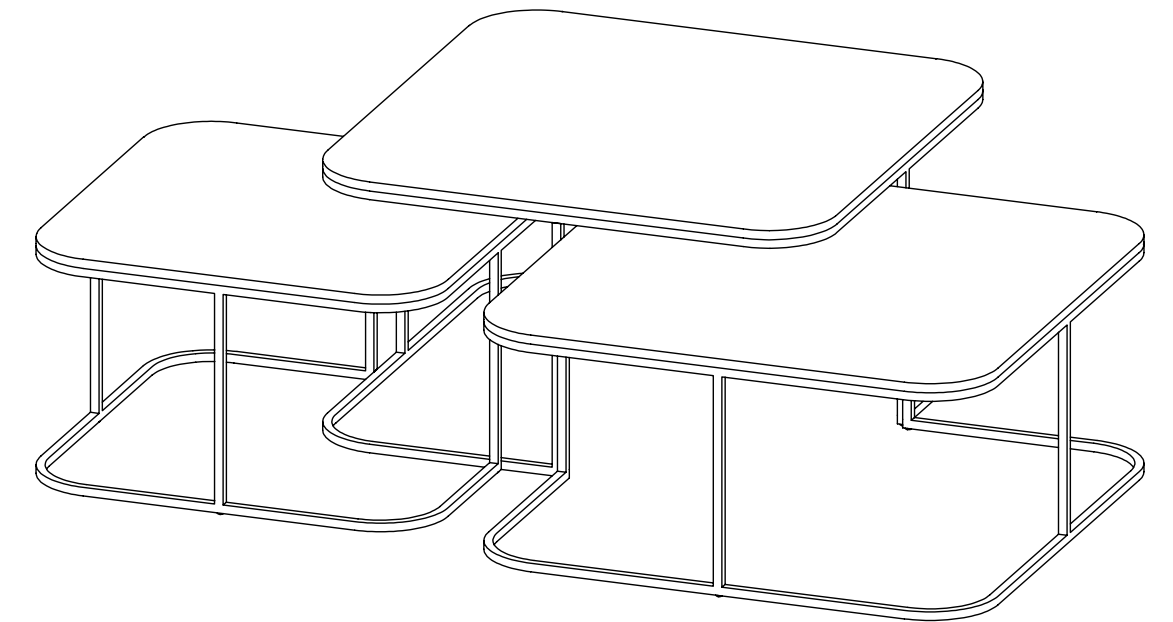

QTY	MODEL	DESCRIPTION	LIST
1	TR303016OMT	Coffee, 30D x 30W x 16H, Open	1,402
1	TR303014OMT	Coffee, 30D x 30W x 14H, Open	1,387
1	TR242414OMT	Coffee, 24D x 24W x 14H, Open	1,272
Total List Price			4,061

Trim

SPECIFICATION GUIDE: HOW TO ORDER

MODEL CODE BREAKDOWN

Sample Model Code: TR141416OSW81BM

1. Series

2. Model

3. Style

4. Top Material

5. Top Finish

6. Base Finish

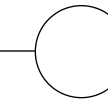
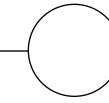
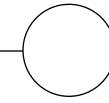
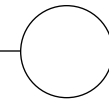
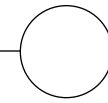
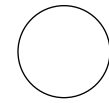

TR

141416

O

SW

81

BM

Series
TR TRIM

Model

141416	SIDE TABLE 14 W X 14 L X 16 H
141418	SIDE TABLE 14 W X 14 L X 18 H
181818	SIDE TABLE 18'W X 18"L X 18" H
181820	SIDE TABLE 18 W X 18 L X 20 H
201418	SIDE TABLE 20 W X 14 L X 18 H
201420	SIDE TABLE 20 W X 14 L X 20 H
2014245	LOUNGE PULL UP TABLE 20 W X 14 L X 24.5 H
2014265	TASK PULL UP TABLE 20 W X 14 L X 26.5 H
242412	COFFEE TABLE 24 W X 24 L X 12 H
242414	COFFEE TABLE 24 W X 24 L X 14 H
303014	COFFEE TABLE 30 W X 30 L X 14 H
303016	COFFEE TABLE 30 W X 30 L X 16 H
363616	COFFEE TABLE 36 W X 36 L X 16 H

Style
C CLOSED
O OPEN

Top Material

MT	METAL
SW	SOLID WOOD
CS	CAESARSTONE
SS	SOLID SURFACE
GB	BACK PAINTED GLASS
LMG1	LAMINATE GRADE 1
LMG2	LAMINATE GRADE 2

Laminate Grade 1

01	DESIGNER WHITE
02	ALABASTER
03	WALLABY
04	SHADOW
05	DOVE GRAY
06	FASHION GRAY
07	SLATE GRAY
08	NORTH SEA
09	BLACK
10	FUSION MAPLE
11	MONTICELLO MAPLE
12	RIVER CHERRY
13	AMBER CHERRY
14	WALNUT HEIGHTS
15	MONTANA WALNUT
16	XANADU
17	ASIAN NIGHT
18	CASTLE OAK

Laminate Grade 2

41	BIANCO KOS
42	GRIGIO EFESO
43	GRIGIO LONDRA
44	GRIGIO BROMO
45	NERO INGO

Solid Wood

81	WHITE OAK
85	WALNUT

Caesarstone

51	JET BLACK
52	SLEEK CONCRETE
65	PURE WHITE
96	STATUARIO NUVO

Solid Surface

01	ARCTIC WHITE
03	IVORY WHITE
04	GRAY
05	STEEL GRAY
06	BLACK

Back-Painted Glass

01	BLACK
02	WHITE

Standard Powder Coated Metal

BL	BLUE
BM	BLACK MATTE
CP	CHAMPAGNE
DB	DARK BRONZE
DG	DARK GRAY
DP	DUSTY PINK
DS	DARK SAGE
LG	LIGHT GRAY
LL	LILAC GRAY
LP	LIGHT PISTACHIO
LR	LIPSTICK RED
MB	MIDNIGHT BLUE
MG	MEADOW GREEN
MK	MILK
MS	METALLIC SILVER
NK	NICKEL
OC	OCHRE
PY	PALE YELLOW
RO	RED ORANGE
RR	RUSTY RED
SB	SOFT BLUE
SD	SAND
TC	TERRACOTTA
TP	TAUPE

Trim

SIDE TABLE: 14D X 14W X 16H

TITLE	SERIES	DEPTH	WIDTH	HEIGHT	STYLE	MAT		DIMENSIONS	PRICE
 Side Table, 14D x 14W x 16H, Closed	TR	14	14	16	C	MT	Metal	14D x 14W x 16H	873
						SW	Solid Wood		1,588
						CS	Caesarstone		1,891
						SS	Solid Surface		1,716
						GB	Back-Painted Glass		860
						LM	Laminate		1,177
 Side Table, 14D x 14W x 16H, Open	TR	14	14	16	O	MT	Metal	14D x 14W x 16H	873
						SW	Solid Wood		1,588
						CS	Caesarstone		1,891
						SS	Solid Surface		1,716
						GB	Back-Painted Glass		860
						LM	Laminate		1,177

To Order Select Below

1. Series/Model

○

●

TR141416

Trim
Side Table
14D x 14W x 16H

2. Style

○

● **Style**

C CLOSED

O OPEN

3. Top Material

○

● **Top Material**

MT METAL

SW SOLID WOOD

CS CAESARSTONE

SS SOLID SURFACE

GB BACK-PAINTED GLASS

LMG1 LAMINATE GRADE 1

LMG2 LAMINATE GRADE 2

4. Top Finish

○

● **Laminate Grade 1**

01 DESIGNER WHITE

02 ALABASTER

03 WALLABY

04 SHADOW

05 DOVE GRAY

06 FASHION GRAY

07 SLATE GRAY

08 NORTH SEA

09 BLACK

10 FUSION MAPLE

11 MONTICELLO MAPLE

12 RIVER CHERRY

13 AMBER CHERRY

14 WALNUT HEIGHTS

15 MONTANA WALNUT

16 XANADU

17 ASIAN NIGHT

18 CASTLE OAK

4. Top Finish

● **Laminate Grade 2 +70**

41 BIANCO KOS

42 GRIGIO EFESO

43 GRIGIO LONDRA

44 GRIGIO BROMO

45 NERO INGO

● **Solid Wood**

81 WHITE OAK

85 WALNUT **+146**

● **Caesarstone**

51 JET BLACK

52 SLEEK CONCRETE

65 PURE WHITE **+82**

96 STATUARIO NUOVO **+453**

5. Base Finish

○

● **Standard Powder Coated Metal**

01 ARCTIC WHITE

03 IVORY WHITE

04 GREY **+416**

05 STEEL GREY **+504**

06 BLACK **+43**

● **Back-Painted Glass**

01 BLACK

02 WHITE

5. Base Finish

● **Standard Powder Coated Metal**

BL BLUE

BM BLACK MATTE

CP CHAMPAGNE

DB DARK BRONZE

DG DARK GRAY

DP DUSTY PINK

DS DARK SAGE

LG LIGHT GRAY

LL LILAC GRAY

LP LIGHT PISTACHIO

LR LIPSTICK RED

MB MIDNIGHT BLUE

MG MEADOW GREEN

MK MILK

MS METALLIC SILVER

NK NICKEL

OC OCHRE

PY PALE YELLOW

RO RED ORANGE

RR RUSTY RED

SB SOFT BLUE

SD SAND

TC TERRACOTTA

TP TAUPE

Selected Base Finish is automatically applied to Metal Top choice.

Trim

SIDE TABLE: 14D X 14W X 18H

TITLE	SERIES	DEPTH	WIDTH	HEIGHT	STYLE	MAT		DIMENSIONS	PRICE
 Side Table, 14D x 14W x 18H, Closed	TR	14	14	18	C	MT	Metal	14D x 14W x 18H	886
						SW	Solid Wood		1,602
						CS	Caesarstone		1,899
						SS	Solid Surface		1,724
						GB	Back-Painted Glass		872
						LM	Laminate		1,186
 Side Table, 14D x 14W x 18H, Open	TR	14	14	18	O	MT	Metal	14D x 14W x 18H	886
						SW	Solid Wood		1,602
						CS	Caesarstone		1,899
						SS	Solid Surface		1,724
						GB	Back-Painted Glass		872
						LM	Laminate		1,186

To Order Select Below

1. Series/Model

TR141418

Trim
Side Table
14D x 14W x 18H

2. Style

C CLOSED
O OPEN

3. Top Material

MT METAL
SW SOLID WOOD
CS CAESARSTONE
SS SOLID SURFACE
GB BACK-PAINTED GLASS
LMG1 LAMINATE GRADE 1
LMG2 LAMINATE GRADE 2

4. Top Finish

Laminate Grade 1

01 DESIGNER WHITE
02 ALABASTER
03 WALLABY
04 SHADOW
05 DOVE GRAY
06 FASHION GRAY
07 SLATE GRAY
08 NORTH SEA
09 BLACK
10 FUSION MAPLE
11 MONTICELLO MAPLE
12 RIVER CHERRY
13 AMBER CHERRY
14 WALNUT HEIGHTS
15 MONTANA WALNUT
16 XANADU
17 ASIAN NIGHT
18 CASTLE OAK

Laminate Grade 2 +70

41 BIANCO KOS
42 GRIGIO EFESO
43 GRIGIO LONDRA
44 GRIGIO BROMO
45 NERO INGO

Solid Wood

81 WHITE OAK
85 WALNUT +146

Caesarstone

51 JET BLACK
52 SLEEK CONCRETE
65 PURE WHITE +82
96 STATUARIO NUOVO +453

5. Base Finish

Solid Surface

01 ARCTIC WHITE
03 IVORY WHITE
04 GREY +416
05 STEEL GREY +504
06 BLACK +43

Back-Painted Glass

01 BLACK
02 WHITE

Standard Powder Coated Metal

BL BLUE
BM BLACK MATTE
CP CHAMPAGNE
DB DARK BRONZE
DG DARK GRAY
DP DUSTY PINK
DS DARK SAGE
LG LIGHT GRAY
LL LILAC GRAY
LP LIGHT PISTACHIO
LR LIPSTICK RED
MB MIDNIGHT BLUE

MG MEADOW GREEN
MK MILK
MS METALLIC SILVER
NK NICKEL
OC OCHRE
PY PALE YELLOW
RO RED ORANGE
RR RUSTY RED
SB SOFT BLUE
SD SAND
TC TERRACOTTA
TP TAUPE

Selected Base Finish is automatically applied to Metal Top choice.

Trim

SIDE TABLE: 18D X 18W X 18H

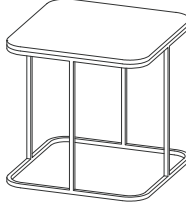
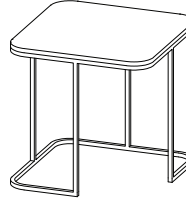
TITLE	SERIES	DEPTH	WIDTH	HEIGHT	STYLE	MAT		DIMENSIONS	PRICE
 Side Table, 18D x 18W x 18H, Closed	TR	18	18	18	C	MT	Metal	18D x 18W x 18H	959
						SW	Solid Wood		1,791
						CS	Caesarstone		2,877
						SS	Solid Surface		2,332
						GB	Back-Painted Glass		996
						LM	Laminate		1,267
 Side Table, 18D x 18W x 18H, Open	TR	18	18	18	O	MT	Metal	18D x 18W x 18H	959
						SW	Solid Wood		1,791
						CS	Caesarstone		2,877
						SS	Solid Surface		2,332
						GB	Back-Painted Glass		996
						LM	Laminate		1,267

To Order Select Below

1. Series/Model

○

●

TR181818

Trim
Side Table
18D x 18W x 18H

2. Style

○

● **Style**

C CLOSED

O OPEN

3. Top Material

○

● **Top Material**

MT METAL

SW SOLID WOOD

CS CAESARSTONE

SS SOLID SURFACE

GB BACK-PAINTED GLASS

LMG1 LAMINATE GRADE 1

LMG2 LAMINATE GRADE 2

4. Top Finish

○

● **Laminate Grade 1**

01 DESIGNER WHITE

02 ALABASTER

03 WALLABY

04 SHADOW

05 DOVE GRAY

06 FASHION GRAY

07 SLATE GRAY

08 NORTH SEA

09 BLACK

10 FUSION MAPLE

11 MONTICELLO MAPLE

12 RIVER CHERRY

13 AMBER CHERRY

14 WALNUT HEIGHTS

15 MONTANA WALNUT

16 XANADU

17 ASIAN NIGHT

18 CASTLE OAK

4. Top Finish

● **Laminate Grade 2 +70**

41 BIANCO KOS

42 GRIGIO EFESO

43 GRIGIO LONDRA

44 GRIGIO BROMO

45 NERO INGO

● **Solid Wood**

81 WHITE OAK

85 WALNUT **+239**

● **Caesarstone**

51 JET BLACK

52 SLEEK CONCRETE

65 PURE WHITE **+110**

96 STATUARIO NUOVO **+604**

5. Base Finish

○

● **Standard Powder Coated Metal**

01 ARCTIC WHITE

03 IVORY WHITE

04 GREY **+472**

05 STEEL GREY **+670**

06 BLACK **+96**

● **Back-Painted Glass**

01 BLACK

02 WHITE

5. Base Finish

● **Standard Powder Coated Metal**

BL BLUE

BM BLACK MATTE

CP CHAMPAGNE

DB DARK BRONZE

DG DARK GRAY

DP DUSTY PINK

DS DARK SAGE

LG LIGHT GRAY

LL LILAC GRAY

LP LIGHT PISTACHIO

LR LIPSTICK RED

MB MIDNIGHT BLUE

5. Base Finish

● **Standard Powder Coated Metal**

MG MEADOW GREEN

MK MILK

MS METALLIC SILVER

NK NICKEL

OC OCHRE

PY PALE YELLOW

RO RED ORANGE

RR RUSTY RED

SB SOFT BLUE

SD SAND

TC TERRACOTTA

TP TAUPE

Selected Base Finish is automatically applied to Metal Top choice.

Trim

SIDE TABLE: 18D X 18W X 20H

TITLE	SERIES	DEPTH	WIDTH	HEIGHT	STYLE	MAT		DIMENSIONS	PRICE
 Side Table, 18D x 18W x 20H, Closed	TR	18	18	20	C	MT	Metal	18D x 18W x 20H	976
						SW	Solid Wood		1,810
						CS	Caesarstone		2,886
						SS	Solid Surface		2,341
						GB	Back-Painted Glass		1,008
						LM	Laminate		1,276
 Side Table, 18D x 18W x 20H, Open	TR	18	18	20	O	MT	Metal	18D x 18W x 20H	976
						SW	Solid Wood		1,810
						CS	Caesarstone		2,886
						SS	Solid Surface		2,341
						GB	Back-Painted Glass		1,008
						LM	Laminate		1,276

To Order Select Below

1. Series/Model

○

●

TR181820

Trim
Side Table
18D x 18W x 20H

2. Style

○

● **Style**

C CLOSED

O OPEN

3. Top Material

○

● **Top Material**

MT METAL

SW SOLID WOOD

CS CAESARSTONE

SS SOLID SURFACE

GB BACK-PAINTED GLASS

LMG1 LAMINATE GRADE 1

LMG2 LAMINATE GRADE 2

4. Top Finish

○

● **Laminate Grade 1**

01 DESIGNER WHITE

02 ALABASTER

03 WALLABY

04 SHADOW

05 DOVE GRAY

06 FASHION GRAY

07 SLATE GRAY

08 NORTH SEA

09 BLACK

10 FUSION MAPLE

11 MONTICELLO MAPLE

12 RIVER CHERRY

13 AMBER CHERRY

14 WALNUT HEIGHTS

15 MONTANA WALNUT

16 XANADU

17 ASIAN NIGHT

18 CASTLE OAK

● **Laminate Grade 2** +70

41 BIANCO KOS

42 GRIGIO EFESO

43 GRIGIO LONDRA

44 GRIGIO BROMO

45 NERO INGO

● **Solid Wood**

81 WHITE OAK

85 WALNUT +239

● **Caesarstone**

51 JET BLACK

52 SLEEK CONCRETE

65 PURE WHITE +110

96 STATUARIO NUOVO +604

● **Solid Surface**

01 ARCTIC WHITE

03 IVORY WHITE

04 GREY +472

05 STEEL GREY +670

06 BLACK +96

● **Back-Painted Glass**

01 BLACK

02 WHITE

5. Base Finish

○

● **Standard Powder Coated Metal**

BL BLUE

BM BLACK MATTE

CP CHAMPAGNE

DB DARK BRONZE

DG DARK GRAY

DP DUSTY PINK

DS DARK SAGE

LG LIGHT GRAY

LL LILAC GRAY

LP LIGHT PISTACHIO

LR LIPSTICK RED

MB MIDNIGHT BLUE

MG MEADOW GREEN

MK MILK

MS METALLIC SILVER

NK NICKEL

OC OCHRE

PY PALE YELLOW

RO RED ORANGE

RR RUSTY RED

SB SOFT BLUE

SD SAND

TC TERRACOTTA

TP TAUPE

Selected Base Finish is automatically applied to Metal Top choice.

Trim

SIDE TABLE: 20D X 14W X 18H

TITLE	SERIES	DEPTH	WIDTH	HEIGHT	STYLE	MAT		DIMENSIONS	PRICE
 Side Table, 20D x 14W x 18H, Closed	TR	20	14	18	C	MT	Metal	20D x 14W x 18H	986
						SW	Solid Wood		1,780
						CS	Caesarstone		2,479
						SS	Solid Surface		2,378
						GB	Back-Painted Glass		978
						LM	Laminate		1,303
 Side Table, 20D x 14W x 18H, Open	TR	20	14	18	O	MT	Metal	20D x 14W x 18H	986
						SW	Solid Wood		1,780
						CS	Caesarstone		2,479
						SS	Solid Surface		2,378
						GB	Back-Painted Glass		978
						LM	Laminate		1,303

To Order Select Below

1. Series/Model

TR201418

Trim
Side Table
20D x 14W x 18H

2. Style

C CLOSED
O OPEN

3. Top Material

MT METAL
SW SOLID WOOD
CS CAESARSTONE
SS SOLID SURFACE
GB BACK-PAINTED GLASS
LMG1 LAMINATE GRADE 1
LMG2 LAMINATE GRADE 2

4. Top Finish

Laminate Grade 1

01 DESIGNER WHITE
02 ALABASTER
03 WALLABY
04 SHADOW
05 DOVE GRAY
06 FASHION GRAY
07 SLATE GRAY
08 NORTH SEA
09 BLACK
10 FUSION MAPLE
11 MONTICELLO MAPLE
12 RIVER CHERRY
13 AMBER CHERRY
14 WALNUT HEIGHTS
15 MONTANA WALNUT
16 XANADU
17 ASIAN NIGHT
18 CASTLE OAK

Laminate Grade 2 +165

41 BIANCO KOS
42 GRIGIO EFESO
43 GRIGIO LONDRA
44 GRIGIO BROMO
45 NERO INGO

Solid Wood

81 WHITE OAK
85 WALNUT +208

Caesarstone

51 JET BLACK
52 SLEEK CONCRETE
65 PURE WHITE +132
96 STATUARIO NUOVO +724

5. Base Finish

Solid Surface

01 ARCTIC WHITE
03 IVORY WHITE
04 GREY +332
05 STEEL GREY +186
06 BLACK +77

Back-Painted Glass

01 BLACK
02 WHITE

Standard Powder Coated Metal

BL BLUE
BM BLACK MATTE
CP CHAMPAGNE
DB DARK BRONZE
DG DARK GRAY
DP DUSTY PINK
DS DARK SAGE
LG LIGHT GRAY
LL LILAC GRAY
LP LIGHT PISTACHIO
LR LIPSTICK RED
MB MIDNIGHT BLUE

MG MEADOW GREEN
MK MILK
MS METALLIC SILVER
NK NICKEL
OC OCHRE
PY PALE YELLOW
RO RED ORANGE
RR RUSTY RED
SB SOFT BLUE
SD SAND
TC TERRACOTTA
TP TAUPE

Selected Base Finish is automatically applied to Metal Top choice.

Trim

SIDE TABLE: 20D X 14W X 20H

TITLE	SERIES	DEPTH	WIDTH	HEIGHT	STYLE	MAT		DIMENSIONS	PRICE
 Side Table, 20D x 14W x 20H, Closed	TR	20	14	20	C	MT	Metal	20D x 14W x 20H	995
						SW	Solid Wood		1,790
						CS	Caesarstone		2,486
						SS	Solid Surface		2,385
						GB	Back-Painted Glass		985
						LM	Laminate		1,310
 Side Table, 20D x 14W x 20H, Open	TR	20	14	20	O	MT	Metal	20D x 14W x 20H	995
						SW	Solid Wood		1,790
						CS	Caesarstone		2,486
						SS	Solid Surface		2,385
						GB	Back-Painted Glass		985
						LM	Laminate		1,310

To Order Select Below

1. Series/Model

○

●

TR201420

Trim
Side Table
20D x 14W x 20H

2. Style

○

● **Style**

C CLOSED

O OPEN

3. Top Material

○

● **Top Material**

MT METAL

SW SOLID WOOD

CS CAESARSTONE

SS SOLID SURFACE

GB BACK-PAINTED GLASS

LMG1 LAMINATE GRADE 1

LMG2 LAMINATE GRADE 2

4. Top Finish

○

● **Laminate Grade 1**

01 DESIGNER WHITE

02 ALABASTER

03 WALLABY

04 SHADOW

05 DOVE GRAY

06 FASHION GRAY

07 SLATE GRAY

08 NORTH SEA

09 BLACK

10 FUSION MAPLE

11 MONTICELLO MAPLE

12 RIVER CHERRY

13 AMBER CHERRY

14 WALNUT HEIGHTS

15 MONTANA WALNUT

16 XANADU

17 ASIAN NIGHT

18 CASTLE OAK

4. Top Finish

● **Laminate Grade 2** +165

41 BIANCO KOS

42 GRIGIO EFESO

43 GRIGIO LONDRA

44 GRIGIO BROMO

45 NERO INGO

● **Solid Wood**

81 WHITE OAK

85 WALNUT +208

● **Caesarstone**

51 JET BLACK

52 SLEEK CONCRETE

65 PURE WHITE +132

96 STATUARIO NUOVO +724

5. Base Finish

○

● **Standard Powder Coated Metal**

01 ARCTIC WHITE

03 IVORY WHITE

04 GREY +332

05 STEEL GREY +186

06 BLACK +77

● **Back-Painted Glass**

01 BLACK

02 WHITE

Selected Base Finish is automatically applied to Metal Top choice.

Trim

COFFEE TABLE: 24D X 24W X 12H

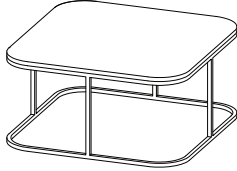
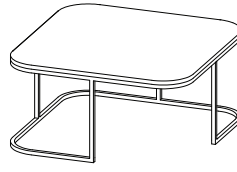
TITLE	SERIES	DEPTH	WIDTH	HEIGHT	STYLE	MAT		DIMENSIONS	PRICE
 Coffee Table, 24D x 24W x 12H, Closed	TR	24	24	12	C	MT	Metal	24D x 24W x 12H	1,260
						SW	Solid Wood		2,169
						CS	Caesarstone		3,346
						SS	Solid Surface		2,358
						GB	Back-Painted Glass		1,262
						LM	Laminate		1,438
 Coffee Table, 24D x 24W x 12H, Open	TR	24	24	12	O	MT	Metal	24D x 24W x 12H	1,260
						SW	Solid Wood		2,169
						CS	Caesarstone		3,346
						SS	Solid Surface		2,358
						GB	Back-Painted Glass		1,262
						LM	Laminate		1,438

To Order Select Below

1. Series/Model

TR242412

Trim
Coffee Table
24D x 24W x 12H

2. Style

C CLOSED
O OPEN

3. Top Material

MT METAL
SW SOLID WOOD
CS CAESARSTONE
SS SOLID SURFACE
GB BACK-PAINTED GLASS
LMG1 LAMINATE GRADE 1
LMG2 LAMINATE GRADE 2

4. Top Finish

Laminate Grade 1

01 DESIGNER WHITE
02 ALABASTER
03 WALLABY
04 SHADOW
05 DOVE GRAY
06 FASHION GRAY
07 SLATE GRAY
08 NORTH SEA
09 BLACK
10 FUSION MAPLE
11 MONTICELLO MAPLE
12 RIVER CHERRY
13 AMBER CHERRY
14 WALNUT HEIGHTS
15 MONTANA WALNUT
16 XANADU
17 ASIAN NIGHT
18 CASTLE OAK

Laminate Grade 2 +209

41 BIANCO KOS
42 GRIGIO EFESO
43 GRIGIO LONDRA
44 GRIGIO BROMO
45 NERO INGO

Solid Wood

81 WHITE OAK
85 WALNUT +428

Caesarstone

51 JET BLACK
52 SLEEK CONCRETE
65 PURE WHITE +198
96 STATUARIO NUOVO +1,087

5. Base Finish

Solid Surface

01 ARCTIC WHITE
03 IVORY WHITE
04 GREY +1,136
05 STEEL GREY +1,400
06 BLACK +129

Back-Painted Glass

01 BLACK
02 WHITE

Standard Powder Coated Metal

BL BLUE
BM BLACK MATTE
CP CHAMPAGNE
DB DARK BRONZE
DG DARK GRAY
DP DUSTY PINK
DS DARK SAGE
LG LIGHT GRAY
LL LILAC GRAY
LP LIGHT PISTACHIO
LR LIPSTICK RED
MB MIDNIGHT BLUE
MG MEADOW GREEN
MK MILK
MS METALLIC SILVER
NK NICKEL
OC OCHRE
PY PALE YELLOW
RO RED ORANGE
RR RUSTY RED
SB SOFT BLUE
SD SAND
TC TERRACOTTA
TP TAUPE

Selected Base Finish is automatically applied to Metal Top choice.

Trim

COFFEE TABLE: 24D X 24W X 14H

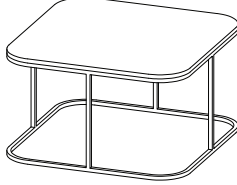
TITLE	SERIES	DEPTH	WIDTH	HEIGHT	STYLE	MAT		DIMENSIONS	PRICE
 Coffee Table, 24D x 24W x 14H, Closed	TR	24	24	14	C	MT	Metal	24D x 24W x 14H	1,272
						SW	Solid Wood		2,179
						CS	Caesarstone		3,351
						SS	Solid Surface		2,363
						GB	Back-Painted Glass		1,268
						LM	Laminate		1,444
 Coffee Table, 24D x 24W x 14H, Open	TR	24	24	14	O	MT	Metal	24D x 24W x 14H	1,272
						SW	Solid Wood		2,179
						CS	Caesarstone		3,351
						SS	Solid Surface		2,363
						GB	Back-Painted Glass		1,268
						LM	Laminate		1,444

To Order Select Below

1. Series/Model

TR242414

Trim
Coffee Table
24D x 24W x 14H

2. Style

C CLOSED
O OPEN

3. Top Material

MT METAL
SW SOLID WOOD
CS CAESARSTONE
SS SOLID SURFACE
GB BACK-PAINTED GLASS
LMG1 LAMINATE GRADE 1
LMG2 LAMINATE GRADE 2

4. Top Finish

Laminate Grade 1

01 DESIGNER WHITE
02 ALABASTER
03 WALLABY
04 SHADOW
05 DOVE GRAY
06 FASHION GRAY
07 SLATE GRAY
08 NORTH SEA
09 BLACK
10 FUSION MAPLE
11 MONTICELLO MAPLE
12 RIVER CHERRY
13 AMBER CHERRY
14 WALNUT HEIGHTS
15 MONTANA WALNUT
16 XANADU
17 ASIAN NIGHT
18 CASTLE OAK

Laminate Grade 2 +209

41 BIANCO KOS
42 GRIGIO EFESO
43 GRIGIO LONDRA
44 GRIGIO BROMO
45 NERO INGO

Solid Wood

81 WHITE OAK
85 WALNUT +428

Caesarstone

51 JET BLACK
52 SLEEK CONCRETE
65 PURE WHITE +198
96 STATUARIO NUOVO +1,087

5. Base Finish

Standard Powder Coated Metal

BL BLUE
BM BLACK MATTE
CP CHAMPAGNE
DB DARK BRONZE
DG DARK GRAY
DP DUSTY PINK
DS DARK SAGE
LG LIGHT GRAY
LL LILAC GRAY
LP LIGHT PISTACHIO
LR LIPSTICK RED
MB MIDNIGHT BLUE

MG MEADOW GREEN
MK MILK
MS METALLIC SILVER
NK NICKEL
OC OCHRE
PY PALE YELLOW
RO RED ORANGE
RR RUSTY RED
SB SOFT BLUE
SD SAND
TC TERRACOTTA
TP TAUPE

Selected Base Finish is automatically applied to Metal Top choice.

Trim

COFFEE TABLE: 30D X 30W X 14H

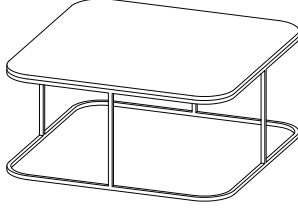
TITLE	SERIES	DEPTH	WIDTH	HEIGHT	STYLE	MAT		DIMENSIONS	PRICE
 Coffee Table, 30D x 30W x 14H, Closed	TR	30	30	14	C	MT	Metal	30D x 30W x 14H	1,387
						SW	Solid Wood		2,711
						CS	Caesarstone		4,363
						SS	Solid Surface		3,623
						GB	Back-Painted Glass		1,540
						LM	Laminate		1,653
 Coffee Table, 30D x 30W x 14H, Open	TR	30	30	14	O	MT	Metal	30D x 30W x 14H	1,387
						SW	Solid Wood		2,711
						CS	Caesarstone		4,363
						SS	Solid Surface		3,623
						GB	Back-Painted Glass		1,540
						LM	Laminate		1,653

To Order Select Below

1. Series/Model

TR303014

Trim
Coffee Table
30D x 30W x 14H

2. Style

C CLOSED
O OPEN

3. Top Material

MT METAL
SW SOLID WOOD
CS CAESARSTONE
SS SOLID SURFACE
GB BACK-PAINTED GLASS
LMG1 LAMINATE GRADE 1
LMG2 LAMINATE GRADE 2

4. Top Finish

Laminate Grade 1

01 DESIGNER WHITE
02 ALABASTER
03 WALLABY
04 SHADOW
05 DOVE GRAY
06 FASHION GRAY
07 SLATE GRAY
08 NORTH SEA
09 BLACK
10 FUSION MAPLE
11 MONTICELLO MAPLE
12 RIVER CHERRY
13 AMBER CHERRY
14 WALNUT HEIGHTS
15 MONTANA WALNUT
16 XANADU
17 ASIAN NIGHT
18 CASTLE OAK

Laminate Grade 2 +521

41 BIANCO KOS
42 GRIGIO EFESO
43 GRIGIO LONDRA
44 GRIGIO BROMO
45 NERO INGO

Solid Wood

81 WHITE OAK
85 WALNUT **+670**

Caesarstone

51 JET BLACK
52 SLEEK CONCRETE
65 PURE WHITE **+496**
96 STATUARIO NUOVO **+2,715**

5. Base Finish

Solid Surface

01 ARCTIC WHITE **+566**
03 IVORY WHITE **+566**
04 GREY **+828**
05 STEEL GREY **+1,223**
06 BLACK

Back-Painted Glass

01 BLACK
02 WHITE

Standard Powder Coated Metal

BL BLUE
BM BLACK MATTE
CP CHAMPAGNE
DB DARK BRONZE
DG DARK GRAY
DP DUSTY PINK
DS DARK SAGE
LG LIGHT GRAY
LL LILAC GRAY
LP LIGHT PISTACHIO
LR LIPSTICK RED
MB MIDNIGHT BLUE
MG MEADOW GREEN
MK MILK
MS METALLIC SILVER
NK NICKEL
OC OCHRE
PY PALE YELLOW
RO RED ORANGE
RR RUSTY RED
SB SOFT BLUE
SD SAND
TC TERRACOTTA
TP TAUPE

Selected Base Finish is automatically applied to Metal Top choice.

Trim

COFFEE TABLE: 30D X 30W X 16H

TITLE	SERIES	DEPTH	WIDTH	HEIGHT	STYLE	MAT		DIMENSIONS	PRICE
 <p>Coffee Table, 30D x 30W x 16H, Closed</p>	TR	30	30	16	C	MT	Metal	30D x 30W x 16H	1,402
						SW	Solid Wood		2,721
						CS	Caesarstone		4,369
						SS	Solid Surface		3,629
						GB	Back-Painted Glass		1,549
						LM	Laminate		1,658
 <p>Coffee Table, 30D x 30W x 16H, Open</p>	TR	30	30	16	O	MT	Metal	30D x 30W x 16H	1,402
						SW	Solid Wood		2,721
						CS	Caesarstone		4,369
						SS	Solid Surface		3,629
						GB	Back-Painted Glass		1,549
						LM	Laminate		1,658

To Order Select Below

1. Series/Model

TR303016

Trim
Coffee Table
30D x 30W x 16H

2. Style

C CLOSED
O OPEN

3. Top Material

MT METAL
SW SOLID WOOD
CS CAESARSTONE
SS SOLID SURFACE
GB BACK-PAINTED GLASS
LMG1 LAMINATE GRADE 1
LMG2 LAMINATE GRADE 2

4. Top Finish

Laminate Grade 1

01 DESIGNER WHITE
02 ALABASTER
03 WALLABY
04 SHADOW
05 DOVE GRAY
06 FASHION GRAY
07 SLATE GRAY
08 NORTH SEA
09 BLACK
10 FUSION MAPLE
11 MONTICELLO MAPLE
12 RIVER CHERRY
13 AMBER CHERRY
14 WALNUT HEIGHTS
15 MONTANA WALNUT
16 XANADU
17 ASIAN NIGHT
18 CASTLE OAK

Laminate Grade 2 +521

41 BIANCO KOS
42 GRIGIO EFESO
43 GRIGIO LONDRA
44 GRIGIO BROMO
45 NERO INGO

Solid Wood

81 WHITE OAK
85 WALNUT **+670**

Caesarstone

51 JET BLACK
52 SLEEK CONCRETE
65 PURE WHITE **+496**
96 STATUARIO NUOVO **+2,715**

5. Base Finish

Solid Surface

01 ARCTIC WHITE **+566**
03 IVORY WHITE **+566**
04 GREY **+828**
05 STEEL GREY **+1,223**
06 BLACK

Back-Painted Glass

01 BLACK
02 WHITE

Standard Powder Coated Metal

BL BLUE
BM BLACK MATTE
CP CHAMPAGNE
DB DARK BRONZE
DG DARK GRAY
DP DUSTY PINK
DS DARK SAGE
LG LIGHT GRAY
LL LILAC GRAY
LP LIGHT PISTACHIO
LR LIPSTICK RED
MB MIDNIGHT BLUE
MG MEADOW GREEN
MK MILK
MS METALLIC SILVER
NK NICKEL
OC OCHRE
PY PALE YELLOW
RO RED ORANGE
RR RUSTY RED
SB SOFT BLUE
SD SAND
TC TERRACOTTA
TP TAUPE

Selected Base Finish is automatically applied to Metal Top choice.

Trim

COFFEE TABLE: 36D X 36W X 16H

TITLE	SERIES	DEPTH	WIDTH	HEIGHT	STYLE	MAT		DIMENSIONS	PRICE
 <p>Coffee Table, 36D x 36W x 16H, Closed</p>	TR	36	36	16	C	MT	Metal	36D x 36W x 16H	1,669
						SW	Solid Wood		3,316
						CS	Caesarstone		5,635
						SS	Solid Surface		4,686
						GB	Back-Painted Glass		1,927
						LM	Laminate		1,868
 <p>Coffee Table, 36D x 36W x 16H, Open</p>	TR	36	36	16	O	MT	Metal	36D x 36W x 16H	1,669
						SW	Solid Wood		3,316
						CS	Caesarstone		5,635
						SS	Solid Surface		4,686
						GB	Back-Painted Glass		1,927
						LM	Laminate		1,868

To Order Select Below

1. Series/Model

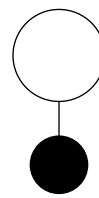

TR363616

Trim
Coffee Table
36D x 36W x 16H

2. Style

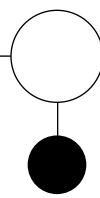

Style

C CLOSED
O OPEN

3. Top Material

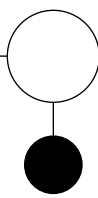

Top Material

MT METAL
SW SOLID WOOD
CS CAESARSTONE
SS SOLID SURFACE
GB BACK-PAINTED GLASS
LMG1 LAMINATE GRADE 1
LMG2 LAMINATE GRADE 2

4. Top Finish

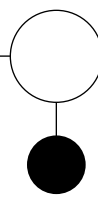

Laminate Grade 1

01 DESIGNER WHITE
02 ALABASTER
03 WALLABY
04 SHADOW
05 DOVE GRAY
06 FASHION GRAY
07 SLATE GRAY
08 NORTH SEA
09 BLACK
10 FUSION MAPLE
11 MONTICELLO MAPLE
12 RIVER CHERRY
13 AMBER CHERRY
14 WALNUT HEIGHTS
15 MONTANA WALNUT
16 XANADU
17 ASIAN NIGHT
18 CASTLE OAK

Laminate Grade 2 +471

41 BIANCO KOS
42 GRIGIO EFESO
43 GRIGIO LONDRA
44 GRIGIO BROMO
45 NERO INGO

Solid Wood

81 WHITE OAK
85 WALNUT **+964**

Caesarstone

51 JET BLACK
52 SLEEK CONCRETE
65 PURE WHITE **+661**
96 STATUARIO NUOVO **+3,621**

Solid Surface

01 ARCTIC WHITE
03 IVORY WHITE
04 GREY **+1,360**
05 STEEL GREY **+1,888**
06 BLACK **+257**

Back-Painted Glass

01 BLACK
02 WHITE

5. Base Finish

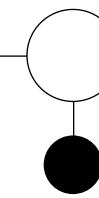

Standard Powder Coated Metal

BL BLUE
BM BLACK MATTE
CP CHAMPAGNE
DB DARK BRONZE
DG DARK GRAY
DP DUSTY PINK
DS DARK SAGE
LG LIGHT GRAY
LL LILAC GRAY
LP LIGHT PISTACHIO
LR LIPSTICK RED
MB MIDNIGHT BLUE
MG MEADOW GREEN
MK MILK
MS METALLIC SILVER
NK NICKEL
OC OCHRE
PY PALE YELLOW
RO RED ORANGE
RR RUSTY RED
SB SOFT BLUE
SD SAND
TC TERRACOTTA
TP TAUPE

Selected Base Finish is automatically applied to Metal Top choice.

Trim

PULL-UP TABLE: 20D X 14W X 24.5H

TITLE	SERIES	DEPTH	WIDTH	HEIGHT	STYLE	MAT		DIMENSIONS	PRICE
Pull-Up Table, 20D x 14W x 24.5H	TR	20	14	245	-	MT	Metal	20D x 14W x 24.5H	1,007
						SW	Solid Wood		1,798
						CS	Caesarstone		2,491
						SS	Solid Surface		2,390
						GB	Back-Painted Glass		991
						LM	Laminate		1,316

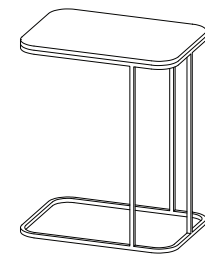

To Order Select Below

1. Series/Model

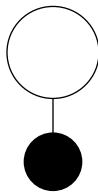

TR2014245

Trim
Pull-Up Table
20D x 14W x 24.5H

2. Top Material

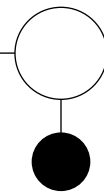

Top Material

MT	METAL
SW	SOLID WOOD
CS	CAESARSTONE
SS	SOLID SURFACE
GB	BACK-PAINTED GLASS
LMG1	LAMINATE GRADE 1
LMG2	LAMINATE GRADE 2

3. Top Finish

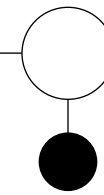

Laminate Grade 1

01	DESIGNER WHITE
02	ALABASTER
03	WALLABY
04	SHADOW
05	DOVE GRAY
06	FASHION GRAY
07	SLATE GRAY
08	NORTH SEA
09	BLACK
10	FUSION MAPLE
11	MONTICELLO MAPLE
12	RIVER CHERRY
13	AMBER CHERRY
14	WALNUT HEIGHTS
15	MONTANA WALNUT
16	XANADU
17	ASIAN NIGHT
18	CASTLE OAK

Laminate Grade 2 +165

41	BIANCO KOS
42	GRIGIO EFESO
43	GRIGIO LONDRA
44	GRIGIO BROMO
45	NERO INGO

Solid Wood

81	WHITE OAK
85	WALNUT +208

Caesarstone

51	JET BLACK
52	SLEEK CONCRETE
65	PURE WHITE +132
96	STATUARIO NUVO +724

Solid Surface

01	ARCTIC WHITE
03	IVORY WHITE
04	GREY +332
05	STEEL GREY +186
06	BLACK +77

Back-Painted Glass

01	BLACK
02	WHITE

4. Base Finish

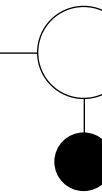

Standard Powder Coated Metal

BL	BLUE	MG	MEADOW GREEN
BM	BLACK MATTE	MK	MILK
CP	CHAMPAGNE	MS	METALLIC SILVER
DB	DARK BRONZE	NK	NICKEL
DG	DARK GRAY	OC	OCHRE
DP	DUSTY PINK	PY	PALE YELLOW
DS	DARK SAGE	RO	RED ORANGE
LG	LIGHT GRAY	RR	RUSTY RED
LL	LILAC GRAY	SB	SOFT BLUE
LP	LIGHT PISTACHIO	SD	SAND
LR	LIPSTICK RED	TC	TERRACOTTA
MB	MIDNIGHT BLUE	TP	TAUPE

Selected Base Finish is automatically applied to Metal Top choice.

Trim

PULL-UP TABLE: 20D X 14W X 26.5H

TITLE	SERIES	DEPTH	WIDTH	HEIGHT	STYLE	MAT		DIMENSIONS	PRICE
Pull-Up Table, 20D x 14W x 26.5H	TR	20	14	265	-	MT	Metal	20D x 14W x 26.5H	1,016
						SW	Solid Wood		1,806
						CS	Caesarstone		2,495
						SS	Solid Surface		2,395
						GB	Back-Painted Glass		1,000
						LM	Laminate		1,323

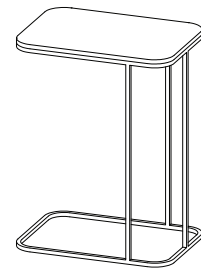

To Order Select Below

1. Series/Model

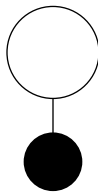

TR2014265

Trim
Pull-Up Table
20D x 14W x 26.5H

2. Top Material

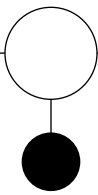

Top Material

MT	METAL
SW	SOLID WOOD
CS	CAESARSTONE
SS	SOLID SURFACE
GB	BACK-PAINTED GLASS
LMG1	LAMINATE GRADE 1
LMG2	LAMINATE GRADE 2

3. Top Finish

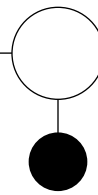

Laminate Grade 1

01	DESIGNER WHITE
02	ALABASTER
03	WALLABY
04	SHADOW
05	DOVE GRAY
06	FASHION GRAY
07	SLATE GRAY
08	NORTH SEA
09	BLACK
10	FUSION MAPLE
11	MONTICELLO MAPLE
12	RIVER CHERRY
13	AMBER CHERRY
14	WALNUT HEIGHTS
15	MONTANA WALNUT
16	XANADU
17	ASIAN NIGHT
18	CASTLE OAK

Laminate Grade 2 +165

41	BIANCO KOS
42	GRIGIO EFESO
43	GRIGIO LONDRA
44	GRIGIO BROMO
45	NERO INGO

Solid Wood

81	WHITE OAK
85	WALNUT +208

Caesarstone

51	JET BLACK
52	SLEEK CONCRETE
65	PURE WHITE +132
96	STATUARIO NUVO +724

Solid Surface

01	ARCTIC WHITE
03	IVORY WHITE
04	GREY +332
05	STEEL GREY +186
06	BLACK +77

Back-Painted Glass

01	BLACK
02	WHITE

4. Base Finish

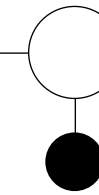

Standard Powder Coated Metal

BL	BLUE	MG	MEADOW GREEN
BM	BLACK MATTE	MK	MILK
CP	CHAMPAGNE	MS	METALLIC SILVER
DB	DARK BRONZE	NK	NICKEL
DG	DARK GRAY	OC	OCHRE
DP	DUSTY PINK	PY	PALE YELLOW
DS	DARK SAGE	RO	RED ORANGE
LG	LIGHT GRAY	RR	RUSTY RED
LL	LILAC GRAY	SB	SOFT BLUE
LP	LIGHT PISTACHIO	SD	SAND
LR	LIPSTICK RED	TC	TERRACOTTA
MB	MIDNIGHT BLUE	TP	TAUPE

Selected Base Finish is automatically applied to Metal Top choice.