

**stylex**

# **Luna**

**PRICE LIST**

Effective November 01, 2024

Updated November 06, 2024

# General Information

## STYLEX PRICE LIST

### GENERAL INFORMATION

#### Terms

Net 30 days from date of invoice,  
F. O. B . Delanco, New Jersey.

#### Damaged Shipments

All Stylex products are carefully inspected before they are packed in sturdy cartons designed to satisfy shipping requirements. Stylex is not responsible for damage in shipment. The transportation company assumes responsibility for delivering products to you in good condition when the bill of lading is signed. You protect yourself by refusing shipments showing damage or shortage until transportation company has noted on the delivery sheet the extent of damage or shortage. Concealed damage should be reported to the carrier as soon as discovered, but no later than 5 days after receiving shipment.

#### Return/Restocking Policy

Return shipments will not be accepted unless specifically authorized by Stylex in writing. The Return Authorization number should be clearly marked on the carton. The customer returning Stylex products is responsible for return shipping costs. Merchandise must be returned unused. Returned merchandise is subject to a 35% restocking fee.

#### Special Products

Modifications to standard products will be considered for large runs. Contact factory for price quotations.

#### Design Changes

In keeping with modern manufacturing advances, Stylex reserves the right to incorporate minor modifications and design changes in products without notice.

#### Cancellation/Change Order Policy

Regarding requests for order cancellation and/or order modification, please be advised that no charges will be applied before production, unless inventory has been specifically requisitioned to fulfill your order. Once orders proceed to the production phase, they cannot be altered or canceled under any circumstances. All requests for order cancellations or order changes must be submitted in writing and will only be considered valid upon approval by Stylex.

### WARRANTY

Except as provided below, Stylex warrants exclusively to the original Purchaser of our product that all parts, under normal use and service, will be free from defects in workmanship and material for a period of ten (10) years from the date of purchase. "Normal use and service" means that the product will be used in a typical office environment for 40-45 hours per week.

This warranty is subject to the following limitations, exclusions and provisions:

Limitations involving materials and components:

**Wood components of plywood stacking chairs**  
(such as Brooks and Welcome)  
5 years

#### Upholstery

(including mesh used for Click, F4, Insight, and Zephyr Mesh)  
3 years

#### SAVA Mesh

10 years

#### Pneumatic Cylinders

3 years

#### COM Upholstery

No warranty  
Stylex makes every effort to ensure that the COM Upholstery it approves is suitable for the intended use. Nevertheless, we will not warrant, and assume no responsibility for, the durability or tailoring quality of any COM or COL . If you have any concerns about the ultimate appearance of any covering, please order an upholstered sample.

#### Painted Stack Chair Frames

No Warranty  
We will not warrant the finish of painted stack chair frames against damage from stacking. Please order chrome frames for chairs that will be stacked.

#### Felt Glides

No warranty  
Due to the different surfaces on which felt glides may be used, we cannot warrant their durability over time.

If this product fails during normal use and service within the applicable warranty period (other than through normal wear and tear), please submit a warranty claim at [stylexdesign.com/warranty-claim/](http://stylexdesign.com/warranty-claim/). Quantity, model details, description of issue, and Stylex certified labels are required for submission. PLEASE DO NOT RETURN PARTS OR THE PRODUCT TO STYLEX UNLESS INSTRUCTED TO DO SO BY STYLEX. Stylex will, at its discretion, either repair or replace the defective product or part at no cost. Labor requests must receive approval and will be authorized on a case-by-case basis. We will only reimburse for labor costs directly incurred, excluding any travel-related expenses. Purchaser may be required (at the option of Stylex) to return to Stylex at Purchaser's expense any defective part with all freight or shipping charges prepaid. The foregoing warranty shall be void if the product has been altered or repaired (other than by Stylex). The warranty does not cover damage to the product caused by accident, neglect, misuse, abuse, modification to the product by anyone other than Stylex or damage caused by use of the product for a purpose other than that for which it was designed. This warranty extends only to the original Purchaser of the product.

#### No Other Warranties

This warranty is in lieu of all other warranties, expressed or implied, including, but not limited to, implied warranties of merchantability and fitness for a particular purpose. The rights and remedies provided herein are the exclusive rights and remedies of the original purchaser of the product.

#### No Liability For Damages

In no event shall Stylex or its suppliers be responsible or liable for any special, indirect, consequential, or incidental damages. In no event shall the liability of Stylex exceed the actual purchase price paid to Stylex for the product.

#### Out of Warranty Products

For all products no longer covered by our warranty, please refer to our Design for Durability and Upgradability Policy. Contact your Account Manager if you would like to purchase any replaceable components to further extend the life of any Stylex seating product. This warranty applies to all Stylex products purchased on April 13, 2018, and thereafter.

### PRODUCT TAKE BACK PROGRAM

In order to be good stewards of our products, Stylex offers a pathway towards a Product Take Back Program as a more viable solution to the end of our products' originally intended life.

Stylex supports the sustainable programs of ANEW and offers their added value to our clients through a comprehensive take-back solution for surplus office furniture and materials of any kind, in any condition. ANEW is a 501(c)(3) non-profit organization that exists to provide companies with smart, cost effective alternatives for their surplus furniture and other items with the priority of matching it to non- profits, public agencies and the underserved, within the local community of the project site. Corporate Social Responsibility is raised while the impact on the environment is lowered by diverting products and materials otherwise destined for landfill.

Stylex is proud to offer ANEW to customers dedicated to strengthening their community network by repurposing their furniture, fixtures and architectural materials to those in need. In 2014, Stylex committed to making this relationship a part of our strategic sales strategy. Visit [www.anewfound.org](http://www.anewfound.org) to find out more.

To initiate a Product Take Back strategy through ANEW, contact Stylex Account Management at 800-257-5742.

For other end of life recovery options, please see our Product Disassembly Instructions and End of Life Recovery Options documents available on our website in the resources section of each product in our line.

### FREIGHT PROGRAM

Freight charges will be calculated as a percentage of the net product price and added to the invoice at the time of shipment. The continental United States has been divided into three zones. Please use the map below to determine freight charges for the product's destination. Minimum freight charge is \$250. Please let us know if you will be shipping to a residential address or require inside delivery as this requires an additional fee. Also please note we need to be made aware if a liftgate is required prior to delivery. If any requests are made at the time of delivery, applicable charges will apply.

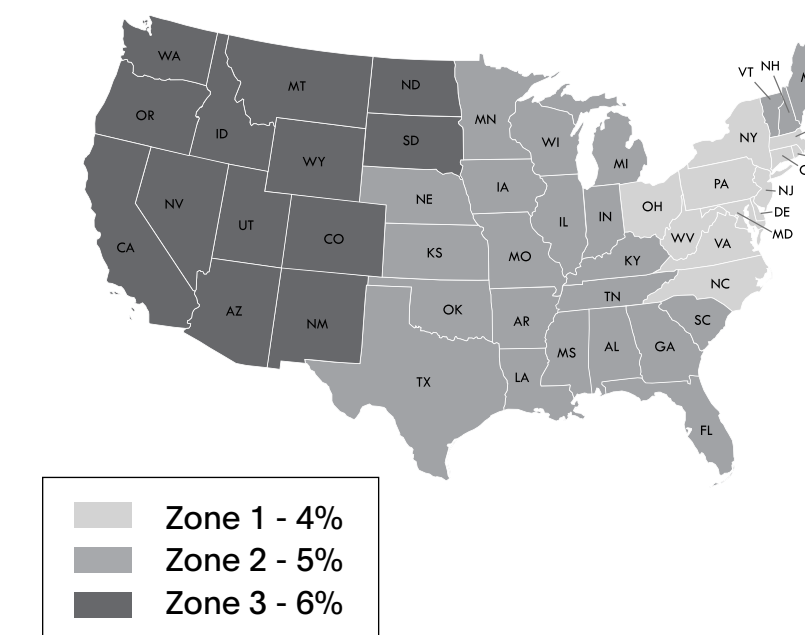

### ZONE 1 - 4%

Connecticut  
Delaware  
New York  
New Jersey  
Maryland  
Massachusetts  
North Carolina  
Ohio  
Pennsylvania  
Rhode Island  
Virginia  
Washington D.C.  
West Virginia

### ZONE 2 - 5%

Alabama  
Arkansas  
Canada, Ontario  
Canada, Quebec  
Florida  
Georgia  
Iowa  
Illinois  
Indiana  
Kansas  
Kentucky  
Louisiana  
Nebraska  
New Hampshire  
Oklahoma  
Maine  
Michigan  
Minnesota  
Missouri  
Mississippi  
South Carolina  
Tennessee  
Texas  
Vermont  
Wisconsin

### ZONE 3 - 6%

Arizona  
California  
Colorado  
Idaho  
Montana  
Nevada  
New Mexico  
North Dakota  
Oregon  
South Dakota  
Utah  
Washington  
Wyoming

**Quote Per Project**  
Alaska  
Hawaii  
Canada  
(outside Ontario & Quebec)  
Mexico

# General Information

## STYLEX PRICE LIST

### TEXTILE PARTNERS & APPROVALS

#### Textile Partners

To customize your furniture performance needs and design vision, Stylex offers a wide selection of in-graded leathers and textiles from Grades A through Y. We've partnered with leading manufacturers on the options, focusing on color, price, durability, and construction. To view our partners and explore our digital carded program with broadly approved textiles, visit [this page](#). We stand by these textiles: They're tried and tested, and will effortlessly fit into any design aesthetic.

#### Textile Approvals

All textiles must be approved for the product you are specifying. For the related approved textile lists, visit [this page](#).

### CAL 117 AND 133 COMPLIANCE

#### CAL 117-2013

CAL 117-2013 compliance is a requirement for all textiles applied on our seating products. All Stylex seating products meet this standard.

#### CAL 133

Most Stylex seating can be ordered to meet the requirements of CAL 133. When ordering, simply specify "CAL 133 compliance required". The upcharge for this option is \$54 list per yard. Please refer to the COM yardage of each model to determine the number of yards required. We do frequently require full-scale burn tests in order to certify CAL 133 before an order will be accepted. Such burn tests may increase normal lead times and do carry additional charges. Please contact your Stylex account manager for details.

### CUSTOMER'S OWN MATERIAL/LEATHER

Customer's own material (COM) and customer's own leather (COL) will generally be upholstered at the price designated in each product's price list. Please be advised, however, that we specifically reserve the right to charge a higher price when we determine that special circumstances, such as unusual repeats or challenging materials, present themselves. All orders for custom coverings must be approved by Stylex before they will be accepted for production. To submit proposed textile for approval, please use the COM form [here](#).

#### Special Note:

We assume no responsibility for the durability or tailoring quality of any COM or COL. Directional covers in particular may not meet your satisfaction due to the design of certain products. Please be advised that COM and COL orders are not subject to return. If you have doubts about the ultimate appearance of certain coverings, please order a sample done with that specific COM or COL. In addition, while we inspect fabrics for mill imperfections, some are difficult to recognize. We cannot be responsible for defects, color inaccuracies, dye lot variations, or other flaws.

Under no circumstances will we be responsible for COM shortages, flaws, or other such problems. Finally, it is not our responsibility to police the receipt of COM's in order to meet delivery deadlines, and we assume our customers are aware of any undue delay in the shipment of their COM fabrics.

#### COM fabric and COL leather should be sent prepaid to: Stylex

**Attn: COM/COL - [Your Stylex PO #]  
740 Coopertown Road  
Delanco, NJ 08075**

**All COM/COL sent to Stylex must be accompanied with a packing list which indicates the dealers' name, Stylex corresponding PO number, sales order number, COM/COL supplier name, textile pattern, colorway and shipped quantity. Stylex requires COM to be sent in as continuous yardage in the same dielot.**

Yardage requirements shown in the price list are based on non-directional goods of 54" width. Fabrics less than 54" wide or those requiring matching (stripes, prints, or large patterned designs) call for additional yardage. We will be happy to supply yardage requirements for large quantities where economies may be realized.

#### Add the following yardage for stripes, plaids, or patterns with repeats:

Fabric Width	Plain Fabric	2-14" Repeat	15-24" Repeat	25-27" Repeat	28-36" Repeat
54"	0%	10%	15%	20%	25%
50"	10%	20%	25%	30%	35%
48"	15%	25%	30%	35%	40%
45"	40%	50%	55%	60%	65%
36"	50%	60%	65%	70%	75%

### COM/COL FORM

To avoid delay in processing COM orders we request that you submit a sample of your COM textile stapled to this form which can be downloaded [here](#). If a textile has a stripe or design, the size of the repeat should be indicated. Please indicate the textile supplier's name, textile number, and color. Also indicate the Stylex product on which the textile will be used. If a certain direction of application is required, please ensure that information is communicated directly to your Stylex account manager.

The fabric supplier must indicate on his shipping labels the dealer name and purchase order number as well as the Stylex model number.

#### Please Note:

No order may be entered into production or have a shipping date assigned until all related COM is received at the factory.



### CENTER OF STRIPE OR DESIGN

TOP OF CHAIR	TOP OF CHAIR
--------------	--------------

1. Size of Repeat

2. Textile Supplier

3. Textile Number

4. Color

5. Stylex Product

# Luna

# Contents

ABOUT	5	SEATING: ELEVATED	17
STATEMENT OF LINE	6	SEATING: PLINTH	25
PRODUCT INFORMATION	10	TRAY TABLE	33
DIMENSIONS	11	TABLET ARM	34
HOW TO ORDER	13	PLANTER	36
COLORS, MATERIALS, AND FINISHES	16		

CLICK THE TITLES ABOVE TO NAVIGATE THROUGH THE DOCUMENT  
PRODUCT HEADERS ON SUBSEQUENT PAGES LINK BACK TO THIS PAGE

# Luna

ABOUT

Introducing Luna, banquette seating that offers precise customization down to the inch, ensuring a perfect fit even in the most unconventional spaces. With segments ranging from 25" to 60", Luna allows you to create symmetrical and tailored seating arrangements, whether running or stand alone, with the option for half-moon-shaped arms. Luna seamlessly integrates with our Still screens, and the collection includes options for high or low backs, a planter for enclosed layouts, and a trio of accessory tables. Pricing is offered in seven different buckets, conveniently divided into 5" increments, ensuring efficiency and ease in specification. For layout assistance, our Design Application team is at your service – get in touch at [designapplication@stylexdesign.com](mailto:designapplication@stylexdesign.com).



ELEVATED, LOW BACK



PLINTH, HIGH BACK, PLANTERS

# Luna

## SPECIFICATION GUIDE: STATEMENT OF LINE, ELEVATED SEATING

### OVERVIEW

<b>Elevated Low Back</b>	Standard	Arm Left	Arm Right	Arm Both	Armless End Left	Armless End Right
	Round Inside Corner	Square Inside Corner	Round Outside Corner	Round End Cap		
<b>Elevated High Back</b>	Standard	Arm Left	Arm Right	Arm Both	Armless End Left	Armless End Right
	Round Inside Corner	Square Inside Corner	Round Outside Corner	Round End Cap		

### PRODUCT INFORMATION

#### Design

A Stylex Design, by Anthony Land

#### Legs (Elevated)

Elevated units come with cast aluminum legs, available in a polished finish and Stylex's standard powder coat colors. They can also be ordered without legs for custom millwork.

#### Configuration

Luna can be ordered as freestanding units or as part of a larger layout. When ordering, it's crucial to specify whether each line item is freestanding or for the start/mid/end of a layout. Arrange them from left to right as viewed from a seated perspective. We highly recommend using CET Designer for specifying this product for optimal accuracy.

#### Use

Designed for indoor use only.

#### Performance Standards

Manufactured to comply with:  
ANSI/BIFMA X5.4 Lounge Seating Tests

#### Certifications

GREENGUARD Gold  
BIFMA LEVEL® 2 Certified

# Luna

## SPECIFICATION GUIDE: STATEMENT OF LINE, PLINTH SEATING

OVERVIEW						
<b>Plinth Low Back</b>	Standard	Arm Left	Arm Right	Arm Both	Armless End Left	Armless End Right
	Round Inside Corner	Square Inside Corner	Round Outside Corner	Round End Cap		
<b>Plinth High Back</b>	Standard	Arm Left	Arm Right	Arm Both	Armless End Left	Armless End Right
	Round Inside Corner	Square Inside Corner	Round Outside Corner	Round End Cap		

### PRODUCT INFORMATION

#### Design

A Stylex Design, by Anthony Land

#### Toe Kick (Plinth)

Plinth units include a 2.625" black laminate toe kick.

#### Configuration

Luna can be ordered as freestanding units or as part of a larger layout. When ordering, it's crucial to specify whether each line item is freestanding or for the start/mid/end of a layout. Arrange them from left to right as viewed from a seated perspective. We highly recommend using CET Designer for specifying this product for optimal accuracy.

#### Use

Designed for indoor use only.

#### Performance Standards

Manufactured to comply with:  
ANSI/BIFMA X5.4 Lounge Seating Tests

#### Certifications

GREENGUARD Gold  
BIFMA LEVEL® 2 Certified

# Luna

## SPECIFICATION GUIDE: STATEMENT OF LINE, PLANTERS, TRAYS AND TABLET ARMS

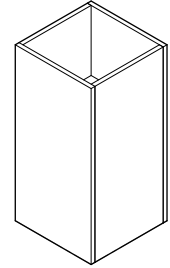
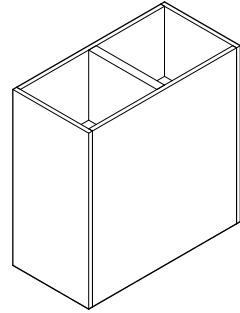
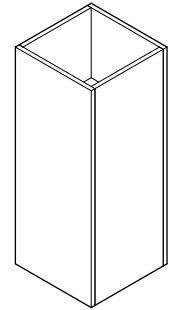
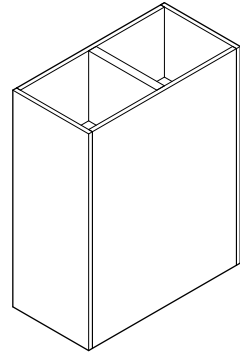
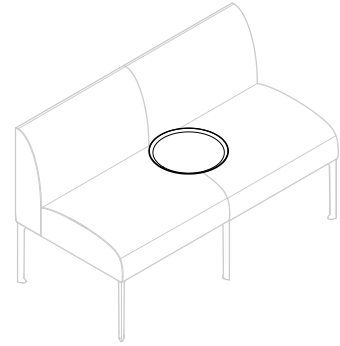
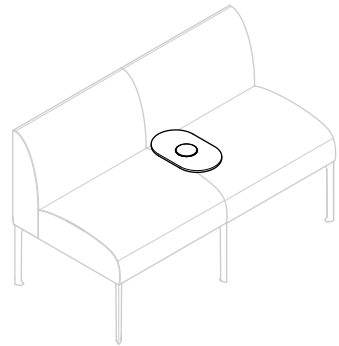
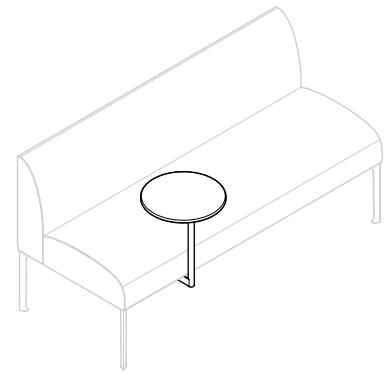
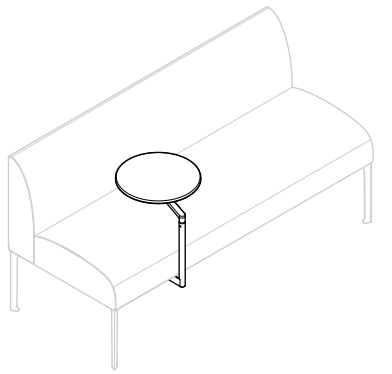
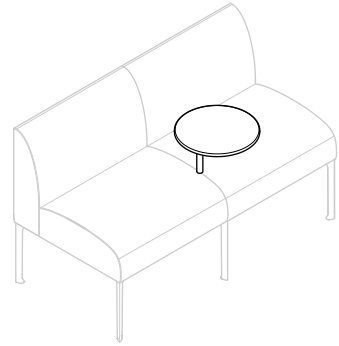
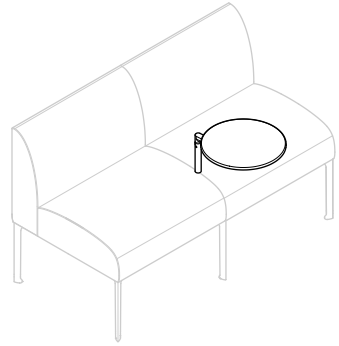
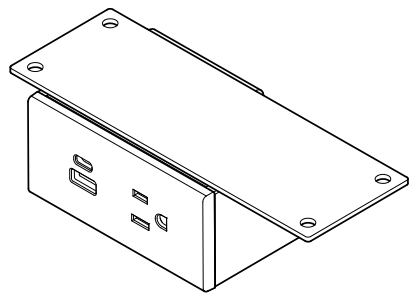
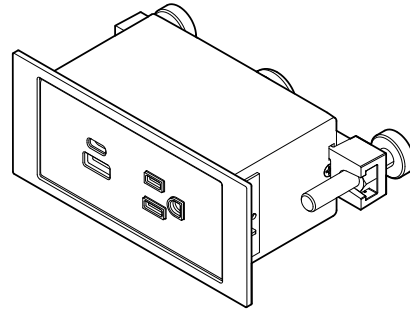
OVERVIEW						
<b>Planter Low Back Height</b>	Single 	Double 				
<b>Planter High Back Height</b>	Single 	Double 				
<b>Tray &amp; Tablet Arm</b>	Round Tray Table 	Wireless Charging Tray 	Under Mount, Single Swivel 	Under Mount, Dual Swivel 	Seat Mount, Single Swivel 	Seat Mount, Dual Swivel 
<b>Power</b>	Under Mount (for Elevated style) 	Flush Mount (for Plinth style) 				

## PRODUCT INFORMATION

### Planters

Planters extend to the floor, resting on height-adjustable glides, and feature a black laminate finish over an MDF core. They are concealed on all vertical sides by seat units or a wall. Please note that enclosed planters are not intended to be exposed; they should be surrounded by seating units or placed against a wall. Exposed planters can be exposed on all sides.

### Tray Tables and Tablet Arms

The round tray table is made of steel and available in 26 powder coat finishes.

The wireless charging tray comes in four different solid wood finish options, featuring a black wireless surface mount charging unit in the center of the oval top.

Tablet arms are available in single or dual swivel, with four solid wood finish options.

### Power

Elevated units offer undermount power beneath the seats, while plinth units offer flush mount power in the front. You can specify power units to be hardwired or equipped with a 3-prong plug. These units feature one USB-A port, one USB-C port, and a standard grounded 3-prong electrical outlet. Default cord lengths are 10 feet, with custom lengths available. Additional power options include daisy chain and wireless surface mount charging. Power units come with wire management clips for every 1-foot length of cord. Daisy chain infeeds are offered in 5', 10', and 15' standard lengths with a 3-prong plug.

### Use

Designed for indoor use only.

### Performance Standards

Manufactured to comply with:  
ANSI/BIFMA X5.4 Lounge Seating Tests





### Certifications

GREENGUARD Gold  
BIFMA LEVEL® 2 Certified

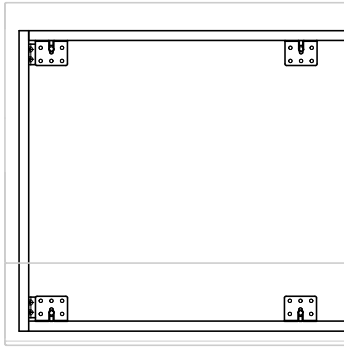
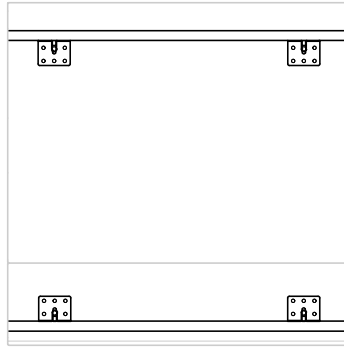
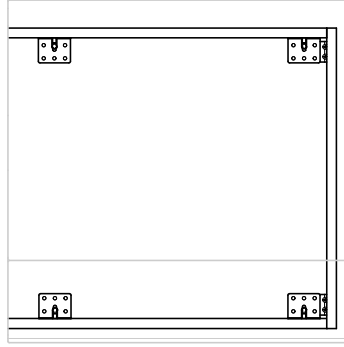
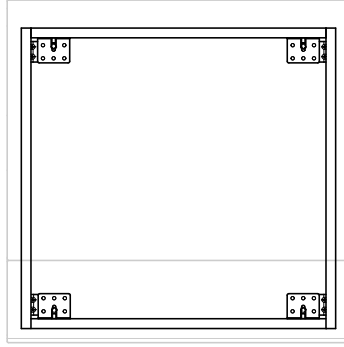
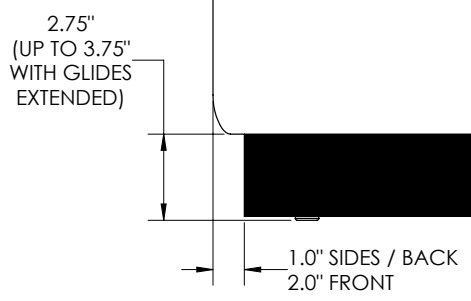
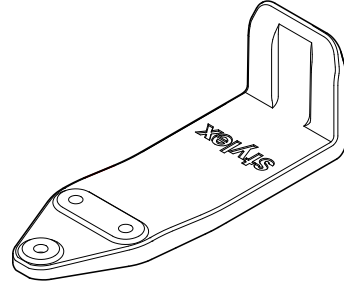
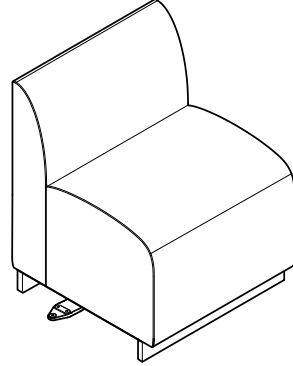
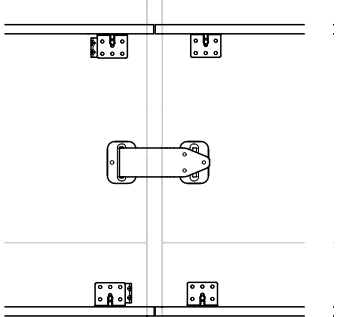
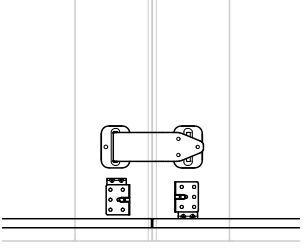
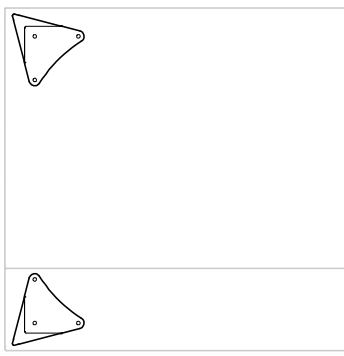
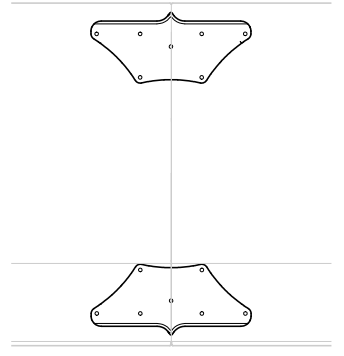
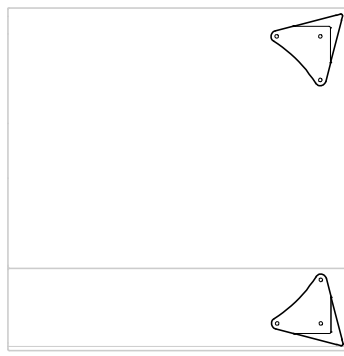
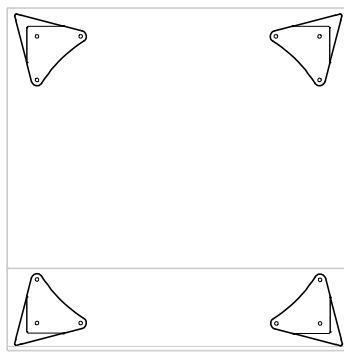
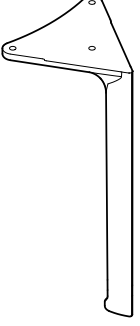
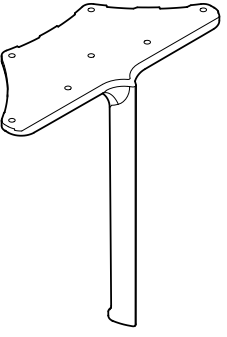

# Luna

## SPECIFICATION GUIDE: ACCESSORIES AND DETAILS

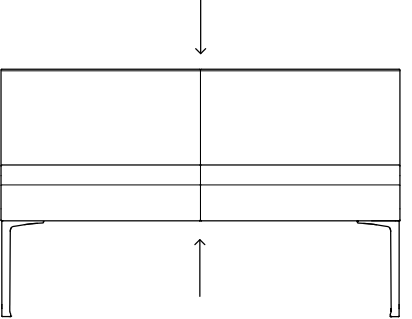
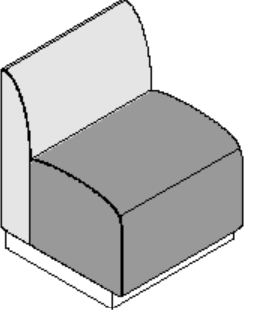
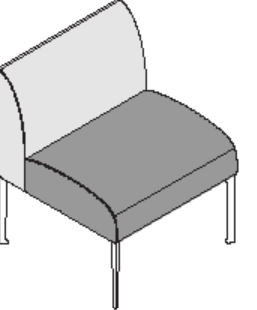
OVERVIEW						
<b>Plinth Position</b>	Start 	Mid 	End 	Freestanding 		Plinth Inset 
<b>Plinth Ganging</b>	Ganging Bracket 		Side-to-Side 	Back-to-Back 		
<b>Elevated Leg Position</b>	Start 	Mid 	End 	Freestanding 	Start, End Leg Elevated 	Mid Leg Elevated 
<b>Upholstery Details</b>	Standard 	Armless End 	Arm 	Mid Seam (for units 46" and larger) 	Dual Fabric for Plinth Textile 1 - Seat Textile 2 - Back 	Dual Fabric for Elevated Textile 1 - Seat Textile 2 - Back 

### PRODUCT INFORMATION

#### Plinth

The plinth is designed to provide a continuous appearance at the front, back, and exposed ends of a unit. However, the plinth side panels are removed when ordered as the Start, Mid, and End of a ganged layout.

#### Ganging

Elevated style units employ mid legs for ganging seating units side-to-side and back-to-back, while plinth style units use ganging brackets to connect seats in the same manner. Plinth Start, Mid, and End units can be ganged side-to-side and come with cast aluminum drop-on ganging brackets for tool-free assembly.

#### Elevated - Legs

Elevated seats share a leg between non-standalone units, while standalone units have four legs. The legs for elevated units are installed in the field.

#### Glides

All units come standard with adjustable glides, allowing for 3/4" adjustment.

#### Upholstery Details

- Standard units feature a top-edge seam and are designed to be flush side to side.
- Armless End and Arm units have a roll-style seam at the exposed end of a layout.
- Units 46" and larger include a middle seam.
- Luna offers a dual upholstery option.

#### Use

Designed for indoor use only.

#### Performance Standards

Manufactured to comply with:  
ANSI/BIFMA X5.4 Lounge Seating Tests

#### Certifications

GREENGUARD Gold  
BIFMA LEVEL® 2 Certified

# Luna

## SPECIFICATION GUIDE: PRODUCT INFORMATION, POWER

OVERVIEW	POSITION 2 (RIGHT)	POSITION 1 AND 2 (LEFT AND RIGHT)	POSITION 1 (LEFT)
<b>Elevated</b>			
<b>Plinth Standard</b>			
<b>Plinth with Arm(s) (Arm Right Shown)</b>			
<b>Plinth Armless (Armless Right Shown)</b>			

### PRODUCT INFORMATION

#### Power

Elevated units offer undermount power beneath the seats, while plinth units offer flush mount power in the front. You can specify power units to be hardwired or equipped with a 3-prong plug. These units feature one USB-A port, one USB-C port, and a standard grounded 3-prong electrical outlet. Default cord lengths are 10 feet, with custom lengths available. Additional power options include daisy chain and wireless surface mount charging. Power units come with wire management clips for every 1-foot length of cord. Daisy chain infeeds are offered in 5', 10', and 15' standard lengths with a 3-prong plug.

#### Mounting Options

Under mount power is designated by (U) in the model code. Flush mount power is designated by (F) in the model code.

#### Cord Length

Both the standard cord and the conduit whip are 10ft long. Other lengths are available as a custom order.

#### Colors

Under mount power units are offered in black (B), gray (G), and white (W), while flush mount power units are available in black (B) and gray (G).

#### Cable Management

All elevated units include cable mounts and screws for assembly and installation. Power units come with wire management clips for every 1-foot length of cord.

For plinth units against a wall, the rear-side toe kick can be removed to allow for cord egress.

For plinth units not against a wall, the unit may be raised up by extending the glides or the installer may cut a small mouse hole in the toe kick. See assembly instructions for more information.

#### Location

On elevated units, the power is located under the front edge, next to the leg. For plinth units, the power is flush to the front, positioned 8" on center from the side of the unit. However, for arm and armless units, the power is located 16" on center from that side. Units with a tapered front (Arm and Armless) under 45" in length cannot have power on the same side as the arm feature. For units 46" and longer, both left and right power options are available. Units with two arms under 45" in length cannot have power, and power is not available for corner or endcap units.

#### Example

UB1 - Under mount, black, position 1  
FHB12 - Flush mount, hardwired, black, positions 1 & 2

### To Order Select Below

#### 1. Power Type

	<b>Power</b>
DC	DAISY CHAINED
--	STANDARD POWER

#### 2. Mount Type

	<b>Mount</b>	
UH	UNDER MOUNT HARDWIRE (ELEVATED)	<b>+849</b>
FH	FLUSH MOUNT HARDWIRE (PLINTH)	<b>+815</b>
U	UNDER MOUNT (ELEVATED)	<b>+648</b>
F	FLUSH MOUNT (PLINTH)	<b>+591</b>

Hardwire only available in Standard Power

#### 3. Color

	<b>Color</b>
W	WHITE
G	GRAY
B	BLACK

Flush mount only available in black and gray.

#### 4. Location

	<b>Location</b>
1	POSITION 1 (LEFT)
2	POSITION 2 (RIGHT)

# Luna

## SPECIFICATION GUIDE: PRODUCT INFORMATION, DAISY CHAIN POWER

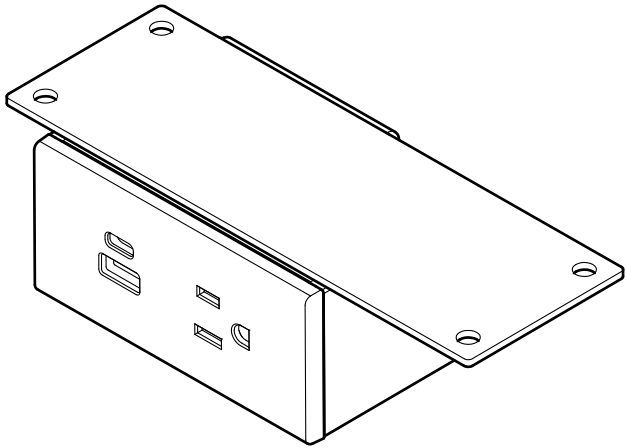
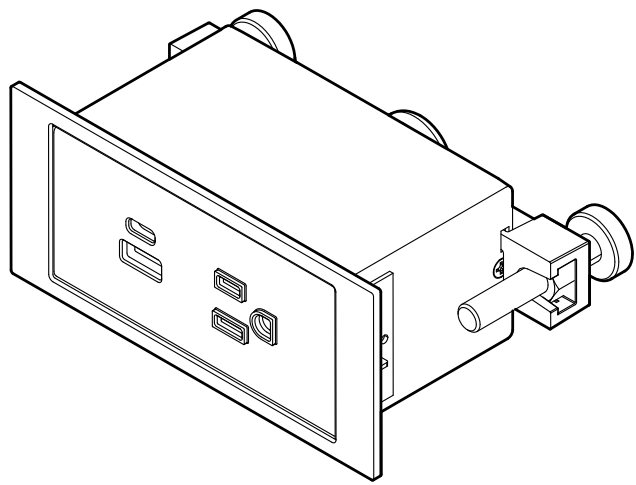
OVERVIEW	UNDER MOUNT (ELEVATED)	SURFACE MOUNT (PLINTH)	
<p><b>Power Units</b></p>			

### PRODUCT INFORMATION

#### Power

Elevated units offer undermount power beneath the seats, while plinth units offer flush mount power in the front. You can specify power units to be hardwired or equipped with a 3-prong plug. These units feature one USB-A port, one USB-C port, and a standard grounded 3-prong electrical outlet. Default cord lengths are 10 feet, with custom lengths available. Additional power options include daisy chain and wireless surface mount charging. Power units come with wire management clips for every 1-foot length of cord. Daisy chain infeeds are offered in 5', 10', and 15' standard lengths with a 3-prong plug.

#### Mounting Options

Under mount power is designated by (U) in the model code. Flush mount power is designated by (F) in the model code.

#### Cord Length

Both the standard cord and the conduit whip are 10ft long. Other lengths are available as a custom order.

#### Colors

Under-mount power units are offered in black (B), gray (G), and white (W), while flush-mount power units are available in black (B) and gray (G).

#### Cable Management

All elevated units include cable mounts and screws for assembly and installation. Power units come with wire management clips for every 1-foot length of cord.

For plinth units against a wall, the rear-side toe kick can be removed to allow for cord egress.

For plinth units not against a wall, the unit may be raised up by extending the glides or the installer may cut a small mouse hole in the toe kick. See assembly instructions for more information.

#### Location

On elevated units, the power is located under the front edge, next to the leg. For plinth units, the power is flush to the front, positioned 8" on center from the side of the unit. However, for arm and armless units, the power is located 16" on center from that side. Units with a tapered front (Arm and Armless) under 45" in length cannot have power on the same side as the arm feature. For units 46" and longer, both left and right power options are available. Units with two arms under 45" in length cannot have power, and power is not available for corner or endcap units.

#### Order Entry

Please get in touch with [designapplication@stylexdesign.com](mailto:designapplication@stylexdesign.com). CET is required for order entry to determine jumper lengths and system configuration. All daisy chain units are entered under 1 line.

### To Order Select Below

#### 1. Power System

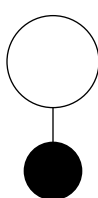

#### Luna Power System

LNPSBSU	DAISY CHAIN INFEED UNDER MOUNT (ELEVATED)	<b>+202</b>
LNPSBSF	DAISY CHAIN INFEED FLUSH MOUNT (PLINTH)	<b>+223</b>

#### 2. Jumpers

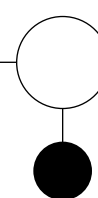

#### Jumpers

JUMPER, UNDER MOUNT (ELEVATED)	<b>+41</b>
JUMPER, FLUSH MOUNT (PLINTH)	<b>+61</b>
JUMPER EXTENSION	<b>+144</b>

Duplicate this charge based on the quantity of jumpers required.

# Luna

## SPECIFICATION GUIDE: DIMENSIONS, SEATING

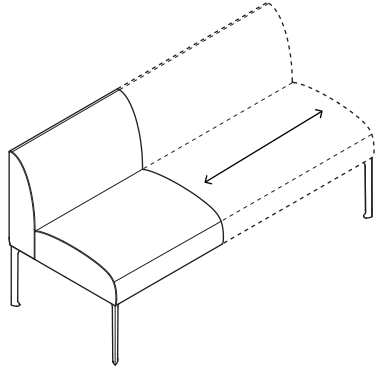
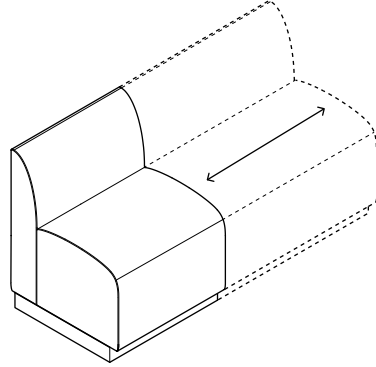
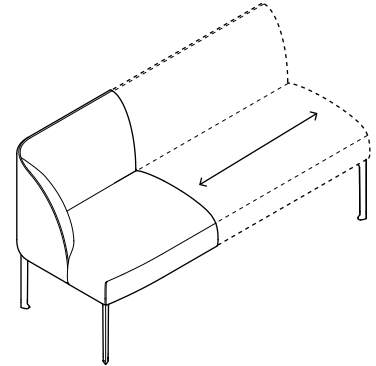
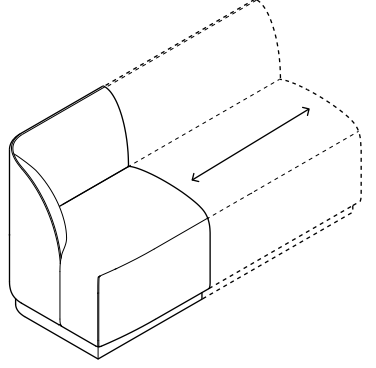
OVERVIEW		ELEVATED & PLINTH SEATING							
<p><b>Dimensions</b></p> <p>A. Overall Width            B. Overall Depth            C1. Overall Height Low Back            C2. Overall Height High Back            D. Seat Width            E. Seat Depth            F. Seat Height            G. Leg Height            H1. Back Height Low Back            H2. Back Height High Back</p> <p>Back and seat dimensions are based on compressed, seated dimensions.</p> <p>Elevated seating available without legs for customer's own millwork.</p>	 	<p><b>Standard</b></p> <p>A. 25 - 60            B. 25            C1. 31            C2. 38            D. 25 - 60            E. 19            F. 17.75            G. 12.25            H1. 13.75            H2. 20.75</p>	<p><b>Arm Left/Right</b></p> <p>A. 25 - 60            B. 25            C1. 31            C2. 38            D. 18 - 53            E. 19            F. 17.75            G. 12.25            H1. 13.75            H2. 20.75</p>	<p><b>Arm Both</b></p> <p>A. 30 - 60            B. 25            C1. 31            C2. 38            D. 16 - 46            E. 19            F. 17.75            G. 12.25            H1. 13.75            H2. 20.75</p>	<p><b>Armless End Left/Right</b></p> <p>A. 25 - 60            B. 25            C1. 31            C2. 38            D. 25 - 60            E. 19            F. 17.75            G. 12.25            H1. 13.75            H2. 20.75</p>	<p><b>Round Inside Corner</b></p> <p>A. 25            B. 25            C1. 31            C2. 38            D. 19            E. 19            F. 17.75            G. 12.25            H1. 13.75            H2. 20.75</p>	<p><b>Square Inside Corner</b></p> <p>A. 25            B. 25            C1. 31            C2. 38            D. 19            E. 19            F. 17.75            G. 12.25            H1. 13.75            H2. 20.75</p>	<p><b>Round Outside Corner</b></p> <p>A. 25            B. 25            C1. 31            C2. 38            D. 19            E. 19            F. 17.75            G. 12.25            H1. 13.75            H2. 20.75</p>	<p><b>Round End Cap</b></p> <p>A. 50 - 75            B. 25            C1. 31            C2. 38            D. 50 - 75            E. 19            F. 17.75            G. 12.25            H1. 13.75            H2. 20.75</p>
<p><b>Arm Choice</b></p> <p>A. Arm Width            B. Arm Depth</p>	 		<p><b>Arm Left/Right</b></p> <p>A. 7            B. 9</p>	<p><b>Arm Both</b></p> <p>A. 7            B. 9</p>					

# Luna

## SPECIFICATION GUIDE: DIMENSIONS, PLANTERS, TRAYS, TABLET

OVERVIEW	PLANTERS, FOR LOW BACK		PLANTERS, FOR HIGH BACK					
<p><b>Dimensions</b></p> <p>A. Width</p> <p>B. Depth</p> <p>C. Height</p>	<p><b>Single</b></p> <p>A. 15</p> <p>B. 15</p> <p>C. 31</p>		<p><b>Double</b></p> <p>A. 30</p> <p>B. 15</p> <p>C. 31</p>	<p><b>Single</b></p> <p>A. 15</p> <p>B. 15</p> <p>C. 38</p>	<p><b>Double</b></p> <p>A. 15</p> <p>B. 30</p> <p>C. 38</p>			
<p>A. Interior Height</p> <p>B. Interior Width (Top)</p> <p>C. Interior Width (Bottom)</p>	<p><b>Planter Liner</b></p> <p>A. 11.5</p> <p>B. 12.5</p> <p>C. 11.5</p>							
<p>A. Diameter</p> <p>B. Height Above Seat</p>	<p><b>Round Tray Table</b></p> <p>A. 13</p> <p>B. 2.5</p>	<p><b>Tablet Arm, Under Mount</b></p> <p>A. 14</p> <p>B. 8.5</p>	<p><b>Tablet Arm, Seat Mount</b></p> <p>A. 14</p> <p>B. 8.5</p>					
<p>A. Width</p> <p>B. Depth</p> <p>C. Height Above Seat</p>	<p><b>Wireless Charging Tray</b></p> <p>A. 8</p> <p>B. 13</p> <p>C. 3</p>							

# Luna

SPECIFICATION GUIDE: HOW TO ORDER, SEATING, ELEVATED

## MODEL CODE BREAKDOWN

Sample Model Code: LNE21L27DFSBBLUB12COM

1. Series	2. Type	3. Unit	4. Back Height	5. Length	6. Upholstery Options	7. Position	8. Layout Options	9. Leg Finish	10. Options	11. Upholstery
<b><u>LN</u></b>	<b><u>E</u></b>	<b><u>21</u></b>	<b><u>L</u></b>	<b><u>27</u></b>	<b><u>DF</u></b>	<b><u>S</u></b>	<b><u>B</u></b>	<b><u>BL</u></b>	<b><u>UB12</u></b>	<b><u>COM</u></b>
<b>Series</b> LN LUNA	<b>Type</b> E ELEVATED	<b>Unit</b> 11 STANDARD 21 ARM LEFT 22 ARM RIGHT 23 ARM BOTH 31 ARMLESS END LEFT 32 ARMLESS END RIGHT 41 ROUND INSIDE CORNER 42 SQUARE INSIDE CORNER 51 ROUND OUTSIDE CORNER 52 ROUND END CAP	<b>Back Height</b> H HIGH BACK L LOW BACK	<b>Width</b> XX CUSTOM LENGTH 25 WIDTH (CORNERS)  Units available by the inch between 25 - 60" • 11 - STANDARD • 21 - ARM LEFT • 22 - ARM RIGHT • 31 - ARMLESS LEFT • 32 - ARMLESS RIGHT  Units available by the inch between 30 - 60" • 23 - ARM BOTH  Units available by the inch between 50 - 75" • 52 - ROUND END CAP  Units required to be 25" • 41 - ROUND INSIDE CORNER • 42 - SQUARE INSIDE CORNER • 51 - ROUND OUTSIDE CORNER  Please note that arm both (23) units have a minimum width of 30" to ensure adequate seating width between the arms.	<b>Upholstery Options</b> DF DUAL UPHOLSTERY	<b>Position</b> F FREESTANDING S START M MID E END NL NO LEGS	<b>Layout Options</b> B BACK-TO-BACK  Back-to-back not available on mid units.  End units with arms cannot gang back-to-back via mid leg on the same side as the arm feature.	<b>Standard Powder Coated Metal</b> BL BLUE BM BLACK MATTE CP CHAMPAGNE DB DARK BRONZE DG DARK GRAY DP DUSTY PINK DS DARK SAGE LG LIGHT GRAY LL LILAC GRAY LP LIGHT PISTACHIO LR LIPSTICK RED MB MIDNIGHT BLUE MG MEADOW GREEN MK MILK MS METALLIC SILVER NK NICKEL OC OCHRE PY PALE YELLOW RO RED ORANGE RR RUSTY RED SB SOFT BLUE SD SAND TC TERRACOTTA TP TAUPE  <b>Other</b> AL POLISHED ALUMINUM	<b>Power Options</b> U___ UNDER MOUNT _B__ BLACK _G__ GRAY _W__ WHITE __H_ HARDWIRE ___1 POSITION 1 (LEFT) ___2 POSITION 2 (RIGHT)  <b>See power ordering options and rules.</b>  <b>Accessory Attachment</b> T TRAY/TABLET ARM ATTACHED TO UNIT  Accessory (tray table / tablet arm) attached to right side of seat unit. Not applicable for undermount tablet arms.  Please note that the table tray is a separate line item that must still be ordered. The 'T' designator above only indicates that the seat unit is configured to accommodate a table tray.	<b>Textile Grades</b> COM CUSTOMER'S OWN MATERIAL A GRADE A B GRADE B C GRADE C D GRADE D E GRADE E F GRADE F G GRADE G H GRADE H I GRADE I J GRADE J K GRADE K L GRADE L M GRADE M  Note: Select highest grade in the case of dual upholstery

# Luna

SPECIFICATION GUIDE: HOW TO ORDER, SEATING, PLINTH

## MODEL CODE BREAKDOWN

Sample Model Code: LNP21L27DFSBLM05FB12COM

1. Series	2. Type	3. Unit	4. Back Height	5. Length	6. Upholstery Options	7. Position	8. Layout Options	9. Plinth Finish	10. Options	11. Upholstery
<b><u>LN</u></b>	<b><u>P</u></b>	<b><u>21</u></b>	<b><u>L</u></b>	<b><u>27</u></b>	<b><u>DF</u></b>	<b><u>S</u></b>	<b><u>B</u></b>	<b><u>LM05</u></b>	<b><u>UB12</u></b>	<b><u>COM</u></b>
<b>Series</b> LN LUNA	<b>Type</b> P PLINTH	<b>Unit</b> 11 STANDARD 21 ARM LEFT 22 ARM RIGHT 23 ARM BOTH 31 ARMLESS END LEFT 32 ARMLESS END RIGHT 41 ROUND INSIDE CORNER 42 SQUARE INSIDE CORNER 51 ROUND OUTSIDE CORNER 52 ROUND END CAP	<b>Back Height</b> H HIGH BACK L LOW BACK	<b>Width</b> XX CUSTOM LENGTH 25 WIDTH (CORNERS)  Units available by the inch between 25 - 60" • 11 - STANDARD • 21 - ARM LEFT • 22 - ARM RIGHT • 31 - ARMLESS LEFT • 32 - ARMLESS RIGHT  Units available by the inch between 30 - 60" • 23 - ARM BOTH  Units available by the inch between 50 - 75" • 52 - ROUND END CAP  Units required to be 25" • 41 - ROUND INSIDE CORNER • 42 - SQUARE INSIDE CORNER • 51 - ROUND OUTSIDE CORNER  Please note that arm both (23) units have a minimum width of 30" to ensure adequate seating width between the arms.	<b>Upholstery Options</b> DF DUAL UPHOLSTERY	<b>Position</b> F FREESTANDING S START M MID E END NL NO LEGS	<b>Layout Options</b> B BACK-TO-BACK  Back-to-back not available on mid units.  End units with arms cannot gang back-to-back via mid leg on the same side as the arm feature.	<b>Plinth Toe Kick Finish</b> LM05 DOVE GRAY LM09 BLACK LM14 WALNUT HEIGHTS LM18 CASTLE OAK	<b>Power Options</b> F___ FLUSH MOUNT _B__ BLACK _G__ GRAY __H_ HARDWIRE ___1 POSITION 1 (LEFT) ___2 POSITION 2 (RIGHT)  <b>See power ordering options and rules.</b>  <b>Accessory Attachment</b> T TRAY/TABLET ARM ATTACHED TO UNIT  Accessory (tray table / tablet arm) attached to right side of seat unit. Not applicable for undermount tablet arms	<b>Textile Grades</b> COM CUSTOMER'S OWN MATERIAL A GRADE A B GRADE B C GRADE C D GRADE D E GRADE E F GRADE F G GRADE G H GRADE H I GRADE I J GRADE J K GRADE K L GRADE L M GRADE M  Note: Select highest grade in the case of dual upholstery

# Luna

SPECIFICATION GUIDE: HOW TO ORDER, TRAY AND TABLET

---

## MODEL CODE BREAKDOWN

---

Sample Model Code: LNE72SW81BM

1. Series

2. Type

3. Top Finish

4. Finish

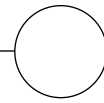
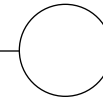
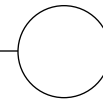
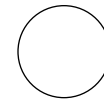

**LN** **72**

**SW81**

**BM**

### Series

LN LUNA

### Type

71 ROUND TRAY TABLE  
 72 WIRELESS CHARGING TRAY  
 75 TABLET ARM, UNDER MOUNT SINGLE SWIVEL  
 76 TABLET ARM, UNDER MOUNT DUAL SWIVEL  
 77 TABLET ARM, SEAT MOUNT SINGLE SWIVEL  
 78 TABLET ARM, SEAT MOUNT DUAL SWIVEL

### Wood Finish

SW81 WHITE OAK  
 SW83 MAPLE  
 SW85 WALNUT  
 SW87 OPAQUE BLACK

Not applicable for Round Table Tray

### Standard Powder Coated Metal

BL BLUE  
 BM BLACK MATTE  
 CP CHAMPAGNE  
 DB DARK BRONZE  
 DG DARK GRAY  
 DP DUSTY PINK  
 DS DARK SAGE  
 LG LIGHT GRAY  
 LL LILAC GRAY  
 LP LIGHT PISTACHIO  
 LR LIPSTICK RED  
 MB MIDNIGHT BLUE  
 MG MEADOW GREEN  
 MK MILK  
 MS METALLIC SILVER  
 NK NICKEL  
 OC OCHRE  
 PY PALE YELLOW  
 RO RED ORANGE  
 RR RUSTY RED  
 SB SOFT BLUE  
 SD SAND  
 TC TERRACOTTA  
 TP TAUPE

Not applicable for Wireless Charging Tray



# Luna

SPECIFICATION GUIDE: HOW TO ORDER, PLANTER

---

## MODEL CODE BREAKDOWN

---

Sample Model Code: LN6P2ABLM09

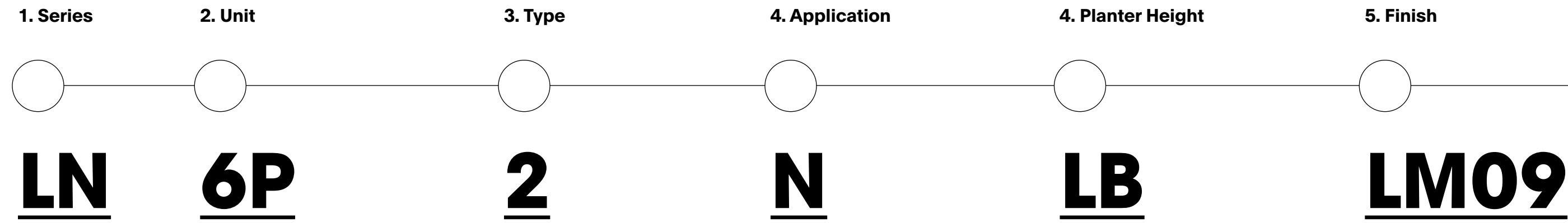

**Series**  
LN LUNA

**Unit**  
6P PLANTER

**Type**  
1 SINGLE  
2 DOUBLE

**Application**  
A ENCLOSED  
B EXPOSED

Enclosed planters (A) are not designed to be exposed, they must be surrounded by seating units. They utilize a butt-joint construction. Exposed planters (B) can be specified in any application and use a miter-joint construction.

**Back Height**  
LB LOW BACK  
HB HIGH BACK

**Finish**  
LM05 DOVE GRAY  
LM09 BLACK  
LM14 WALNUT HEIGHTS  
LM18 CASTLE OAK  
WV46 NATURAL FLAT CUT WALNUT  
WV48 NATURAL WHITE OAK

Black Laminate, LM09 is the only available planter finish for Enclosed planters.

# Luna

COLORS, MATERIALS, AND FINISHES

---

## POWDER COATED METAL

---

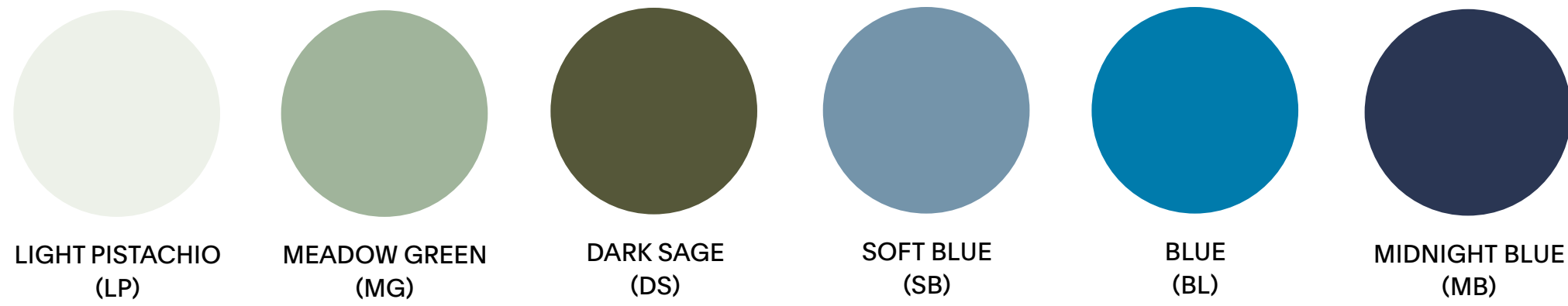
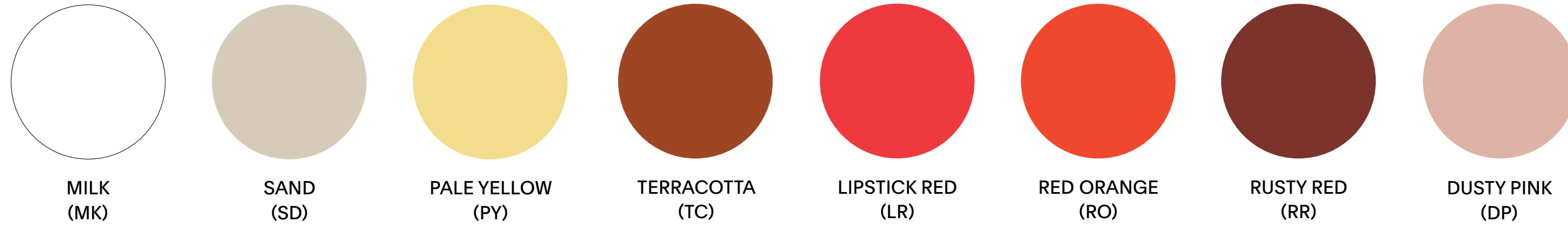

---

## SOLID WOOD

---



---

## LAMINATE

---



---

## WOOD VENEER

---



# Luna

ELEVATED: STANDARD

	WIDTHS	SERIES	TYPE	UNIT	BACK HEIGHT	DIMENSIONS	Yardage Requirements			Textile Upholstery Grades														
							SEAT	BACK	BACK/SEAT	COM	A	B	C	D	E	F	G	H	I	J	K	L	M	
 <p><b>Elevated, Standard, Low Back</b></p>	25-30in Wide	LN	E	11	L	25-30W x 25D x 31H	1	1.3	2.2	2,082	2,241	2,331	2,419	2,508	2,598	2,696	2,791	2,907	3,045	3,206	3,377	3,542	3,701	
	31-35in Wide	LN	E	11	L	31-35W x 25D x 31H	1.3	1.4	2.6	2,293	2,476	2,579	2,681	2,783	2,887	2,999	3,109	3,242	3,400	3,586	3,782	3,972	4,156	
	36-40in Wide	LN	E	11	L	36-40W x 25D x 31H	1.4	1.6	2.8	2,504	2,704	2,815	2,926	3,037	3,149	3,272	3,390	3,535	3,708	3,909	4,123	4,328	4,528	
	41-45in Wide	LN	E	11	L	41-45W x 25D x 31H	1.5	1.7	3.1	2,715	2,938	3,064	3,187	3,312	3,437	3,574	3,708	3,870	4,063	4,289	4,528	4,759	4,983	
	46-50in Wide	LN	E	11	L	46-50W x 25D x 31H	1.7	1.9	3.5	2,927	3,173	3,312	3,449	3,587	3,726	3,878	4,026	4,205	4,418	4,670	4,934	5,189	5,436	
	51-55in Wide	LN	E	11	L	51-55W x 25D x 31H	1.8	2	3.8	3,138	3,408	3,561	3,711	3,863	4,014	4,181	4,343	4,540	4,774	5,049	5,338	5,619	5,891	
	56-60in Wide	LN	E	11	L	56-60W x 25D x 31H	2	2.2	4.1	3,349	3,643	3,810	3,972	4,137	4,304	4,484	4,660	4,874	5,129	5,429	5,744	6,049	6,344	
 <p><b>Elevated, Standard, High Back</b></p>	25-30in Wide	LN	E	11	H	25-30W x 25D x 38H	1	2.1	3	2,203	2,418	2,539	2,657	2,778	2,900	3,032	3,160	3,316	3,502	3,720	3,951	4,174	4,389	
	31-35in Wide	LN	E	11	H	31-35W x 25D x 38H	1.3	2.4	3.5	2,420	2,667	2,806	2,942	3,080	3,220	3,372	3,519	3,698	3,911	4,163	4,427	4,682	4,930	
	36-40in Wide	LN	E	11	H	36-40W x 25D x 38H	1.4	2.7	4	2,636	2,923	3,085	3,243	3,404	3,565	3,741	3,912	4,120	4,369	4,660	4,967	5,263	5,550	
	41-45in Wide	LN	E	11	H	41-45W x 25D x 38H	1.5	3	4.4	2,853	3,171	3,350	3,527	3,704	3,884	4,080	4,270	4,501	4,778	5,101	5,442	5,772	6,091	
	46-50in Wide	LN	E	11	H	46-50W x 25D x 38H	1.7	2.7	4.3	3,070	3,380	3,555	3,726	3,901	4,076	4,267	4,452	4,678	4,946	5,262	5,595	5,917	6,228	
	51-55in Wide	LN	E	11	H	51-55W x 25D x 38H	1.8	3	4.7	3,286	3,620	3,808	3,994	4,181	4,369	4,575	4,775	5,018	5,307	5,647	6,005	6,351	6,686	
	56-60in Wide	LN	E	11	H	56-60W x 25D x 38H	2	3.2	5.1	3,503	3,869	4,075	4,278	4,482	4,689	4,914	5,133	5,399	5,716	6,088	6,480	6,860	7,227	

To Order Select Below

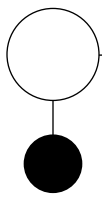
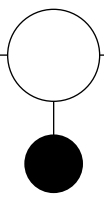
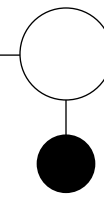
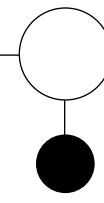
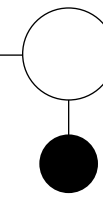
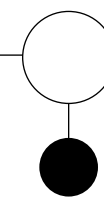
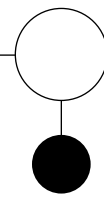
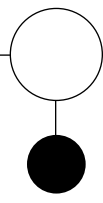
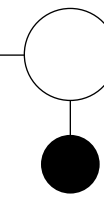
<p><b>1. Series/Type/Unit</b></p>  <hr/> <p>LNE11</p> <p><b>Luna Elevated Standard</b></p>	<p><b>2. Back Height</b></p>  <hr/> <p>H HIGH BACK</p> <p>L LOW BACK</p>	<p><b>3. Width</b></p>  <hr/> <p>XX WIDTH</p> <p>Available in 25-60"</p>	<p><b>4. Upholstery Options</b></p>  <hr/> <p>DF DUAL UPHOLSTERY</p>	<p><b>5. Position</b></p>  <hr/> <p>F FREESTANDING</p> <p>S START</p> <p>M MID</p> <p>E END</p> <p>NL NO LEGS <b>-177</b></p>	<p><b>6. Layout Options</b></p>  <hr/> <p>B BACK-TO-BACK</p> <p>Back-to-back not available on mid units.</p>	<p><b>7. Leg Finish</b></p>  <hr/> <p><b>Standard Powder Coated Metal</b></p> <p>BL BLUE</p> <p>BM BLACK MATTE</p> <p>CP CHAMPAGNE</p> <p>DB DARK BRONZE</p> <p>DG DARK GRAY</p> <p>DP DUSTY PINK</p> <p>DS DARK SAGE</p> <p>LG LIGHT GRAY</p> <p>LL LILAC GRAY</p> <p>LP LIGHT PISTACHIO</p> <p>LR LIPSTICK RED</p> <p>MB MIDNIGHT BLUE</p> <p><b>Polished Metal</b></p> <p>AL POLISHED ALUMINUM</p>	<p><b>8. Options</b></p>  <hr/> <p><b>Power Options</b></p> <p><b>See under mount power ordering options and rules.</b></p> <p><b>Accessory Attachment</b></p> <p>T TRAY/TABLET ARM ATTACHED TO UNIT</p> <p>Accessory attaches to right side of seat unit. Trays and tablet arm seat mount units can only be used between units. Not available on Arm Right Units.</p> <p>Please note that the table tray is a separate line item that must still be ordered. The 'T' designator above only indicates that the seat unit is configured to accommodate a table tray.</p>	<p><b>9. Upholstery</b></p>  <hr/> <p><b>See general information section for details on textile program and COM information.</b></p>
--	---	---	--	--	---	--	--	---

# Luna

ELEVATED: ARM LEFT OR RIGHT

	WIDTHS	SERIES	TYPE	UNIT	BACK HEIGHT	DIMENSIONS	Yardage Requirements			Textile Upholstery Grades														
							SEAT	BACK	BACK/SEAT	COM	A	B	C	D	E	F	G	H	I	J	K	L	M	
 <p><b>Elevated, Arm Left/Right, Low Back</b></p>	25-30in Wide	LN	E	21/22	L	25-30W x 25D x 31H	1.3	1.4	2.6	2,573	2,756	2,859	2,961	3,063	3,167	3,279	3,388	3,521	3,680	3,866	4,062	4,252	4,436	
	31-35in Wide	LN	E	21/22	L	31-35W x 25D x 31H	1.5	1.6	2.9	2,786	2,993	3,110	3,224	3,340	3,457	3,584	3,708	3,858	4,037	4,247	4,470	4,684	4,891	
	36-40in Wide	LN	E	21/22	L	36-40W x 25D x 31H	1.6	1.7	3.2	2,999	3,230	3,360	3,488	3,617	3,747	3,890	4,027	4,195	4,395	4,629	4,877	5,116	5,348	
	41-45in Wide	LN	E	21/22	L	41-45W x 25D x 31H	1.6	1.9	3.3	3,213	3,459	3,598	3,735	3,873	4,012	4,164	4,312	4,491	4,704	4,956	5,220	5,475	5,722	
	46-50in Wide	LN	E	21/22	L	46-50W x 25D x 31H	1.7	1.9	3.5	3,426	3,665	3,799	3,931	4,065	4,200	4,346	4,490	4,662	4,869	5,112	5,367	5,615	5,854	
	51-55in Wide	LN	E	21/22	L	51-55W x 25D x 31H	1.7	2	3.6	3,639	3,894	4,037	4,178	4,321	4,465	4,621	4,774	4,958	5,179	5,438	5,711	5,975	6,230	
	56-60in Wide	LN	E	21/22	L	56-60W x 25D x 31H	1.8	2.1	3.9	3,851	4,130	4,287	4,441	4,597	4,754	4,925	5,092	5,294	5,535	5,819	6,117	6,405	6,684	
 <p><b>Elevated, Arm Left/Right, High Back</b></p>	25-30in Wide	LN	E	21/22	H	25-30W x 25D x 38H	1.3	1.8	3	2,782	2,997	3,118	3,236	3,357	3,479	3,611	3,739	3,895	4,081	4,299	4,530	4,753	4,968	
	31-35in Wide	LN	E	21/22	H	31-35W x 25D x 38H	1.5	2.1	3.5	3,001	3,248	3,387	3,524	3,662	3,801	3,953	4,101	4,280	4,493	4,744	5,009	5,263	5,511	
	36-40in Wide	LN	E	21/22	H	36-40W x 25D x 38H	1.6	2.4	3.9	3,220	3,499	3,656	3,810	3,966	4,123	4,294	4,461	4,662	4,904	5,188	5,486	5,774	6,053	
	41-45in Wide	LN	E	21/22	H	41-45W x 25D x 38H	1.7	2.7	4.3	3,438	3,748	3,923	4,094	4,269	4,444	4,635	4,820	5,046	5,314	5,631	5,963	6,285	6,596	
	46-50in Wide	LN	E	21/22	H	46-50W x 25D x 38H	1.6	2.2	3.7	3,657	3,920	4,067	4,212	4,360	4,507	4,670	4,827	5,017	5,245	5,512	5,793	6,065	6,328	
	51-55in Wide	LN	E	21/22	H	51-55W x 25D x 38H	1.7	2.4	4	3,875	4,162	4,323	4,481	4,643	4,804	4,980	5,151	5,359	5,608	5,899	6,206	6,502	6,789	
	56-60in Wide	LN	E	21/22	H	56-60W x 25D x 38H	1.8	2.6	4.3	4,093	4,403	4,578	4,750	4,924	5,099	5,290	5,476	5,701	5,970	6,286	6,619	6,940	7,251	

To Order Select Below

**1. Series/Type/Unit**

- LUNA ELEVATED ARM LEFT  
LNE21
- LUNA ELEVATED ARM RIGHT  
LNE22

Elevated Arm Right shown above

**2. Back Height**

- Back Height
- H HIGH BACK
- L LOW BACK

**3. Length**

- Length
  - XX LENGTH
- Available in 25-60"

**4. Upholstery Options**

- Upholstery Options
- DF DUAL UPHOLSTERY

**5. Postion**

- Position
- F FREESTANDING
- S START
- E END
- NL NO LEGS **-230**

**6. Leg Finish**

- Standard Powder Coated Metal
- BL BLUE
- BM BLACK MATTE
- CP CHAMPAGNE
- DB DARK BRONZE
- DG DARK GRAY
- DP DUSTY PINK
- DS DARK SAGE
- LG LIGHT GRAY
- LL LILAC GRAY
- LP LIGHT PISTACHIO
- LR LIPSTICK RED
- MB MIDNIGHT BLUE
- MG MEADOW GREEN
- MK MILK
- MS METALLIC SILVER
- NK NICKEL
- OC OCHRE
- PY PALE YELLOW
- RO RED ORANGE
- RR RUSTY RED
- SB SOFT BLUE
- SD SAND
- TC TERRACOTTA
- TP TAUPE
- Polished Metal
- AL POLISHED ALUMINUM

**7. Options**

- Power Options
- See under mount power ordering options and rules.
- Accessory Attachment
- T TRAY/TABLET ARM ATTACHED TO UNIT

Accessory attaches to right side of seat unit. Trays and tablet arm seat mount units can only be used between units. Not available on Arm Right Units.

Please note that the table tray is a separate line item that must still be ordered. The 'T' designator above only indicates that the seat unit is configured to accommodate a table tray.

**8. Upholstery**

- See general information section for details on textile program and COM information.

# Luna

ELEVATED: ARM BOTH

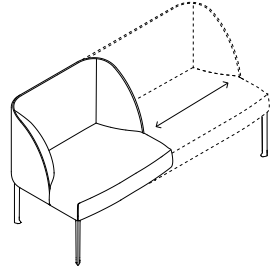
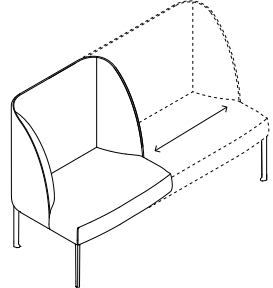
	WIDTHS	SERIES	TYPE	UNIT	BACK HEIGHT	DIMENSIONS	Yardage Requirements			Textile Upholstery Grades														
							SEAT	BACK	BACK/SEAT	COM	A	B	C	D	E	F	G	H	I	J	K	L	M	
	30-35in Wide	LN	E	23	L	30-35W x 25D x 31H	1.7	1.9	3.5	3,227	3,474	3,613	3,749	3,888	4,027	4,179	4,326	4,505	4,718	4,970	5,234	5,489	5,737	
	36-40in Wide	LN	E	23	L	36-40W x 25D x 31H	1.8	2	3.8	3,443	3,714	3,867	4,016	4,168	4,320	4,487	4,649	4,845	5,079	5,355	5,644	5,925	6,196	
	41-45in Wide	LN	E	23	L	41-45W x 25D x 31H	2	2.2	4.1	3,660	3,954	4,120	4,283	4,448	4,614	4,795	4,971	5,185	5,440	5,740	6,055	6,360	6,655	
	46-50in Wide	LN	E	23	L	46-50W x 25D x 31H	1.6	2.1	3.6	3,876	4,131	4,274	4,415	4,558	4,702	4,858	5,011	5,195	5,416	5,675	5,948	6,212	6,467	
	51-55in Wide	LN	E	23	L	51-55W x 25D x 31H	1.7	2.2	3.9	4,092	4,371	4,528	4,682	4,838	4,995	5,167	5,333	5,535	5,776	6,060	6,359	6,647	6,925	
	56-60in Wide	LN	E	23	L	56-60W x 25D x 31H	1.8	2.4	4.1	4,309	4,603	4,769	4,932	5,097	5,263	5,444	5,620	5,834	6,089	6,389	6,704	7,009	7,304	
	30-35in Wide	LN	E	23	H	30-35W x 25D x 38H	1.7	2	3.7	3,526	3,789	3,936	4,081	4,229	4,376	4,539	4,696	4,886	5,114	5,381	5,662	5,934	6,197	
	36-40in Wide	LN	E	23	H	36-40W x 25D x 38H	1.8	2.2	4	3,747	4,034	4,195	4,353	4,515	4,676	4,852	5,023	5,231	5,480	5,771	6,078	6,374	6,661	
	41-45in Wide	LN	E	23	H	41-45W x 25D x 38H	2	2.4	4.3	3,970	4,280	4,454	4,626	4,801	4,975	5,167	5,352	5,578	5,846	6,162	6,495	6,816	7,127	
	46-50in Wide	LN	E	23	H	46-50W x 25D x 38H	1.6	2.6	4	4,191	4,478	4,639	4,798	4,959	5,120	5,296	5,467	5,675	5,924	6,215	6,522	6,818	7,105	
	51-55in Wide	LN	E	23	H	51-55W x 25D x 38H	1.7	2.8	4.3	4,414	4,724	4,898	5,070	5,245	5,419	5,611	5,796	6,022	6,290	6,606	6,939	7,260	7,571	
	56-60in Wide	LN	E	23	H	56-60W x 25D x 38H	1.8	2.9	4.7	4,635	4,969	5,157	5,342	5,530	5,718	5,924	6,124	6,367	6,656	6,996	7,354	7,700	8,035	

To Order Select Below

1. Series/Type/Unit	2. Back Height	3. Length	4. Upholstery Options	5. Postion	6. Layout Options	7. Leg Finish	8. Options	9. Upholstery																																																		
●	●	●	●	●	●	●	●	●																																																		
LNE23 <b>Luna Elevated Arm Both</b>	H HIGH BACK L LOW BACK	XX LENGTH Available in 30-60"	DF DUAL UPHOLSTERY	F FREESTANDING NL NO LEGS <b>-283</b>	B BACK-TO-BACK  Back-to-back not available on mid units.  End units with arms cannot gang back-to-back via mid leg on the same side as the arm feature.	<p>● <b>Standard Powder Coated Metal</b></p> <table border="0"> <tr><td>BL</td><td>BLUE</td><td>MG</td><td>MEADOW GREEN</td></tr> <tr><td>BM</td><td>BLACK MATTE</td><td>MK</td><td>MILK</td></tr> <tr><td>CP</td><td>CHAMPAGNE</td><td>MS</td><td>METALLIC SILVER</td></tr> <tr><td>DB</td><td>DARK BRONZE</td><td>NK</td><td>NICKEL</td></tr> <tr><td>DG</td><td>DARK GRAY</td><td>OC</td><td>OCHRE</td></tr> <tr><td>DP</td><td>DUSTY PINK</td><td>PY</td><td>PALE YELLOW</td></tr> <tr><td>DS</td><td>DARK SAGE</td><td>RO</td><td>RED ORANGE</td></tr> <tr><td>LG</td><td>LIGHT GRAY</td><td>RR</td><td>RUSTY RED</td></tr> <tr><td>LL</td><td>LILAC GRAY</td><td>SB</td><td>SOFT BLUE</td></tr> <tr><td>LP</td><td>LIGHT PISTACHIO</td><td>SD</td><td>SAND</td></tr> <tr><td>LR</td><td>LIPSTICK RED</td><td>TC</td><td>TERRACOTTA</td></tr> <tr><td>MB</td><td>MIDNIGHT BLUE</td><td>TP</td><td>TAUPE</td></tr> </table> <p>● <b>Polished Metal</b></p> <table border="0"> <tr><td>AL</td><td>POLISHED ALUMINUM</td></tr> </table>	BL	BLUE	MG	MEADOW GREEN	BM	BLACK MATTE	MK	MILK	CP	CHAMPAGNE	MS	METALLIC SILVER	DB	DARK BRONZE	NK	NICKEL	DG	DARK GRAY	OC	OCHRE	DP	DUSTY PINK	PY	PALE YELLOW	DS	DARK SAGE	RO	RED ORANGE	LG	LIGHT GRAY	RR	RUSTY RED	LL	LILAC GRAY	SB	SOFT BLUE	LP	LIGHT PISTACHIO	SD	SAND	LR	LIPSTICK RED	TC	TERRACOTTA	MB	MIDNIGHT BLUE	TP	TAUPE	AL	POLISHED ALUMINUM	<p>● <b>Power Options</b></p> <p><b>See under mount power ordering options and rules.</b></p>	<p>● <b>See general information section for details on textile program and COM information</b></p>
BL	BLUE	MG	MEADOW GREEN																																																							
BM	BLACK MATTE	MK	MILK																																																							
CP	CHAMPAGNE	MS	METALLIC SILVER																																																							
DB	DARK BRONZE	NK	NICKEL																																																							
DG	DARK GRAY	OC	OCHRE																																																							
DP	DUSTY PINK	PY	PALE YELLOW																																																							
DS	DARK SAGE	RO	RED ORANGE																																																							
LG	LIGHT GRAY	RR	RUSTY RED																																																							
LL	LILAC GRAY	SB	SOFT BLUE																																																							
LP	LIGHT PISTACHIO	SD	SAND																																																							
LR	LIPSTICK RED	TC	TERRACOTTA																																																							
MB	MIDNIGHT BLUE	TP	TAUPE																																																							
AL	POLISHED ALUMINUM																																																									

# Luna

ELEVATED: ARMLESS LEFT OR RIGHT

	WIDTHS	SERIES	TYPE	UNIT	BACK HEIGHT	DIMENSIONS	Yardage Requirements			Textile Upholstery Grades														
							SEAT	BACK	BACK/SEAT	COM	A	B	C	D	E	F	G	H	I	J	K	L	M	
	25-30in Wide	LN	E	31/32	L	25-30W x 25D x 31H	1.3	1.3	2.5	2,204	2,380	2,477	2,574	2,673	2,772	2,879	2,984	3,111	3,262	3,440	3,629	3,810	3,985	
	31-35in Wide	LN	E	31/32	L	31-35W x 25D x 31H	1.5	1.4	2.8	2,415	2,615	2,726	2,836	2,947	3,060	3,182	3,301	3,446	3,618	3,820	4,033	4,239	4,439	
	36-40in Wide	LN	E	31/32	L	36-40W x 25D x 31H	1.6	1.6	3.1	2,626	2,849	2,974	3,097	3,223	3,348	3,485	3,618	3,780	3,974	4,200	4,439	4,670	4,893	
	41-45in Wide	LN	E	31/32	L	41-45W x 25D x 31H	1.7	1.7	3.3	2,837	3,076	3,210	3,343	3,477	3,611	3,758	3,901	4,074	4,281	4,523	4,779	5,026	5,266	
	46-50in Wide	LN	E	31/32	L	46-50W x 25D x 31H	1.7	1.9	3.5	3,048	3,295	3,434	3,570	3,709	3,848	4,000	4,148	4,326	4,540	4,791	5,055	5,310	5,558	
	51-55in Wide	LN	E	31/32	L	51-55W x 25D x 31H	1.8	2	3.8	3,259	3,530	3,683	3,832	3,984	4,136	4,302	4,465	4,661	4,895	5,171	5,460	5,741	6,012	
	56-60in Wide	LN	E	31/32	L	56-60W x 25D x 31H	2	2.1	4.1	3,470	3,765	3,931	4,093	4,259	4,425	4,606	4,782	4,996	5,251	5,550	5,866	6,170	6,466	
	25-30in Wide	LN	E	31/32	H	25-30W x 25D x 38H	1.3	2.1	3.3	2,330	2,569	2,703	2,835	2,969	3,103	3,250	3,394	3,566	3,773	4,015	4,271	4,519	4,758	
	31-35in Wide	LN	E	31/32	H	31-35W x 25D x 38H	1.5	2.5	3.8	2,547	2,817	2,970	3,120	3,272	3,424	3,590	3,752	3,949	4,183	4,458	4,748	5,028	5,300	
	36-40in Wide	LN	E	31/32	H	36-40W x 25D x 38H	1.6	2.8	4.3	2,763	3,073	3,248	3,420	3,594	3,769	3,960	4,145	4,371	4,639	4,956	5,288	5,610	5,921	
	41-45in Wide	LN	E	31/32	H	41-45W x 25D x 38H	1.7	3.1	4.8	2,980	3,322	3,514	3,703	3,896	4,088	4,299	4,503	4,752	5,048	5,397	5,763	6,117	6,460	
	46-50in Wide	LN	E	31/32	H	46-50W x 25D x 38H	1.7	2.7	4.2	3,197	3,500	3,669	3,837	4,006	4,177	4,363	4,544	4,763	5,025	5,333	5,657	5,971	6,273	
	51-55in Wide	LN	E	31/32	H	51-55W x 25D x 38H	1.8	2.9	4.7	3,413	3,747	3,935	4,120	4,308	4,496	4,702	4,902	5,145	5,434	5,774	6,132	6,478	6,813	
	56-60in Wide	LN	E	31/32	H	56-60W x 25D x 38H	2	3.1	5	3,630	3,987	4,189	4,388	4,588	4,790	5,011	5,225	5,485	5,795	6,159	6,543	6,914	7,273	

To Order Select Below

<p><b>1. Series/Type/Unit</b></p> <p>LUNA ELEVATED ARMLESS LEFT LNE31</p> <p>LUNA ELEVATED ARMLESS RIGHT LNE32</p> <p>Elevated Armless Right shown above</p>	<p><b>2. Back Height</b></p> <p>H HIGH BACK</p> <p>L LOW BACK</p>	<p><b>3. Width</b></p> <p>XX WIDTH</p> <p>Available in 25-60"</p>	<p><b>4. Upholstery Options</b></p> <p>DF DUAL UPHOLSTERY</p>	<p><b>5. Position</b></p> <p>F FREESTANDING</p> <p>S START</p> <p>E END</p> <p>NL NO LEGS <b>-230</b></p>	<p><b>6. Layout Options</b></p> <p>B BACK-TO-BACK</p> <p>Back-to-back not available on mid units.</p>	<p><b>7. Leg Finish</b></p> <p><b>Standard Powder Coated Metal</b></p> <p>BL BLUE</p> <p>BM BLACK MATTE</p> <p>CP CHAMPAGNE</p> <p>DB DARK BRONZE</p> <p>DG DARK GRAY</p> <p>DP DUSTY PINK</p> <p>DS DARK SAGE</p> <p>LG LIGHT GRAY</p> <p>LL LILAC GRAY</p> <p>LP LIGHT PISTACHIO</p> <p>LR LIPSTICK RED</p> <p>MB MIDNIGHT BLUE</p> <p><b>Polished Metal</b></p> <p>AL POLISHED ALUMINUM</p>	<p><b>8. Options</b></p> <p><b>Power Options</b></p> <p>See under mount power ordering options and rules.</p> <p><b>Accessory Attachment</b></p> <p>T TRAY/TABLET ARM ATTACHED TO UNIT</p> <p>Accessory attaches to right side of seat unit. Trays and tablet arm seat mount units can only be used between units. Not available on Arm Right Units.</p> <p>Please note that the table tray is a separate line item that must still be ordered. The 'T' designator above only indicates that the seat unit is configured to accommodate a table tray.</p>	<p><b>9. Upholstery</b></p> <p>See general information section for details on textile program and COM information.</p>
--	---	---	---	---	---	--	---	--

# Luna

ELEVATED: ROUND INSIDE CORNER

	WIDTH	SERIES	TYPE	UNIT	BACK HEIGHT	DIMENSIONS	Yardage Requirements			Textile Upholstery Grades													
							SEAT	BACK	BACK/SEAT	COM	A	B	C	D	E	F	G	H	I	J	K	L	M
 <p><b>Elevated, Round Inside Corner, Low Back</b></p>	25	LN	E	41	L	25W x 25D x 31H	0.8	1.7	2.4	2,328	2,495	2,589	2,681	2,775	2,869	2,972	3,072	3,194	3,338	3,508	3,687	3,860	4,028
 <p><b>Elevated, Round Inside Corner, High Back</b></p>	25	LN	E	41	H	25W x 25D x 38H	0.8	2.6	3.2	2,551	2,782	2,912	3,040	3,169	3,299	3,441	3,579	3,747	3,947	4,181	4,428	4,668	4,899

**To Order Select Below**

**1. Series/Type/Unit**

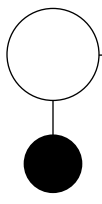

- LNE41
- Luna Elevated Round Inside Corner**

**2. Back Height**

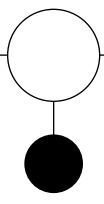

- Back Height**
- H HIGH BACK
- L LOW BACK

**3. Width**

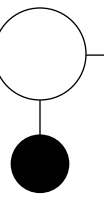

- Width**
- 25 WIDTH

**4. Upholstery Options**

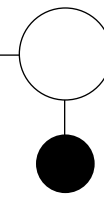

- Upholstery Options**
- DF DUAL UPHOLSTERY

**5. Position**

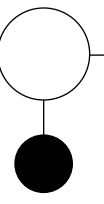

- Position**
- M MID
- NL NO LEGS **-177**

**6. Leg Finish**

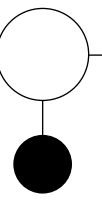

- Standard Powder Coated Metal**
- BL BLUE
- BM BLACK MATTE
- CP CHAMPAGNE
- DB DARK BRONZE
- DG DARK GRAY
- DP DUSTY PINK
- DS DARK SAGE
- LG LIGHT GRAY
- LL LILAC GRAY
- LP LIGHT PISTACHIO
- LR LIPSTICK RED
- MB MIDNIGHT BLUE
- MG MEADOW GREEN
- MK MILK
- MS METALLIC SILVER
- NK NICKEL
- OC OCHRE
- PY PALE YELLOW
- RO RED ORANGE
- RR RUSTY RED
- SB SOFT BLUE
- SD SAND
- TC TERRACOTTA
- TP TAUPE
- Polished Metal**
- AL POLISHED ALUMINUM

**7. Upholstery**

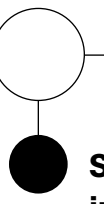

**See general information section for details on textile program and COM information**

# Luna

ELEVATED: SQUARE INSIDE CORNER

	WIDTH	SERIES	TYPE	UNIT	BACK HEIGHT	DIMENSIONS	Yardage Requirements			Textile Upholstery Grades													
							SEAT	BACK	BACK/SEAT	COM	A	B	C	D	E	F	G	H	I	J	K	L	M
 <p><b>Elevated, Square Inside Corner, Low Back</b></p>	25	LN	E	42	L	25W x 25D x 31H	0.8	1.7	2.4	2,296	2,464	2,557	2,650	2,744	2,838	2,941	3,041	3,163	3,307	3,477	3,656	3,829	3,997
 <p><b>Elevated, Square Inside Corner, High Back</b></p>	25	LN	E	42	H	25W x 25D x 38H	0.8	2.7	3.3	2,459	2,698	2,832	2,964	3,098	3,232	3,379	3,522	3,695	3,902	4,144	4,400	4,648	4,887

**To Order Select Below**

**1. Series/Type/Unit**

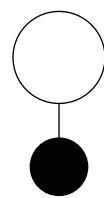

LNE42

**Luna**  
Elevated  
Square Inside Corner

**2. Back Height**

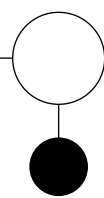

**Back Height**

H HIGH BACK  
L LOW BACK

**3. Width**

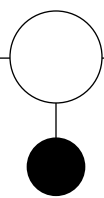

**Width**

25 WIDTH

**4. Upholstery Options**

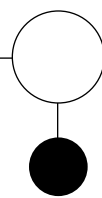

**Upholstery Options**

DF DUAL UPHOLSTERY

**5. Position**

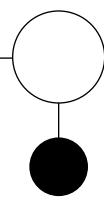

**Position**

M MID  
NL NO LEGS **-177**

**6. Leg Finish**

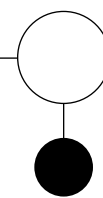

**Standard Powder Coated Metal**

BL BLUE	MG MEADOW GREEN
BM BLACK MATTE	MK MILK
CP CHAMPAGNE	MS METALLIC SILVER
DB DARK BRONZE	NK NICKEL
DG DARK GRAY	OC OCHRE
DP DUSTY PINK	PY PALE YELLOW
DS DARK SAGE	RO RED ORANGE
LG LIGHT GRAY	RR RUSTY RED
LL LILAC GRAY	SB SOFT BLUE
LP LIGHT PISTACHIO	SD SAND
LR LIPSTICK RED	TC TERRACOTTA
MB MIDNIGHT BLUE	TP TAUPE

**Polished Metal**

AL POLISHED ALUMINUM

**7. Upholstery**

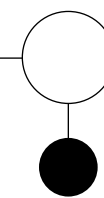

**See general information section for details on textile program and COM information**



# Luna

ELEVATED: ROUND OUTSIDE CORNER

	WIDTH	SERIES	TYPE	UNIT	BACK HEIGHT	DIMENSIONS	Yardage Requirements			Textile Upholstery Grades													
							SEAT	BACK	BACK/SEAT	COM	A	B	C	D	E	F	G	H	I	J	K	L	M
 Elevated, Round Outside Corner, Low Back	25	LN	E	51	L	25W x 25D x 31H	1.4	0.5	1.8	1,510	1,638	1,710	1,779	1,851	1,923	2,001	2,078	2,169	2,281	2,410	2,546	2,678	2,806
 Elevated, Round Outside Corner, High Back	25	LN	E	51	H	25W x 25D x 38H	1.4	0.5	1.8	1,626	1,753	1,825	1,895	1,967	2,038	2,116	2,193	2,285	2,396	2,525	2,661	2,793	2,921

To Order Select Below

1. Series/Type/Unit

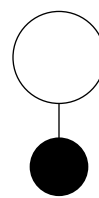

LNE51

**Luna**  
**Elevated**  
**Round Outside Corner**

2. Back Height

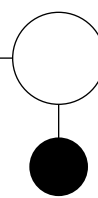

**Back Height**

H HIGH BACK  
L LOW BACK

3. Width

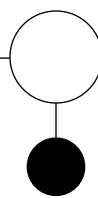

**Width**

25 WIDTH

4. Upholstery Options

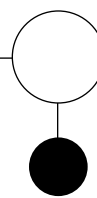

**Upholstery Options**

DF DUAL UPHOLSTERY

5. Position

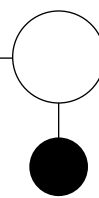

**Position**

M MID  
NL NO LEGS **-88**

6. Leg Finish

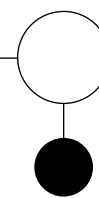

**Standard Powder Coated Metal**

BL BLUE	MG MEADOW GREEN
BM BLACK MATTE	MK MILK
CP CHAMPAGNE	MS METALLIC SILVER
DB DARK BRONZE	NK NICKEL
DG DARK GRAY	OC OCHRE
DP DUSTY PINK	PY PALE YELLOW
DS DARK SAGE	RO RED ORANGE
LG LIGHT GRAY	RR RUSTY RED
LL LILAC GRAY	SB SOFT BLUE
LP LIGHT PISTACHIO	SD SAND
LR LIPSTICK RED	TC TERRACOTTA
MB MIDNIGHT BLUE	TP TAUPE

**Polished Metal**

AL POLISHED ALUMINUM

7. Options



**Accessory Attachment**

T TRAY/TABLET ARM  
ATTACHED TO UNIT

Accessory attaches to right side of seat unit. Trays and tablet arm seat mount units can only be used between units. Not available on Arm Right Units.

Please note that the table tray is a separate line item that must still be ordered. The 'T' designator above only indicates that the seat unit is configured to accommodate a table tray.

8. Upholstery

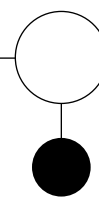

**See general information section for details on textile program and COM information**

# Luna

ELEVATED: ROUND END CAP

	WIDTHS	SERIES	TYPE	UNIT	BACK HEIGHT	DIMENSIONS	Yardage Requirements			Textile Upholstery Grades														
							SEAT	BACK	BACK/SEAT	COM	A	B	C	D	E	F	G	H	I	J	K	L	M	
	Elevated, Round End Cap, Low Back	50-55in Wide	LN	E	52	L	50-55W x 25D x 31H	1.9	0.7	2.6	2,973	3,156	3,259	3,361	3,463	3,567	3,680	3,789	3,922	4,080	4,266	4,463	4,652	4,836
	56-60in Wide	LN	E	52	L	56-60W x 25D x 31H	1.9	0.8	2.7	3,093	3,284	3,391	3,498	3,605	3,712	3,829	3,944	4,082	4,248	4,442	4,647	4,844	5,036	
	61-65in Wide	LN	E	52	L	61-65W x 25D x 31H	2	1	3	3,212	3,427	3,547	3,666	3,787	3,908	4,040	4,168	4,324	4,510	4,729	4,960	5,182	5,398	
	66-70in Wide	LN	E	52	L	66-70W x 25D x 31H	2.1	1.1	3.2	3,331	3,562	3,692	3,820	3,949	4,079	4,221	4,359	4,527	4,727	4,961	5,208	5,448	5,679	
	71-75in Wide	LN	E	52	L	71-75W x 25D x 31H	2.2	1.4	3.6	3,450	3,704	3,848	3,988	4,132	4,275	4,431	4,584	4,768	4,990	5,249	5,521	5,786	6,040	
	Elevated, Round End Cap, High Back	50-55in Wide	LN	E	52	H	50-55W x 25D x 38H	1.9	0.9	2.8	3,059	3,258	3,370	3,480	3,591	3,703	3,826	3,945	4,089	4,262	4,464	4,677	4,883	5,082
	56-60in Wide	LN	E	52	H	56-60W x 25D x 38H	1.9	1	2.9	3,174	3,381	3,498	3,612	3,728	3,845	3,972	4,096	4,246	4,425	4,635	4,858	5,072	5,279	
	61-65in Wide	LN	E	52	H	61-65W x 25D x 38H	2	1.4	3.3	3,291	3,530	3,664	3,796	3,930	4,064	4,211	4,354	4,527	4,734	4,976	5,232	5,480	5,719	
	66-70in Wide	LN	E	52	H	66-70W x 25D x 38H	2.1	1.6	3.7	3,406	3,669	3,817	3,961	4,109	4,257	4,419	4,576	4,766	4,994	5,261	5,542	5,815	6,078	
	71-75in Wide	LN	E	52	H	71-75W x 25D x 38H	2.2	1.9	4.1	3,521	3,816	3,982	4,144	4,310	4,476	4,657	4,833	5,047	5,302	5,601	5,917	6,221	6,517	

To Order Select Below

1. Series/Type/Unit

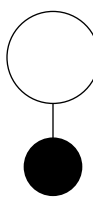

LNE52

**Luna  
Elevated  
Round End Cap**

2. Back Height

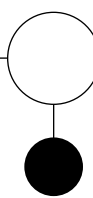

**Back Height**

H HIGH BACK  
L LOW BACK

3. Width

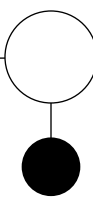

**Width**

XX WIDTH

Available in 50-75"  
  
65" is for wrapping around planters.

4. Upholstery Options

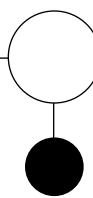

**Upholstery Options**

DF DUAL UPHOLSTERY

5. Position

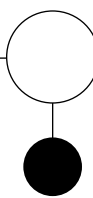

**Position**

M MID  
NL NO LEGS **-248**

6. Leg Finish

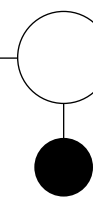

**Standard Powder Coated Metal**

BL BLUE  
BM BLACK MATTE  
CP CHAMPAGNE  
DB DARK BRONZE  
DG DARK GRAY  
DP DUSTY PINK  
DS DARK SAGE  
LG LIGHT GRAY  
LL LILAC GRAY  
LP LIGHT PISTACHIO  
LR LIPSTICK RED  
MB MIDNIGHT BLUE

MG MEADOW GREEN  
MK MILK  
MS METALLIC SILVER  
NK NICKEL  
OC OCHRE  
PY PALE YELLOW  
RO RED ORANGE  
RR RUSTY RED  
SB SOFT BLUE  
SD SAND  
TC TERRACOTTA  
TP TAUPE

**Polished Metal**

AL POLISHED ALUMINUM

7. Options

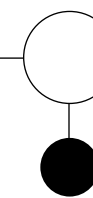

**Accessory Attachment**

T TRAY/TABLET ARM  
ATTACHED TO UNIT

Accessory attaches to right side of seat unit. Trays and tablet arm seat mount units can only be used between units. Not available on Arm Right Units.

Please note that the table tray is a separate line item that must still be ordered. The 'T' designator above only indicates that the seat unit is configured to accommodate a table tray.

8. Upholstery

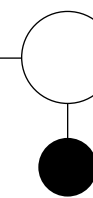

**See general information section for details on textile program and COM information**

# Luna

PLINTH: STANDARD

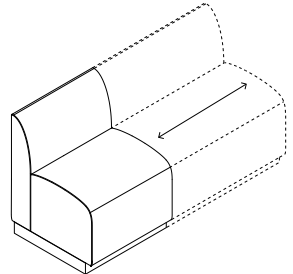
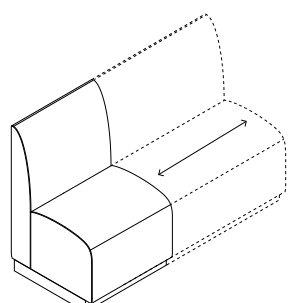
	WIDTHS	SERIES	TYPE	UNIT	BACK HEIGHT	DIMENSIONS	Yardage Requirements			Textile Upholstery Grades														
							SEAT	BACK	BACK/SEAT	COM	A	B	C	D	E	F	G	H	I	J	K	L	M	
 <p><b>Plinth, Standard, Low Back</b></p>	25-30in Wide	LN	P	11	L	25-30W x 25D x 31H	1.7	1.5	3	2,617	2,832	2,953	3,071	3,192	3,313	3,446	3,573	3,729	3,916	4,134	4,365	4,587	4,803	
	31-35in Wide	LN	P	11	L	31-35W x 25D x 31H	1.8	1.6	3.3	2,807	3,046	3,180	3,312	3,447	3,581	3,727	3,871	4,044	4,250	4,493	4,749	4,996	5,235	
	36-40in Wide	LN	P	11	L	36-40W x 25D x 31H	1.9	1.8	3.7	2,997	3,260	3,408	3,553	3,700	3,848	4,010	4,167	4,358	4,585	4,853	5,133	5,406	5,669	
	41-45in Wide	LN	P	11	L	41-45W x 25D x 31H	2.1	1.9	4	3,188	3,475	3,636	3,794	3,955	4,116	4,292	4,464	4,672	4,920	5,211	5,518	5,815	6,102	
	46-50in Wide	LN	P	11	L	46-50W x 25D x 31H	2.2	2.1	4.2	3,378	3,681	3,850	4,018	4,187	4,358	4,544	4,725	4,944	5,206	5,514	5,838	6,152	6,454	
	51-55in Wide	LN	P	11	L	51-55W x 25D x 31H	2.5	2.2	4.6	3,568	3,895	4,078	4,259	4,442	4,626	4,827	5,021	5,258	5,541	5,873	6,222	6,560	6,887	
	56-60in Wide	LN	P	11	L	56-60W x 25D x 31H	2.6	2.5	4.9	3,759	4,109	4,306	4,499	4,696	4,893	5,108	5,318	5,572	5,876	6,232	6,607	6,969	7,321	
 <p><b>Plinth, Standard, High Back</b></p>	25-30in Wide	LN	P	11	H	25-30W x 25D x 38H	1.7	2.4	3.9	2,766	3,045	3,202	3,356	3,512	3,669	3,841	4,007	4,209	4,450	4,734	5,033	5,321	5,599	
	31-35in Wide	LN	P	11	H	31-35W x 25D x 38H	1.8	2.7	4.3	3,006	3,316	3,490	3,662	3,837	4,011	4,203	4,388	4,613	4,882	5,198	5,531	5,852	6,163	
	36-40in Wide	LN	P	11	H	36-40W x 25D x 38H	1.9	3	4.9	3,245	3,595	3,792	3,985	4,182	4,379	4,595	4,804	5,059	5,362	5,718	6,093	6,455	6,807	
	41-45in Wide	LN	P	11	H	41-45W x 25D x 38H	2.1	3.2	5.3	3,484	3,866	4,081	4,292	4,506	4,722	4,957	5,185	5,462	5,794	6,182	6,592	6,987	7,369	
	46-50in Wide	LN	P	11	H	46-50W x 25D x 38H	2.2	2.9	5.1	3,723	4,089	4,295	4,498	4,703	4,910	5,134	5,354	5,619	5,936	6,309	6,701	7,080	7,447	
	51-55in Wide	LN	P	11	H	51-55W x 25D x 38H	2.5	3.1	5.5	3,962	4,361	4,584	4,804	5,027	5,252	5,496	5,735	6,024	6,368	6,772	7,199	7,611	8,010	
	56-60in Wide	LN	P	11	H	56-60W x 25D x 38H	2.6	3.3	5.9	4,201	4,622	4,860	5,093	5,330	5,567	5,826	6,079	6,386	6,751	7,179	7,632	8,068	8,491	

**To Order Select Below**

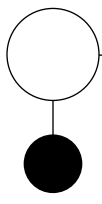
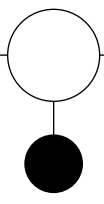
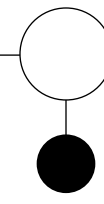
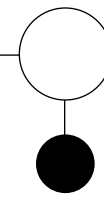
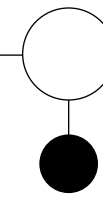
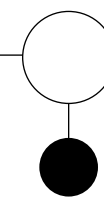
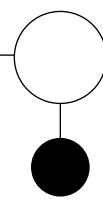
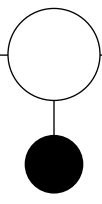
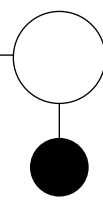
<p><b>1. Series/Type/Unit</b></p>  <hr/> <p>LNP11</p> <p><b>Luna Plinth Standard</b></p>	<p><b>2. Back Height</b></p>  <hr/> <p>H HIGH BACK</p> <p>L LOW BACK</p>	<p><b>3. Length</b></p>  <hr/> <p>XX LENGTH</p> <p>Available in 25-60"</p>	<p><b>4. Upholstery Options</b></p>  <hr/> <p>DF DUAL UPHOLSTERY</p>	<p><b>5. Postion</b></p>  <hr/> <p>F FREESTANDING</p> <p>S START</p> <p>M MID</p> <p>E END</p>	<p><b>6. Layout Options</b></p>  <hr/> <p>B BACK-TO-BACK</p> <p>Back-to-back not available on mid units.</p>	<p><b>7. Plinth Finish</b></p>  <hr/> <p>LM05 DOVE GRAY</p> <p>LM09 BLACK</p> <p>LM14 WALNUT HEIGHTS</p> <p>LM18 CASTLE OAK</p>	<p><b>8. Options</b></p>  <hr/> <p><b>Power Options</b></p> <p><b>See flush mount power ordering options and rules.</b></p> <hr/> <p><b>Accessory Attachment</b></p> <p>T TRAY/TABLET ARM ATTACHED TO UNIT</p>	<p><b>9. Upholstery</b></p>  <hr/> <p><b>See general information section for details on textile program and COM information</b></p>
--	---	---	--	---	---	--	---	--

Accessory attaches to right side of seat unit. Trays and tablet arm seat mount units can only be used between units. Not available on Arm Right Units.

Please note that the table tray is a separate line item that must still be ordered. The 'T' designator above only indicates that the seat unit is configured to accommodate a table tray.

# Luna

PLINTH: ARM LEFT OR RIGHT

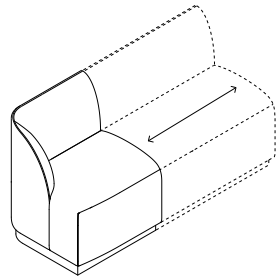
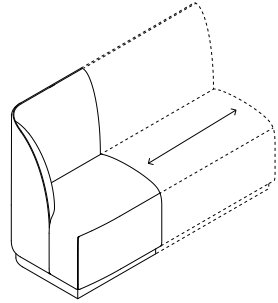
	WIDTHS	SERIES	TYPE	UNIT	BACK HEIGHT	DIMENSIONS	Yardage Requirements			Textile Upholstery Grades														
							SEAT	BACK	BACK/SEAT	COM	A	B	C	D	E	F	G	H	I	J	K	L	M	
 <p><b>Plinth, Arm Left/Right, Low Back</b></p>	25-30in Wide	LN	P	21/22	L	25-30W x 25D x 31H	1.5	1.6	3	3,214	3,429	3,550	3,668	3,789	3,910	4,042	4,170	4,326	4,513	4,731	4,962	5,184	5,400	
	31-35in Wide	LN	P	21/22	L	31-35W x 25D x 31H	1.7	1.8	3.3	3,407	3,646	3,780	3,912	4,047	4,181	4,327	4,471	4,644	4,851	5,093	5,349	5,596	5,835	
	36-40in Wide	LN	P	21/22	L	36-40W x 25D x 31H	1.8	1.9	3.7	3,599	3,863	4,010	4,155	4,302	4,450	4,612	4,769	4,960	5,188	5,455	5,736	6,008	6,271	
	41-45in Wide	LN	P	21/22	L	41-45W x 25D x 31H	1.9	2.1	4	3,792	4,079	4,240	4,398	4,559	4,721	4,896	5,068	5,276	5,524	5,816	6,122	6,419	6,706	
	46-50in Wide	LN	P	21/22	L	46-50W x 25D x 31H	2	2.2	4.1	3,984	4,279	4,445	4,607	4,773	4,939	5,120	5,296	5,510	5,765	6,064	6,379	6,684	6,979	
	51-55in Wide	LN	P	21/22	L	51-55W x 25D x 31H	2.1	2.4	4.4	4,177	4,495	4,674	4,851	5,028	5,208	5,404	5,594	5,825	6,102	6,425	6,766	7,096	7,415	
	56-60in Wide	LN	P	21/22	L	56-60W x 25D x 31H	2.2	2.5	4.7	4,369	4,703	4,891	5,076	5,263	5,452	5,658	5,857	6,101	6,390	6,730	7,088	7,434	7,769	
 <p><b>Plinth, Arm Left/Right, High Back</b></p>	25-30in Wide	LN	P	21/22	H	25-30W x 25D x 38H	1.5	2.4	3.7	3,457	3,720	3,868	4,012	4,160	4,308	4,470	4,627	4,817	5,045	5,312	5,593	5,866	6,129	
	31-35in Wide	LN	P	21/22	H	31-35W x 25D x 38H	1.7	2.6	4.1	3,697	3,992	4,158	4,320	4,486	4,652	4,833	5,009	5,223	5,478	5,777	6,092	6,397	6,692	
	36-40in Wide	LN	P	21/22	H	36-40W x 25D x 38H	1.8	2.9	4.6	3,937	4,264	4,447	4,628	4,811	4,995	5,196	5,390	5,627	5,910	6,242	6,592	6,930	7,256	
	41-45in Wide	LN	P	21/22	H	41-45W x 25D x 38H	1.9	3.2	5.1	4,178	4,544	4,750	4,952	5,157	5,364	5,589	5,808	6,074	6,391	6,763	7,155	7,535	7,902	
	46-50in Wide	LN	P	21/22	H	46-50W x 25D x 38H	2	3.2	5.2	4,418	4,792	5,002	5,209	5,419	5,630	5,859	6,084	6,355	6,679	7,060	7,460	7,848	8,222	
	51-55in Wide	LN	P	21/22	H	51-55W x 25D x 38H	2.1	3.6	5.5	4,658	5,056	5,280	5,500	5,723	5,948	6,192	6,430	6,719	7,064	7,468	7,895	8,306	8,706	
	56-60in Wide	LN	P	21/22	H	56-60W x 25D x 38H	2.2	3.8	6	4,898	5,328	5,570	5,807	6,049	6,291	6,555	6,812	7,124	7,496	7,933	8,394	8,839	9,270	

To Order Select Below

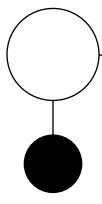
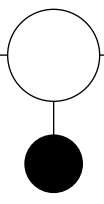
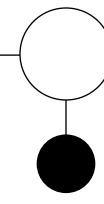
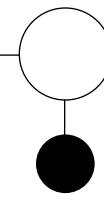
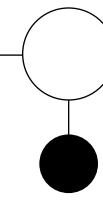
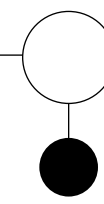
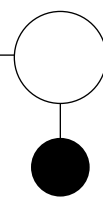
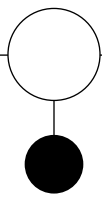
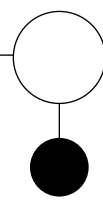
<p><b>1. Series/Type/Unit</b></p>  <p>LUNA PLINTH ARM LEFT LNP21</p> <p>LUNA PLINTH ARM RIGHT LNP22</p>	<p><b>2. Back Height</b></p>  <p>H HIGH BACK</p> <p>L LOW BACK</p>	<p><b>3. Length</b></p>  <p>XX LENGTH</p> <p>Available in 25-60"</p>	<p><b>4. Upholstery Options</b></p>  <p>DF DUAL UPHOLSTERY</p>	<p><b>5. Postion</b></p>  <p>F FREESTANDING</p> <p>S START</p> <p>E END</p>	<p><b>6. Layout Options</b></p>  <p>B BACK-TO-BACK</p> <p>Back-to-back not available on mid units.</p>	<p><b>7. Plinth Finish</b></p>  <p>LM05 DOVE GRAY</p> <p>LM09 BLACK</p> <p>LM14 WALNUT HEIGHTS</p> <p>LM18 CASTLE OAK</p>	<p><b>8. Options</b></p>  <p><b>Power Options</b></p> <p>See flush mount power ordering options and rules.</p> <p><b>Accessory Attachment</b></p> <p>T TRAY/TABLET ARM ATTACHED TO UNIT</p>	<p><b>9. Upholstery</b></p>  <p>See general information section for details on textile program and COM information</p>
---	---	---	--	--	---	--	--	---

Plinth Arm Right shown above

Accessory attaches to right side of seat unit. Trays and tablet arm seat mount units can only be used between units. Not available on Arm Right Units.

Please note that the table tray is a separate line item that must still be ordered. The 'T' designator above only indicates that the seat unit is configured to accommodate a table tray.

# Luna

PLINTH: ARM BOTH

	WIDTHS	SERIES	TYPE	UNIT	BACK HEIGHT	DIMENSIONS	Yardage Requirements			Textile Upholstery Grades														
							SEAT	BACK	BACK/SEAT	COM	A	B	C	D	E	F	G	H	I	J	K	L	M	
 <p><b>Plinth, Arm Both, Low Back</b></p>	30-35in Wide	LN	P	23	L	30-35W x 25D x 31H	1.4	2	3.2	4,115	4,346	4,476	4,604	4,733	4,863	5,006	5,143	5,311	5,511	5,745	5,992	6,232	6,464	
	36-40in Wide	LN	P	23	L	36-40W x 25D x 31H	1.5	2.1	3.5	4,313	4,559	4,699	4,835	4,973	5,113	5,264	5,412	5,591	5,804	6,056	6,320	6,575	6,822	
	41-45in Wide	LN	P	23	L	41-45W x 25D x 31H	1.6	2.4	3.8	4,509	4,780	4,933	5,082	5,234	5,386	5,553	5,715	5,911	6,145	6,421	6,710	6,991	7,262	
	46-50in Wide	LN	P	23	L	46-50W x 25D x 31H	1.7	2.5	4.1	4,707	5,001	5,168	5,330	5,495	5,662	5,843	6,018	6,233	6,488	6,787	7,102	7,407	7,702	
	51-55in Wide	LN	P	23	L	51-55W x 25D x 31H	1.8	2.6	4.3	4,905	5,215	5,389	5,561	5,736	5,910	6,102	6,287	6,512	6,781	7,097	7,430	7,751	8,062	
	56-60in Wide	LN	P	23	L	56-60W x 25D x 31H	2	2.8	4.7	5,101	5,435	5,623	5,808	5,996	6,184	6,390	6,589	6,833	7,122	7,462	7,820	8,166	8,501	
 <p><b>Plinth, Arm Both, High Back</b></p>	30-35in Wide	LN	P	23	H	30-35W x 25D x 38H	1.4	2.8	4	4,455	4,742	4,904	5,062	5,223	5,384	5,560	5,731	5,939	6,188	6,479	6,786	7,082	7,369	
	36-40in Wide	LN	P	23	H	36-40W x 25D x 38H	1.5	3	4.3	4,663	4,973	5,148	5,320	5,494	5,669	5,860	6,046	6,271	6,540	6,856	7,188	7,510	7,821	
	41-45in Wide	LN	P	23	H	41-45W x 25D x 38H	1.6	3.2	4.7	4,871	5,205	5,393	5,579	5,766	5,954	6,160	6,360	6,603	6,892	7,232	7,590	7,936	8,271	
	46-50in Wide	LN	P	23	H	46-50W x 25D x 38H	1.7	3.6	5.1	5,079	5,445	5,651	5,854	6,059	6,266	6,491	6,710	6,975	7,292	7,665	8,057	8,436	8,804	
	51-55in Wide	LN	P	23	H	51-55W x 25D x 38H	1.8	3.8	5.5	5,287	5,686	5,909	6,129	6,352	6,577	6,821	7,060	7,349	7,693	8,097	8,524	8,936	9,335	
	56-60in Wide	LN	P	23	H	56-60W x 25D x 38H	2	4	5.9	5,495	5,917	6,155	6,388	6,625	6,862	7,121	7,374	7,680	8,045	8,474	8,926	9,363	9,785	

**To Order Select Below**

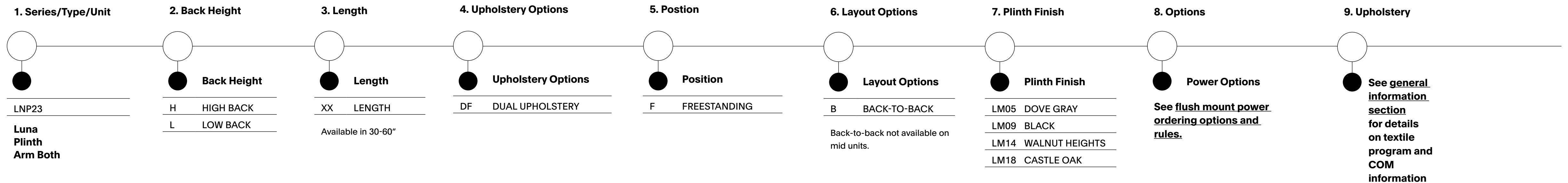

# Luna

PLINTH: ARMLESS LEFT OR RIGHT

	WIDTHS	SERIES	TYPE	UNIT	BACK HEIGHT	DIMENSIONS	Yardage Requirements			Textile Upholstery Grades														
							SEAT	BACK	BACK/SEAT	COM	A	B	C	D	E	F	G	H	I	J	K	L	M	
	25-30in Wide	LN	P	31/32	L	25-30W x 25D x 31H	1.6	1.3	2.8	2,731	2,931	3,042	3,152	3,264	3,376	3,499	3,617	3,762	3,934	4,136	4,349	4,555	4,755	
	31-35in Wide	LN	P	31/32	L	31-35W x 25D x 31H	1.8	1.5	3.1	2,958	3,180	3,306	3,429	3,555	3,680	3,817	3,950	4,112	4,306	4,531	4,770	5,001	5,225	
	36-40in Wide	LN	P	31/32	L	36-40W x 25D x 31H	1.9	1.6	3.5	3,183	3,430	3,569	3,706	3,844	3,983	4,135	4,283	4,462	4,675	4,926	5,191	5,445	5,693	
	41-45in Wide	LN	P	31/32	L	41-45W x 25D x 31H	2.1	1.7	3.8	3,409	3,680	3,832	3,982	4,134	4,286	4,452	4,614	4,811	5,045	5,321	5,610	5,891	6,162	
	46-50in Wide	LN	P	31/32	L	46-50W x 25D x 31H	2.2	1.9	4	3,635	3,922	4,083	4,241	4,402	4,564	4,739	4,911	5,119	5,367	5,659	5,965	6,262	6,549	
	51-55in Wide	LN	P	31/32	L	51-55W x 25D x 31H	2.4	2	4.3	3,860	4,170	4,345	4,517	4,691	4,866	5,058	5,243	5,468	5,737	6,053	6,386	6,707	7,018	
	56-60in Wide	LN	P	31/32	L	56-60W x 25D x 31H	2.6	2.2	4.7	4,086	4,420	4,608	4,793	4,981	5,169	5,375	5,574	5,818	6,107	6,447	6,805	7,151	7,486	
	25-30in Wide	LN	P	31/32	H	25-30W x 25D x 38H	1.6	2.4	3.8	2,890	3,161	3,313	3,463	3,615	3,767	3,933	4,096	4,292	4,526	4,802	5,091	5,372	5,643	
	31-35in Wide	LN	P	31/32	H	31-35W x 25D x 38H	1.8	2.6	4.3	3,129	3,439	3,614	3,786	3,960	4,135	4,326	4,512	4,737	5,006	5,322	5,654	5,976	6,287	
	36-40in Wide	LN	P	31/32	H	36-40W x 25D x 38H	1.9	2.9	4.8	3,369	3,711	3,903	4,092	4,285	4,477	4,688	4,892	5,141	5,437	5,786	6,152	6,506	6,849	
	41-45in Wide	LN	P	31/32	H	41-45W x 25D x 38H	2.1	3.2	5.2	3,608	3,982	4,192	4,399	4,609	4,819	5,049	5,274	5,545	5,869	6,249	6,650	7,038	7,412	
	46-50in Wide	LN	P	31/32	H	46-50W x 25D x 38H	2.2	2.8	5	3,847	4,205	4,406	4,605	4,806	5,008	5,228	5,442	5,702	6,012	6,376	6,760	7,131	7,490	
	51-55in Wide	LN	P	31/32	H	51-55W x 25D x 38H	2.4	3	5.3	4,086	4,468	4,683	4,894	5,108	5,324	5,559	5,788	6,064	6,396	6,784	7,194	7,589	7,972	
	56-60in Wide	LN	P	31/32	H	56-60W x 25D x 38H	2.6	3.2	5.8	4,325	4,739	4,972	5,201	5,433	5,666	5,921	6,168	6,469	6,828	7,248	7,692	8,120	8,535	

To Order Select Below

<p><b>1. Series/Type/Unit</b></p> <p>LUNA PLINTH ARMLESS LEFT LNP31</p> <p>LUNA PLINTH ARMLESS RIGHT LNEP2</p> <p>Plinth Armless Right shown above</p>	<p><b>2. Back Height</b></p> <p>H HIGH BACK</p> <p>L LOW BACK</p>	<p><b>3. Width</b></p> <p>XX WIDTH</p> <p>Available in 25-60"</p>	<p><b>4. Upholstery Options</b></p> <p>DF DUAL UPHOLSTERY</p>	<p><b>5. Position</b></p> <p>F FREESTANDING</p> <p>S START</p> <p>E END</p>	<p><b>6. Layout Options</b></p> <p>B BACK-TO-BACK</p> <p>Back-to-back not available on mid units.</p>	<p><b>7. Plinth Finish</b></p> <p>LM05 DOVE GRAY</p> <p>LM09 BLACK</p> <p>LM14 WALNUT HEIGHTS</p> <p>LM18 CASTLE OAK</p>	<p><b>8. Options</b></p> <p>Power Options</p> <p>See flush mount power ordering options and rules.</p> <p>Accessory Attachment</p> <p>T TRAY/TABLET ARM ATTACHED TO UNIT</p> <p>Accessory attaches to right side of seat unit. Trays and tablet arm seat mount units can only be used between units. Not available on Arm Right Units.</p> <p>Please note that the table tray is a separate line item that must still be ordered. The 'T' designator above only indicates that the seat unit is configured to accommodate a table tray.</p>	<p><b>9. Upholstery</b></p> <p>See general information section for details on textile program and COM information</p>
--	---	---	---	---	---	--	---	---

# Luna

PLINTH: ROUND INSIDE CORNER

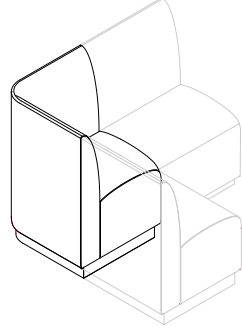
	WIDTH	SERIES	TYPE	UNIT	BACK HEIGHT	DIMENSIONS	Yardage Requirements			Textile Upholstery Grades													
							SEAT	BACK	BACK/SEAT	COM	A	B	C	D	E	F	G	H	I	J	K	L	M
 <p><b>Plinth, Round Inside Corner, Low Back</b></p>	25	LN	P	41	L	25W x 25D x 31H	1.3	2	3.2	2,803	3,034	3,164	3,292	3,421	3,551	3,693	3,830	3,999	4,198	4,432	4,680	4,919	5,151
 <p><b>Plinth, Round Inside Corner, High Back</b></p>	25	LN	P	41	H	25W x 25D x 38H	1.3	2.8	4	3,207	3,494	3,656	3,814	3,975	4,136	4,312	4,483	4,691	4,940	5,231	5,538	5,834	6,121

**To Order Select Below**

**1. Series/Type/Unit**

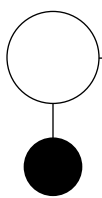

LNP41

**Luna  
Plinth  
Round Inside Corner**

**2. Back Height**

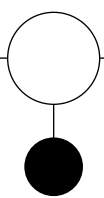

**Back Height**

H HIGH BACK

L LOW BACK

**3. Width**

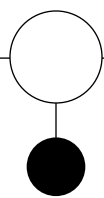

**Width**

25 WIDTH

**4. Upholstery Options**

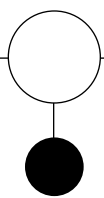

**Upholstery Options**

DF DUAL UPHOLSTERY

**5. Postion**

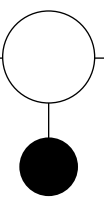

**Position**

M MID

**6. Plinth Finish**

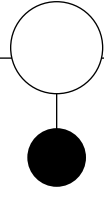

**Plinth Finish**

LM05 DOVE GRAY

LM09 BLACK

LM14 WALNUT HEIGHTS

LM18 CASTLE OAK

**7. Upholstery**

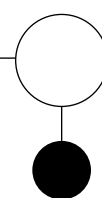

**See general  
information  
section  
for details  
on textile  
program and  
COM  
information**

# Luna

PLINTH: SQUARE INSIDE CORNER

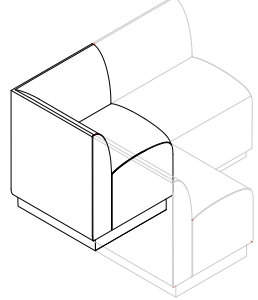
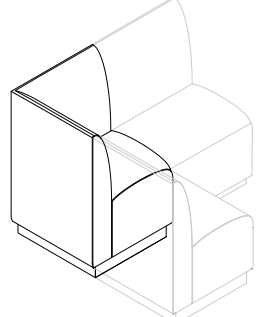
	WIDTH	SERIES	TYPE	UNIT	BACK HEIGHT	DIMENSIONS	Yardage Requirements			Textile Upholstery Grades													
							SEAT	BACK	BACK/SEAT	COM	A	B	C	D	E	F	G	H	I	J	K	L	M
 <p><b>Plinth, Square Inside Corner, Low Back</b></p>	25	LN	P	42	L	25W x 25D x 31H	1.3	2.1	3.2	2,874	3,104	3,234	3,362	3,491	3,621	3,764	3,901	4,070	4,269	4,503	4,751	4,990	5,222
 <p><b>Plinth, Square Inside Corner, High Back</b></p>	25	LN	P	42	H	25W x 25D x 38H	1.3	2.8	4	3,053	3,340	3,502	3,660	3,821	3,982	4,158	4,330	4,538	4,786	5,077	5,384	5,680	5,968

**To Order Select Below**

**1. Series/Type/Unit**

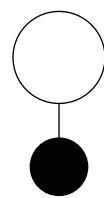

LNP42

**Luna  
Plinth  
Square Inside Corner**

**2. Back Height**

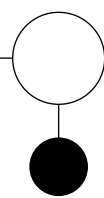

**Back Height**

H HIGH BACK

L LOW BACK

**3. Width**

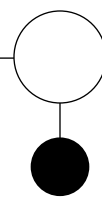

**Width**

25 WIDTH

**4. Upholstery Options**

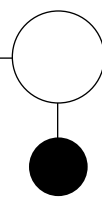

**Upholstery Options**

DF DUAL UPHOLSTERY

**5. Position**

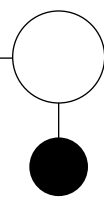

**Position**

M MID

**6. Plinth Finish**

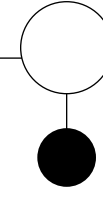

**Plinth Finish**

LM05 DOVE GRAY

LM09 BLACK

LM14 WALNUT HEIGHTS

LM18 CASTLE OAK

**7. Upholstery**

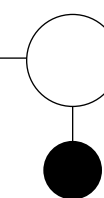

**See general information section for details on textile program and COM information**



# Luna

## PLINTH: ROUND OUTSIDE CORNER

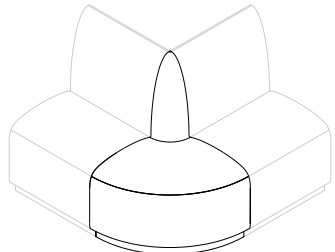
	WIDTH	SERIES	TYPE	UNIT	BACK HEIGHT	DIMENSIONS	Yardage Requirements			Textile Upholstery Grades													
							SEAT	BACK	BACK/SEAT	COM	A	B	C	D	E	F	G	H	I	J	K	L	M
 <p><b>Plinth, Round Outside Corner, Low Back</b></p>	25	LN	P	51	L	25W x 25D x 31H	1.9	0.5	2.4	2,056	2,224	2,317	2,410	2,503	2,598	2,701	2,801	2,922	3,067	3,236	3,415	3,589	3,756
 <p><b>Plinth, Round Outside Corner, High Back</b></p>	25	LN	P	51	H	25W x 25D x 38H	1.9	0.8	2.6	2,195	2,378	2,481	2,583	2,685	2,789	2,902	3,011	3,144	3,302	3,488	3,685	3,874	4,058

### To Order Select Below

#### 1. Series/Type/Unit

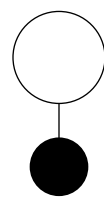

LNP51

**Luna  
Plinth  
Round Outside Corner**

#### 2. Back Height

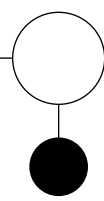

**Back Height**

H HIGH BACK  
L LOW BACK

#### 3. Width

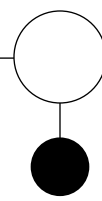

**Width**

25 WIDTH

#### 4. Upholstery Options

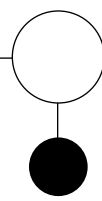

**Upholstery Options**

DF DUAL UPHOLSTERY

#### 5. Position

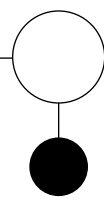

**Position**

M MID

#### 6. Options

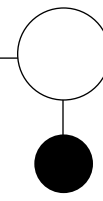

**Accessory Attachment**

T TRAY/TABLET ARM  
ATTACHED TO UNIT

Accessory attaches to right side of seat unit. Trays and tablet arm seat mount units can only be used between units. Not available on Arm Right Units.

Please note that the table tray is a separate line item that must still be ordered. The 'T' designator above only indicates that the seat unit is configured to accommodate a table tray.

#### 7. Plinth Finish

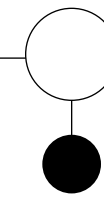

**Plinth Finish**

LM05 DOVE GRAY  
LM09 BLACK  
LM14 WALNUT HEIGHTS  
LM18 CASTLE OAK

#### 8. Upholstery

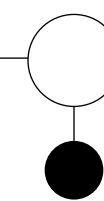

**See general information section for details on textile program and COM information**

# Luna

## PLINTH: ROUND END CAP

	WIDTHS	SERIES	TYPE	UNIT	BACK HEIGHT	DIMENSIONS	Yardage Requirements			Textile Upholstery Grades														
							SEAT	BACK	BACK/SEAT	COM	A	B	C	D	E	F	G	H	I	J	K	L	M	
	50-55in Wide	LN	P	52	L	50-55W x 25D x 31H	2.8	0.8	3.6	3,490	3,745	3,889	4,029	4,172	4,316	4,472	4,625	4,809	5,030	5,289	5,562	5,826	6,081	
	56-60in Wide	LN	P	52	L	56-60W x 25D x 31H	3	1	3.9	3,682	3,960	4,117	4,271	4,427	4,584	4,756	4,922	5,124	5,365	5,649	5,948	6,236	6,515	
	61-65in Wide	LN	P	52	L	61-65W x 25D x 31H	3	1.1	4.1	3,873	4,167	4,334	4,496	4,661	4,828	5,009	5,184	5,399	5,653	5,953	6,268	6,573	6,868	
	66-70in Wide	LN	P	52	L	66-70W x 25D x 31H	3	1.4	4.2	4,064	4,367	4,536	4,704	4,873	5,044	5,230	5,411	5,631	5,893	6,200	6,524	6,838	7,141	
	71-75in Wide	LN	P	52	L	71-75W x 25D x 31H	3	1.5	4.4	4,256	4,574	4,753	4,930	5,107	5,287	5,483	5,673	5,904	6,181	6,504	6,845	7,175	7,494	
	50-55in Wide	LN	P	52	H	50-55W x 25D x 38H	2.8	1.1	3.9	3,626	3,905	4,062	4,216	4,372	4,529	4,701	4,867	5,069	5,310	5,594	5,893	6,181	6,459	
	56-60in Wide	LN	P	52	H	56-60W x 25D x 38H	3	1.4	4.2	3,821	4,124	4,293	4,461	4,630	4,801	4,987	5,168	5,387	5,649	5,957	6,281	6,595	6,897	
	61-65in Wide	LN	P	52	H	61-65W x 25D x 38H	3	1.6	4.6	4,014	4,341	4,524	4,705	4,888	5,072	5,273	5,467	5,704	5,987	6,319	6,668	7,006	7,333	
	66-70in Wide	LN	P	52	H	66-70W x 25D x 38H	3	1.8	4.8	4,209	4,551	4,743	4,933	5,125	5,318	5,529	5,732	5,981	6,277	6,626	6,992	7,347	7,690	
	71-75in Wide	LN	P	52	H	71-75W x 25D x 38H	3.1	2.1	5.1	4,402	4,768	4,974	5,177	5,382	5,589	5,814	6,033	6,298	6,615	6,988	7,380	7,759	8,127	

### To Order Select Below

#### 1. Series/Type/Unit

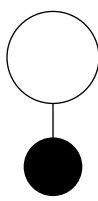

LNP52

**Luna  
Plinth  
Round End Cap**

#### 2. Back Height

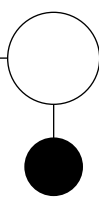

**Back Height**

H HIGH BACK  
L LOW BACK

#### 3. Width

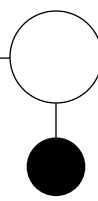

**Width**

XX WIDTH

Available in 50-75"

#### 4. Upholstery Options

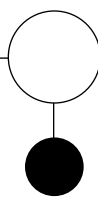

**Upholstery Options**

DF DUAL UPHOLSTERY

#### 5. Position

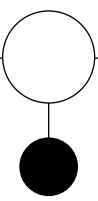

**Position**

M MID

#### 6. Options

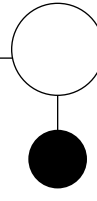

**Accessory Attachment**

TRAY/TABLET ARM  
ATTACHED TO UNIT

Accessory attaches to right side of seat unit. Trays and tablet arm seat mount units can only be used between units. Not available on Arm Right Units.

Please note that the table tray is a separate line item that must still be ordered. The 'T' designator above only indicates that the seat unit is configured to accommodate a table tray.

#### 7. Plinth Finish

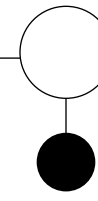

**Plinth Finish**

LM05 DOVE GRAY  
LM09 BLACK  
LM14 WALNUT HEIGHTS  
LM18 CASTLE OAK

#### 8. Upholstery

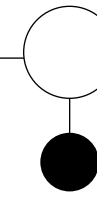

**See general information section for details on textile program and COM information**

# Luna

TRAY TABLE: ROUND OR WIRELESS CHARGING

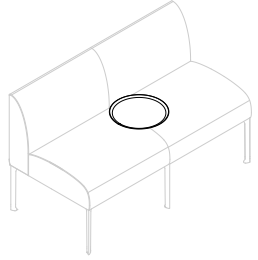
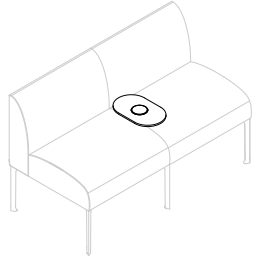
	SERIES	TYPE	DIMENSIONS	PRICE
<b>Tray Table, Round Tray Table</b> 	LN	71	13W x 13D	523
<b>Tray Table, Wireless Charging Tray</b> 	LN	72	8W x 13D	874

**To Order Select Below**

**1. Series/Type**

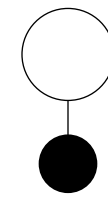

LN71	ROUND TRAY TABLE
LN72	WIRELESS CHARGING TRAY

**2. Top Finish**

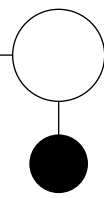

**Wood Finish**

SW81	WHITE OAK	
SW83	MAPLE	
SW85	WALNUT	<b>+73</b>
SW87	OPAQUE BLACK	

Only applicable for Wireless Charging Tray

**3. Finish**

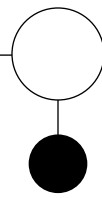

**Standard Powder Coated Metal**

BL	BLUE	MG	MEADOW GREEN
BM	BLACK MATTE	MK	MILK
CP	CHAMPAGNE	MS	METALLIC SILVER
DB	DARK BRONZE	NK	NICKEL
DG	DARK GRAY	OC	OCHRE
DP	DUSTY PINK	PY	PALE YELLOW
DS	DARK SAGE	RO	RED ORANGE
LG	LIGHT GRAY	RR	RUSTY RED
LL	LILAC GRAY	SB	SOFT BLUE
LP	LIGHT PISTACHIO	SD	SAND
LR	LIPSTICK RED	TC	TERRACOTTA
MB	MIDNIGHT BLUE	TP	TAUPE

Only applicable for Round Tray Table

# Luna

TABLET ARM: UNDER MOUNT

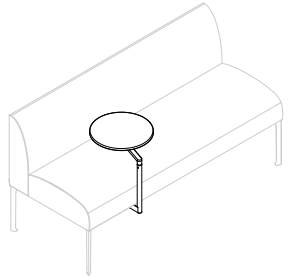
	SERIES	TYPE	DIMENSIONS	PRICE
<b>Tray Table, Tablet Arm, Under Single</b> 	LN	75	14W x 14D	832
<b>Tray Table, Tablet Arm, Under Dual</b> 	LN	76	14W x 14D	832

**To Order Select Below**

**1. Series/Type**

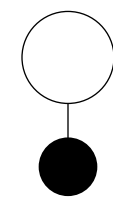

- LN75 UNDER MOUNT SINGLE SWIVEL
- LN76 UNDER MOUNT DUAL SWIVEL

**2. Top Finish**

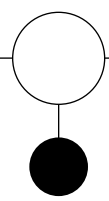

**Wood Finish**

- SW81 WHITE OAK
- SW83 MAPLE
- SW85 WALNUT **+73**
- SW87 OPAQUE BLACK

**3. Finish**

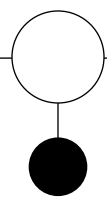

**Standard Powder Coated Metal**

- |                    |                    |
|--------------------|--------------------|
| BL BLUE            | MG MEADOW GREEN    |
| BM BLACK MATTE     | MK MILK            |
| CP CHAMPAGNE       | MS METALLIC SILVER |
| DB DARK BRONZE     | NK NICKEL          |
| DG DARK GRAY       | OC OCHRE           |
| DP DUSTY PINK      | PY PALE YELLOW     |
| DS DARK SAGE       | RO RED ORANGE      |
| LG LIGHT GRAY      | RR RUSTY RED       |
| LL LILAC GRAY      | SB SOFT BLUE       |
| LP LIGHT PISTACHIO | SD SAND            |
| LR LIPSTICK RED    | TC TERRACOTTA      |
| MB MIDNIGHT BLUE   | TP TAUPE           |

# Luna

TABLET ARM: SEAT MOUNT

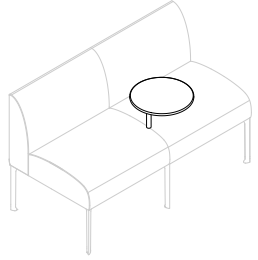
	SERIES	TYPE	DIMENSIONS	PRICE
<b>Tray Table, Tablet Arm, Seat Single</b> 	LN	77	14W x 14D	832
<b>Tray Table, Tablet Arm, Seat Dual</b> 	LN	78	14W x 14D	832

**To Order Select Below**

**1. Series/Type**

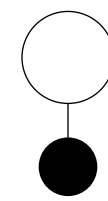

- LN77 SEAT MOUNT SINGLE SWIVEL
- LN78 SEAT MOUNT DUAL SWIVEL

**2. Top Finish**

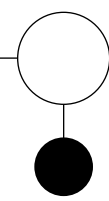

**Wood Finish**

- SW81 WHITE OAK
- SW83 MAPLE
- SW85 WALNUT **+73**
- SW87 OPAQUE BLACK

**3. Finish**

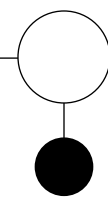

**Standard Powder Coated Metal**

- |                    |                    |
|--------------------|--------------------|
| BL BLUE            | MG MEADOW GREEN    |
| BM BLACK MATTE     | MK MILK            |
| CP CHAMPAGNE       | MS METALLIC SILVER |
| DB DARK BRONZE     | NK NICKEL          |
| DG DARK GRAY       | OC OCHRE           |
| DP DUSTY PINK      | PY PALE YELLOW     |
| DS DARK SAGE       | RO RED ORANGE      |
| LG LIGHT GRAY      | RR RUSTY RED       |
| LL LILAC GRAY      | SB SOFT BLUE       |
| LP LIGHT PISTACHIO | SD SAND            |
| LR LIPSTICK RED    | TC TERRACOTTA      |
| MB MIDNIGHT BLUE   | TP TAUPE           |

# Luna

PLANTER: ENCLOSED

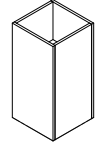
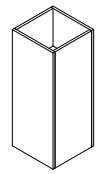
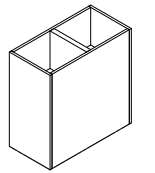
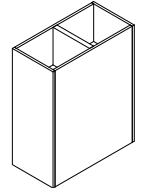
		SERIES	TYPE	HEIGHT	DIMENSIONS	PRICE
Planter, Enclosed, Single, Low Back		LNP	6P1A	LB	15W x 15D x 31H	1,747
Planter, Enclosed, Single, High Back		LNP	6P1A	HB	15W x 15D x 38H	1,996
Planter, Enclosed, Double, Low Back		LNP	6P2A	LB	15W x 30D x 31H	2,523
Planter, Enclosed, Double, High Back		LNP	6P2A	HB	15W x 30D x 38H	2,855

**To Order Select Below**

**1. Series/Type**

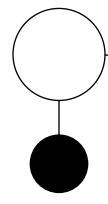

- LUNA PLANTER SINGLE ENCLOSED  
LNP6P1A
- LUNA PLANTER DOUBLE ENCLOSED  
LNP6P2A

**2. Planter Height**

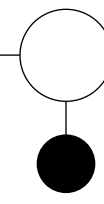

- Planter Height**
- LB LOW BACK
  - HB HIGH BACK

**3. Finish**

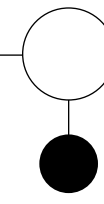

- Finish**
- LM09 BLACK

# Luna

PLANTER: EXPOSED

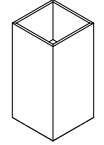
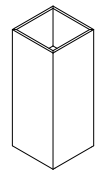
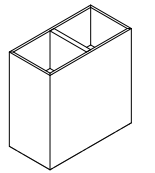
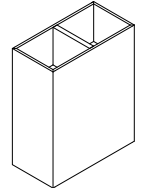
		SERIES	TYPE	HEIGHT	DIMENSIONS	LAMINATE	WOOD VENEER
Planter, Exposed, Single, Low Back		LNP	6P1B	LB	15W x 15D x 31H	2,121	4,190
Planter, Exposed, Single, High Back		LNP	6P1B	HB	15W x 15D x 38H	2,376	4,583
Planter, Exposed, Double, Low Back		LNP	6P2B	LB	15W x 30D x 31H	3,409	5,228
Planter, Exposed, Double, High Back		LNP	6P2B	HB	15W x 30D x 38H	3,741	5,609

**To Order Select Below**

**1. Series/Type**

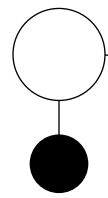

- LUNA PLANTER SINGLE
- LNP6P1B EXPOSED

---

- LUNA PLANTER DOUBLE
- LNP6P2B EXPOSED

**2. Planter Height**

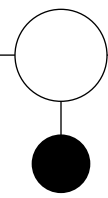

- Planter Height**
- LB LOW BACK
  - HB HIGH BACK

**3. Finish**

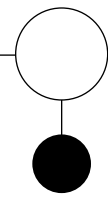

- Finish**
- LM05 DOVE GRAY
  - LM09 BLACK
  - LM14 WALNUT HEIGHTS
  - LM18 CASTLE OAK
  - WV46 NATURAL FLAT CUT WALNUT
  - WV48 NATURAL WHITE OAK