

**stylex**

# Share

PRICE LIST

Effective November 01, 2024

Updated December 16, 2024

# General Information

## STYLEX PRICE LIST

### GENERAL INFORMATION

#### Terms

Net 30 days from date of invoice,  
F. O. B . Delanco, New Jersey.

#### Damaged Shipments

All Stylex products are carefully inspected before they are packed in sturdy cartons designed to satisfy shipping requirements. Stylex is not responsible for damage in shipment. The transportation company assumes responsibility for delivering products to you in good condition when the bill of lading is signed. You protect yourself by refusing shipments showing damage or shortage until transportation company has noted on the delivery sheet the extent of damage or shortage. Concealed damage should be reported to the carrier as soon as discovered, but no later than 5 days after receiving shipment.

#### Return/Restocking Policy

Return shipments will not be accepted unless specifically authorized by Stylex in writing. The Return Authorization number should be clearly marked on the carton. The customer returning Stylex products is responsible for return shipping costs. Merchandise must be returned unused. Returned merchandise is subject to a 35% restocking fee.

#### Special Products

Modifications to standard products will be considered for large runs. Contact factory for price quotations.

#### Design Changes

In keeping with modern manufacturing advances, Stylex reserves the right to incorporate minor modifications and design changes in products without notice.

#### Cancellation/Change Order Policy

Regarding requests for order cancellation and/or order modification, please be advised that no charges will be applied before production, unless inventory has been specifically requisitioned to fulfill your order. Once orders proceed to the production phase, they cannot be altered or canceled under any circumstances. All requests for order cancellations or order changes must be submitted in writing and will only be considered valid upon approval by Stylex.

### WARRANTY

Except as provided below, Stylex warrants exclusively to the original Purchaser of our product that all parts, under normal use and service, will be free from defects in workmanship and material for a period of ten (10) years from the date of purchase. "Normal use and service" means that the product will be used in a typical office environment for 40-45 hours per week.

This warranty is subject to the following limitations, exclusions and provisions:

Limitations involving materials and components:

**Wood components of plywood stacking chairs**  
(such as Brooks and Welcome)  
5 years

#### Upholstery

(including mesh used for Click, F4, Insight, and Zephyr Mesh)  
3 years

#### SAVA Mesh

10 years

#### Pneumatic Cylinders

3 years

#### COM Upholstery

No warranty  
Stylex makes every effort to ensure that the COM Upholstery it approves is suitable for the intended use. Nevertheless, we will not warrant, and assume no responsibility for, the durability or tailoring quality of any COM or COL . If you have any concerns about the ultimate appearance of any covering, please order an upholstered sample.

#### Painted Stack Chair Frames

No Warranty  
We will not warrant the finish of painted stack chair frames against damage from stacking. Please order chrome frames for chairs that will be stacked.

#### Felt Glides

No warranty  
Due to the different surfaces on which felt glides may be used, we cannot warrant their durability over time.

If this product fails during normal use and service within the applicable warranty period (other than through normal wear and tear), please submit a warranty claim at [stylexdesign.com/warranty-claim/](http://stylexdesign.com/warranty-claim/). Quantity, model details, description of issue, and Stylex certified labels are required for submission. PLEASE DO NOT RETURN PARTS OR THE PRODUCT TO STYLEX UNLESS INSTRUCTED TO DO SO BY STYLEX. Stylex will, at its discretion, either repair or replace the defective product or part at no cost. Labor requests must receive approval and will be authorized on a case-by-case basis. We will only reimburse for labor costs directly incurred, excluding any travel-related expenses. Purchaser may be required (at the option of Stylex) to return to Stylex at Purchaser's expense any defective part with all freight or shipping charges prepaid. The foregoing warranty shall be void if the product has been altered or repaired (other than by Stylex). The warranty does not cover damage to the product caused by accident, neglect, misuse, abuse, modification to the product by anyone other than Stylex or damage caused by use of the product for a purpose other than that for which it was designed. This warranty extends only to the original Purchaser of the product.

#### No Other Warranties

This warranty is in lieu of all other warranties, expressed or implied, including, but not limited to, implied warranties of merchantability and fitness for a particular purpose. The rights and remedies provided herein are the exclusive rights and remedies of the original purchaser of the product.

#### No Liability For Damages

In no event shall Stylex or its suppliers be responsible or liable for any special, indirect, consequential, or incidental damages. In no event shall the liability of Stylex exceed the actual purchase price paid to Stylex for the product.

#### Out of Warranty Products

For all products no longer covered by our warranty, please refer to our Design for Durability and Upgradability Policy. Contact your Account Manager if you would like to purchase any replaceable components to further extend the life of any Stylex seating product. This warranty applies to all Stylex products purchased on April 13, 2018, and thereafter.

### PRODUCT TAKE BACK PROGRAM

In order to be good stewards of our products, Stylex offers a pathway towards a Product Take Back Program as a more viable solution to the end of our products' originally intended life.

Stylex supports the sustainable programs of ANEW and offers their added value to our clients through a comprehensive take-back solution for surplus office furniture and materials of any kind, in any condition. ANEW is a 501(c)(3) non-profit organization that exists to provide companies with smart, cost effective alternatives for their surplus furniture and other items with the priority of matching it to non- profits, public agencies and the underserved, within the local community of the project site. Corporate Social Responsibility is raised while the impact on the environment is lowered by diverting products and materials otherwise destined for landfill.

Stylex is proud to offer ANEW to customers dedicated to strengthening their community network by repurposing their furniture, fixtures and architectural materials to those in need. In 2014, Stylex committed to making this relationship a part of our strategic sales strategy. Visit [www.anewfound.org](http://www.anewfound.org) to find out more.

To initiate a Product Take Back strategy through ANEW, contact Stylex Account Management at 800-257-5742.

For other end of life recovery options, please see our Product Disassembly Instructions and End of Life Recovery Options documents available on our website in the resources section of each product in our line.

### FREIGHT PROGRAM

Freight charges will be calculated as a percentage of the net product price and added to the invoice at the time of shipment. The continental United States has been divided into three zones. Please use the map below to determine freight charges for the product's destination. Minimum freight charge is \$250. Please let us know if you will be shipping to a residential address or require inside delivery as this requires an additional fee. Also please note we need to be made aware if a liftgate is required prior to delivery. If any requests are made at the time of delivery, applicable charges will apply.

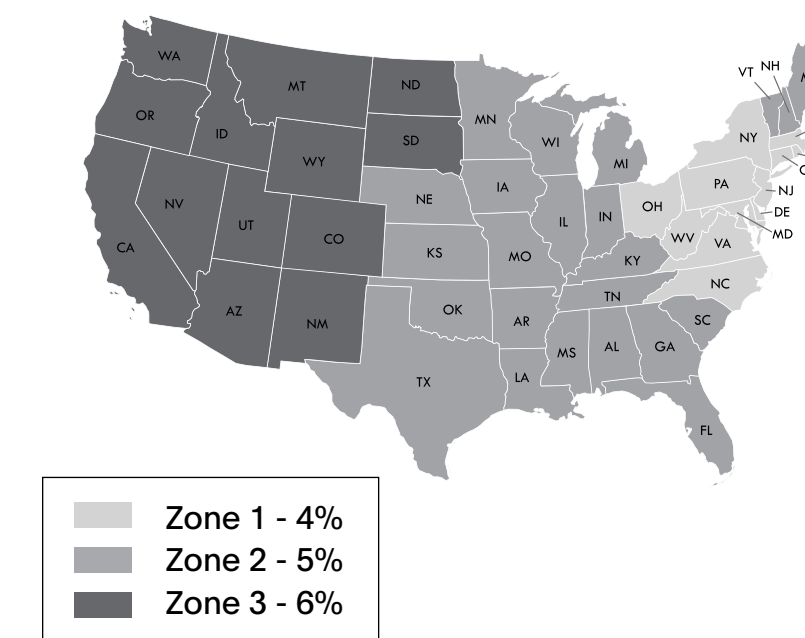

### ZONE 1 - 4%

Connecticut  
Delaware  
New York  
New Jersey  
Maryland  
Massachusetts  
North Carolina  
Ohio  
Pennsylvania  
Rhode Island  
Virginia  
Washington D.C.  
West Virginia

### ZONE 2 - 5%

Alabama  
Arkansas  
Canada, Ontario  
Canada, Quebec  
Florida  
Georgia  
Iowa  
Illinois  
Indiana  
Kansas  
Kentucky  
Louisiana  
Nebraska  
New Hampshire  
Oklahoma  
Maine  
Michigan  
Minnesota  
Missouri  
Mississippi  
South Carolina  
Tennessee  
Texas  
Vermont  
Wisconsin

### ZONE 3 - 6%

Arizona  
California  
Colorado  
Idaho  
Montana  
Nevada  
New Mexico  
North Dakota  
Oregon  
South Dakota  
Utah  
Washington  
Wyoming

**Quote Per Project**  
Alaska  
Hawaii  
Canada  
(outside Ontario & Quebec)  
Mexico

# General Information

## STYLEX PRICE LIST

### TEXTILE PARTNERS & APPROVALS

#### Textile Partners

To customize your furniture performance needs and design vision, Stylex offers a wide selection of in-graded leathers and textiles from Grades A through Y. We've partnered with leading manufacturers on the options, focusing on color, price, durability, and construction. To view our partners and explore our digital carded program with broadly approved textiles, visit [this page](#). We stand by these textiles: They're tried and tested, and will effortlessly fit into any design aesthetic.

#### Textile Approvals

All textiles must be approved for the product you are specifying. For the related approved textile lists, visit [this page](#).

### CAL 117 AND 133 COMPLIANCE

#### CAL 117-2013

CAL 117-2013 compliance is a requirement for all textiles applied on our seating products. All Stylex seating products meet this standard.

#### CAL 133

Most Stylex seating can be ordered to meet the requirements of CAL 133. When ordering, simply specify "CAL 133 compliance required". The upcharge for this option is \$54 list per yard. Please refer to the COM yardage of each model to determine the number of yards required. We do frequently require full-scale burn tests in order to certify CAL 133 before an order will be accepted. Such burn tests may increase normal lead times and do carry additional charges. Please contact your Stylex account manager for details.

### CUSTOMER'S OWN MATERIAL/LEATHER

Customer's own material (COM) and customer's own leather (COL) will generally be upholstered at the price designated in each product's price list. Please be advised, however, that we specifically reserve the right to charge a higher price when we determine that special circumstances, such as unusual repeats or challenging materials, present themselves. All orders for custom coverings must be approved by Stylex before they will be accepted for production. To submit proposed textile for approval, please use the COM form [here](#).

#### Special Note:

We assume no responsibility for the durability or tailoring quality of any COM or COL. Directional covers in particular may not meet your satisfaction due to the design of certain products. Please be advised that COM and COL orders are not subject to return. If you have doubts about the ultimate appearance of certain coverings, please order a sample done with that specific COM or COL. In addition, while we inspect fabrics for mill imperfections, some are difficult to recognize. We cannot be responsible for defects, color inaccuracies, dye lot variations, or other flaws.

Under no circumstances will we be responsible for COM shortages, flaws, or other such problems. Finally, it is not our responsibility to police the receipt of COM's in order to meet delivery deadlines, and we assume our customers are aware of any undue delay in the shipment of their COM fabrics.

#### COM fabric and COL leather should be sent prepaid to: Stylex

**Attn: COM/COL - [Your Stylex PO #]  
740 Coopertown Road  
Delanco, NJ 08075**

**All COM/COL sent to Stylex must be accompanied with a packing list which indicates the dealers' name, Stylex corresponding PO number, sales order number, COM/COL supplier name, textile pattern, colorway and shipped quantity. Stylex requires COM to be sent in as continuous yardage in the same dielot.**

Yardage requirements shown in the price list are based on non-directional goods of 54" width. Fabrics less than 54" wide or those requiring matching (stripes, prints, or large patterned designs) call for additional yardage. We will be happy to supply yardage requirements for large quantities where economies may be realized.

#### Add the following yardage for stripes, plaids, or patterns with repeats:

Fabric Width	Plain Fabric	2-14" Repeat	15-24" Repeat	25-27" Repeat	28-36" Repeat
54"	0%	10%	15%	20%	25%
50"	10%	20%	25%	30%	35%
48"	15%	25%	30%	35%	40%
45"	40%	50%	55%	60%	65%
36"	50%	60%	65%	70%	75%

### COM/COL FORM

To avoid delay in processing COM orders we request that you submit a sample of your COM textile stapled to this form which can be downloaded [here](#). If a textile has a stripe or design, the size of the repeat should be indicated. Please indicate the textile supplier's name, textile number, and color. Also indicate the Stylex product on which the textile will be used. If a certain direction of application is required, please ensure that information is communicated directly to your Stylex account manager.

The fabric supplier must indicate on his shipping labels the dealer name and purchase order number as well as the Stylex model number.

#### Please Note:

No order may be entered into production or have a shipping date assigned until all related COM is received at the factory.



### CENTER OF STRIPE OR DESIGN

TOP OF CHAIR	TOP OF CHAIR
--------------	--------------

1. Size of Repeat

2. Textile Supplier

3. Textile Number

4. Color

5. Stylex Product

**Share**

# Contents

<hr/>		<hr/>		<hr/>	
COLORS, MATERIALS, AND FINISHES	5	CHAIR	11	END CAP: SINGLE NARROW	46
STATEMENT OF LINE	6	CHAIR: CORNER	20	KNEE WALL	51
OPTIONS AND ACCESSORIES	7	CHAIR: CURVED	26	ARM	53
DIMENSIONS	8	BENCH	38	ROUND OTTOMAN	54
IDEA STARTERS	9	BENCH: CORNER	41	ACCESSORIES	55
HOW TO ORDER	10	BENCH: CURVED	42		
<hr/>		<hr/>		<hr/>	

CLICK THE TITLES ABOVE TO NAVIGATE THROUGH THE DOCUMENT  
PRODUCT HEADERS ON SUBSEQUENT PAGES LINK BACK TO THIS PAGE

# Share

COLORS, MATERIALS, AND FINISHES

---

## POWDER COATED PAINTED METAL

---

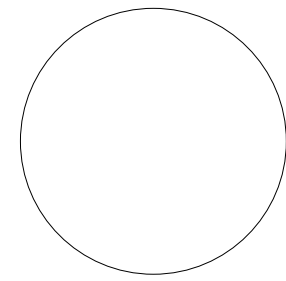

MILK  
(MK)

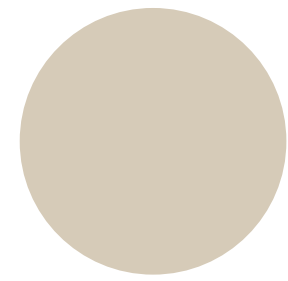

SAND  
(SD)

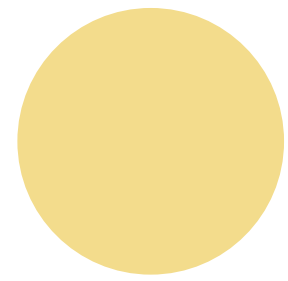

PALE YELLOW  
(PY)

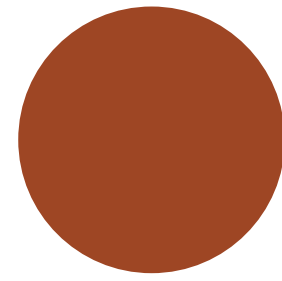

TERRACOTTA  
(TC)

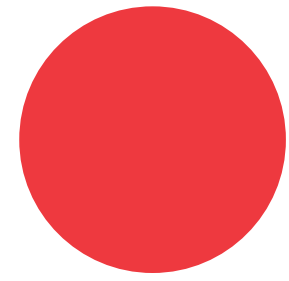

LIPSTICK RED  
(LR)

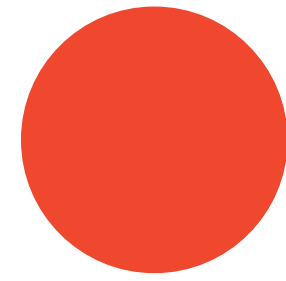

RED ORANGE  
(RO)

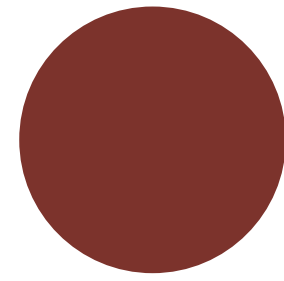

RUSTY RED  
(RR)

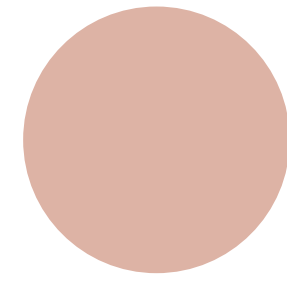

DUSTY PINK  
(DP)



LIGHT PISTACHIO  
(LP)

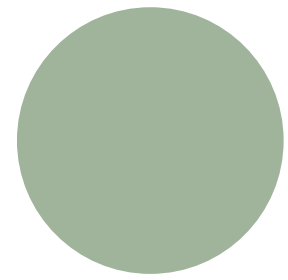

MEADOW GREEN  
(MG)

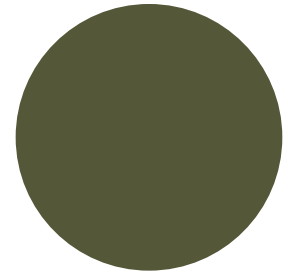

DARK SAGE  
(DS)

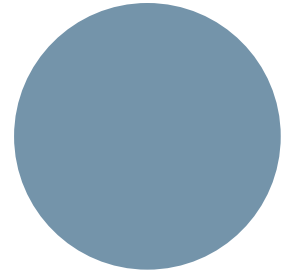

SOFT BLUE  
(SB)

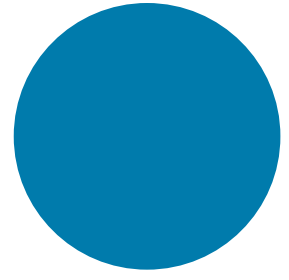

BLUE  
(BL)

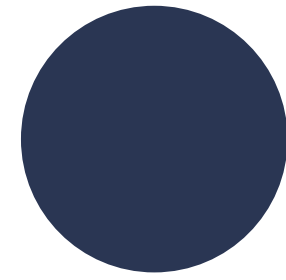

MIDNIGHT BLUE  
(MB)



LILAC GRAY  
(LL)

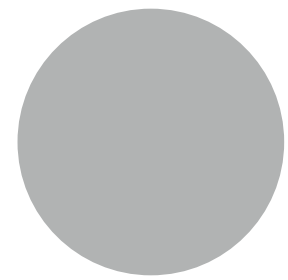

LIGHT GRAY  
(LG)



CHAMPAGNE  
(CP)

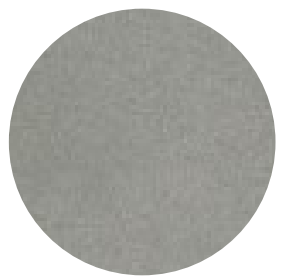

METALLIC SILVER  
(MS)



NICKEL  
(NK)

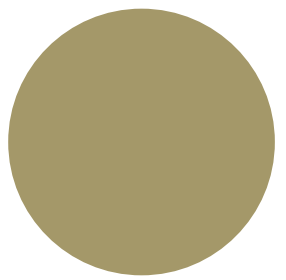

OCHRE  
(OC)

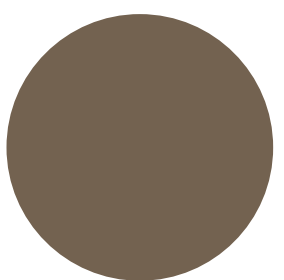

TAUPE  
(TP)



DARK BRONZE  
(DB)

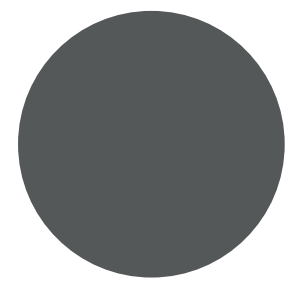

DARK GRAY  
(DG)

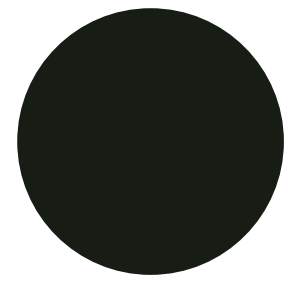

BLACK MATTE  
(BM)

---

## POLISHED METAL LEG FINISH

---

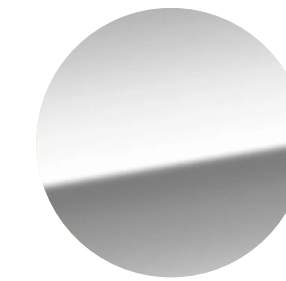

POLISHED  
ALUMINUM  
(AL)

---

## WOOD LEG FINISH

---



NATURAL MAPLE  
(83)



WHITE OAK  
(81)



WALNUT  
(85)

# Share

## SPECIFICATION GUIDE: STATEMENT OF LINE

OVERVIEW						
<b>Chairs</b> Lounge Height Task Height	Single-Seater	Two-Seater	Three-Seater	120° Corner	90° Corner	
<b>Banquette Chairs</b> Task Height	Single-Seater	Two-Seater	Three-Seater	120° Corner	90° Corner	
<b>Benches</b> Lounge Height Task Height	Single-Seater	Two-Seater	Three-Seater	120° Corner	Outside Corner Bench	
<b>End Cap</b> Lounge Height Task Height	Single Narrow	Double Narrow	Double Narrow +	Double Wide	Double Wide +	
<b>Knee Walls - 9"W</b> Low Knee Wall / Armrest Height High Knee Wall / Seat Back Height	Low/Low+	High/High+	<b>Arms - 4"W</b> Armrest Height	24"H*	26"H*	* Armrest surface is 24" above the floor ** Armrest surface is 26" above the floor
<b>Curved Chairs</b> Lounge Height Task Height	30° Outside	30° Inside	60° Outside	60° Inside	90° Outside	90° Inside
<b>Curved Benches</b> Lounge Height Task Height	30° Inside	60° Inside	90° Inside	<b>Round Ottomam</b> Lounge Height Task Height		

## GENERAL INFORMATION

**Design**  
Stylex

**Ganging**  
All individual units may be connected to one another with the use of a simple draw latch system.

**Legs**  
Share is available with 3 leg options: corner, round, and wood. Angle and round legs are cast aluminum and may be polished or painted. The wood legs come in three standard finishes and are also available in custom finishes. Adjustable glides are standard.

**Power In Knee Walls**  
Power receptacle offers one-touch accessibility to one USB-A port, one USB-C port, and a standard, grounded 3-prong electrical outlet.

**Power In Chairs And Benches**  
Power receptacle offers three exposed power ports: one USB-A port, one USB-C port, and a standard, grounded 3-prong electrical outlet.

**Testing**  
Manufactured to comply with:  
ANSI/BIFMA X5.4 Public and Lounge Seating Standard

**Certifications**  
Greenguard Gold  
LEVEL® 2

# Share

## SPECIFICATION GUIDE: OPTIONS AND ACCESSORIES

### OVERVIEW

#### Chairs Power Port Options

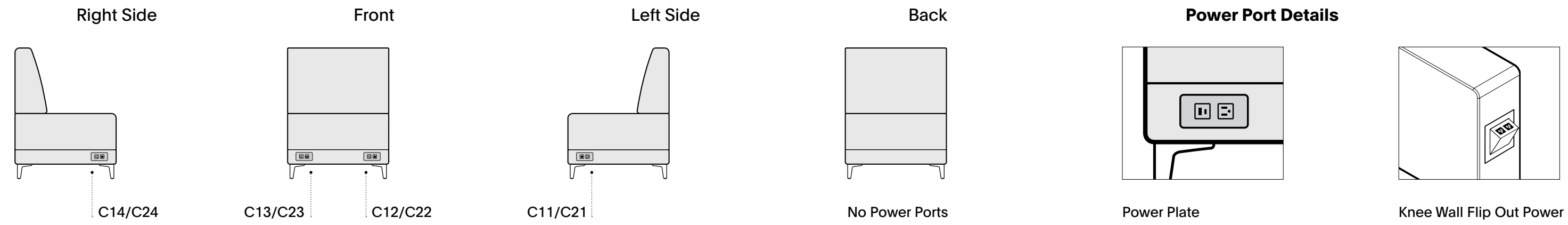

#### Benches Power Port Options

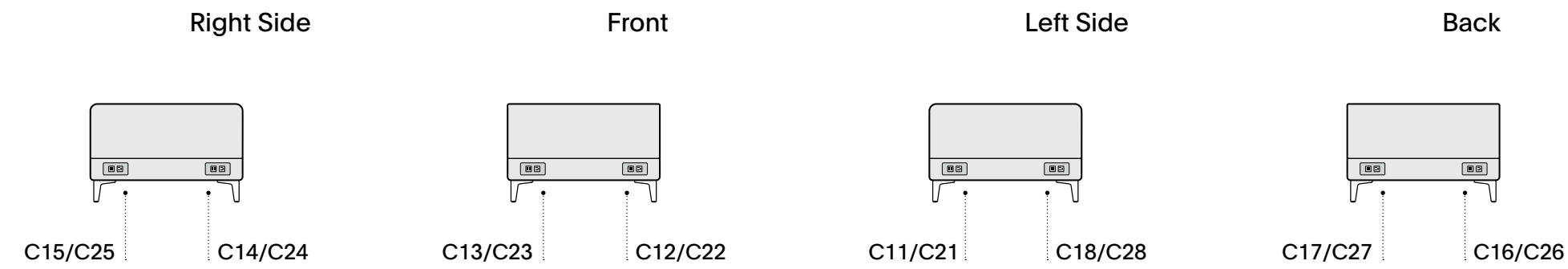

#### Accessories

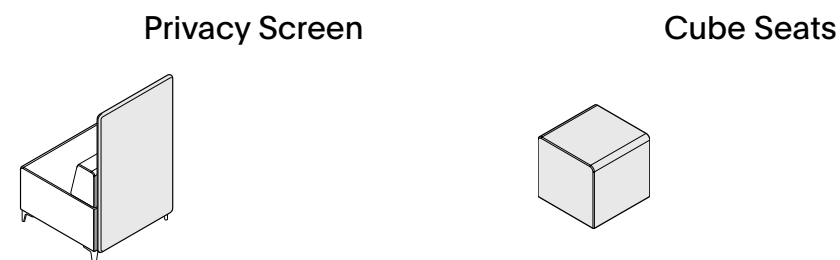

#### Leg Options

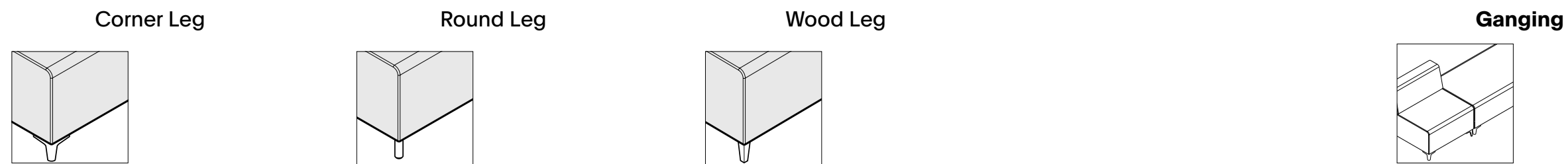

#### Cover Options

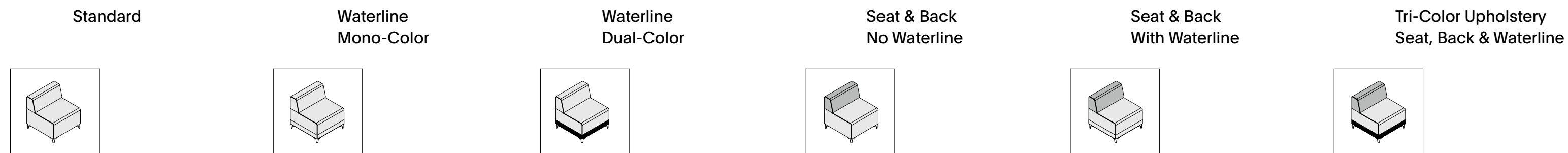

### GENERAL INFORMATION

#### In-Seat Power Ports With 10' Or 20' Cord

##### Power Port Cord Length

C1× has a 10' power cord. C2× has a 20' power cord

##### Power Port Location

The power port location is determined by its last digit.

##### Examples:

- A C14 power port has a 10' power cord and is located on the right side of a chair or the right forward position of a bench.
- A C21 power port has a 20' power cord and is located on the left side of a chair or the left forward position of a bench.

##### Note:

Curved units may only have power ports located on the sides, not on the front or back. Power ports are not available on ottomans. Multiple power ports may be ordered per unit. The pricing shown is for each power port ordered.

##### In-Seat Power Port Finish

Power ports can be finished in any standard powder coat available.

##### Power In Chairs And Benches

Power receptacle offers three exposed power ports: one USB-A port, one USB-C port, and a standard, grounded 3-prong electrical outlet.

##### Power In Knee Walls

Power receptacle offers one-touch accessibility to one USB-A port, one USB-C port, and a standard, grounded 3-prong electrical outlet.

##### Ganging

All individual units may be connected to one another with the use of a simple draw latch system.

##### Legs

Share is available with 3 leg options: angle, round, and wood. Angle and round legs are cast aluminum and may be polished or painted. The wood legs come in three standard finishes and are also available in custom finishes. Adjustable glides are standard.

# Share

## SPECIFICATION GUIDE: DIMENSIONS

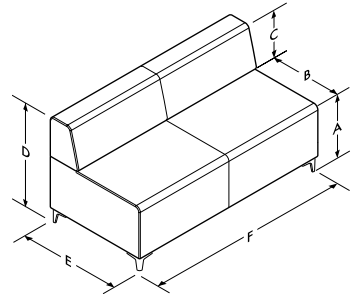
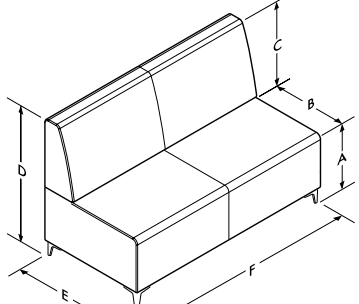
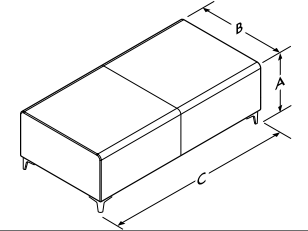
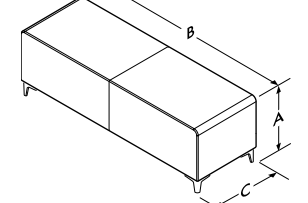
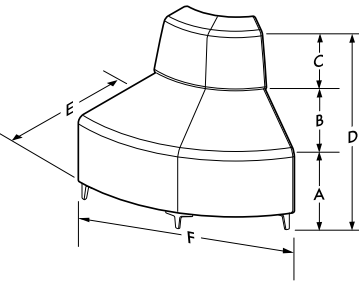
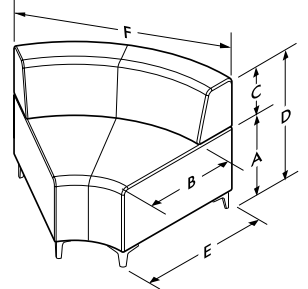
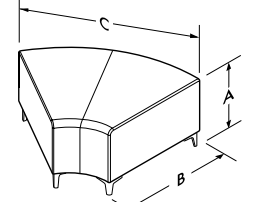
OVERVIEW	TASK HEIGHT			LOUNGE HEIGHT		
<b>Chairs</b> A. Seat Height B. Seat Depth C. Back Height D. Overall Height E. Overall Depth F. Overall Width 	<b>Single-Seater</b> A. 18" B. 19" C. 11" D. 29" E. 28" F. 28"	<b>Two-Seater</b> A. 18" B. 19" C. 11" D. 29" E. 28" F. 56"	<b>Three-Seater</b> A. 18" B. 19" C. 11" D. 29" E. 28" F. 84"	<b>Single-Seater</b> A. 16" B. 19" C. 13" D. 29" E. 28" F. 28"	<b>Two-Seater</b> A. 16" B. 19" C. 13" D. 29" E. 28" F. 56"	<b>Three-Seater</b> A. 16" B. 19" C. 13" D. 29" E. 28" F. 84"
<b>Banquette Chairs</b> A. Seat Height B. Seat Depth C. Back Height D. Overall Height E. Overall Depth F. Overall Width 	<b>Single-Seater</b> A. 18" B. 19" C. 18" D. 36" E. 28" F. 28"	<b>Two-Seater</b> A. 18" B. 19" C. 18" D. 36" E. 28" F. 56"	<b>Three-Seater</b> A. 18" B. 19" C. 18" D. 36" E. 28" F. 84"	-	-	-
<b>Benches</b> A. Overall/Seat Height B. Seat Depth C. Overall Width 	<b>Single-Seater</b> A. 18" B. 28" C. 28"	<b>Two-Seater</b> A. 18" B. 28" C. 56"	<b>Three-Seater</b> A. 18" B. 28" C. 84"	<b>Single-Seater</b> A. 16" B. 28" C. 28"	<b>Two-Seater</b> A. 16" B. 28" C. 56"	<b>Three-Seater</b> A. 16" B. 28" C. 84"
<b>End Caps - Narrow</b> A. Height B. Depth C. Width 	<b>Single</b> A. 18" B. 28" C. 19"	<b>Double</b> A. 18" B. 56" C. 19"	<b>Double +</b> A. 18" B. 57" C. 19"	<b>Single</b> A. 16" B. 28" C. 19"	<b>Double</b> A. 16" B. 56" C. 19"	<b>Double +</b> A. 16" B. 57" C. 19"
<b>Curved Outside Chairs</b> A. Seat Height B. Seat Depth C. Back Height D. Overall Height E. Overall Depth F. Overall Width 	<b>30°</b> A. 18" B. 19" C. 11" D. 29" E. 28" F. 35"	<b>60°</b> A. 18" B. 19" C. 11" D. 29" E. 28" F. 38.875"	<b>90°</b> A. 18" B. 19" C. 11" D. 29" E. 28" F. 56.25"	<b>30°</b> A. 16" B. 19" C. 13" D. 29" E. 28" F. 35"	<b>60°</b> A. 16" B. 19" C. 13" D. 29" E. 28" F. 38.875"	<b>90°</b> A. 16" B. 19" C. 13" D. 29" E. 28" F. 56.25"
<b>Curved Inside Chairs</b> A. Seat Height B. Seat Depth C. Back Height D. Overall Height E. Overall Depth F. Overall Width 	<b>30°</b> A. 18" B. 19" C. 11" D. 29" E. 28" F. 35"	<b>60°</b> A. 18" B. 19" C. 11" D. 29" E. 28" F. 39.75"	<b>90°</b> A. 18" B. 19" C. 11" D. 29" E. 28" F. 56.25"	<b>30°</b> A. 16" B. 19" C. 13" D. 29" E. 28" F. 35"	<b>60°</b> A. 16" B. 19" C. 13" D. 29" E. 28" F. 39.75"	<b>90°</b> A. 16" B. 19" C. 13" D. 29" E. 28" F. 56.25"
<b>Curved Benches</b> A. Height B. Depth C. Width 	<b>30°</b> A. 18" B. 28" C. 35"	<b>60°</b> A. 18" B. 28" C. 39.75"	<b>90°</b> A. 18" B. 28" C. 56.25"	<b>30°</b> A. 16" B. 28" C. 35"	<b>60°</b> A. 16" B. 28" C. 39.75"	<b>90°</b> A. 16" B. 28" C. 56.25"

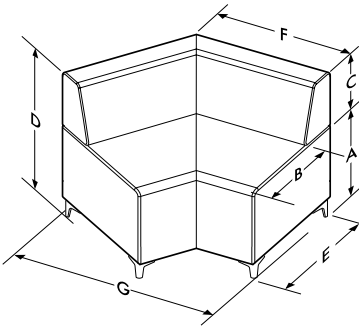
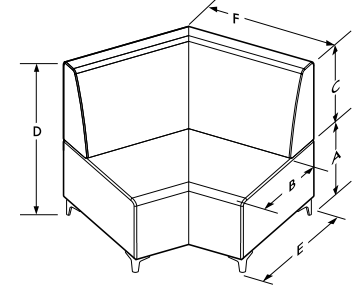
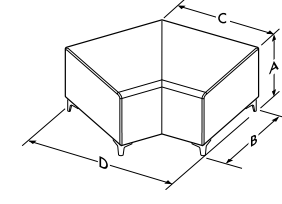
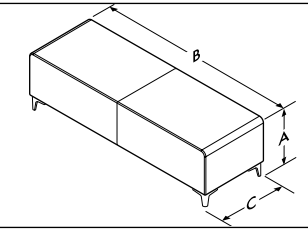
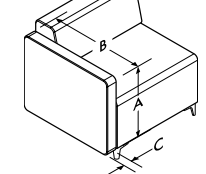
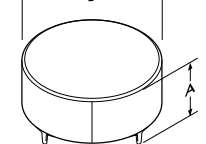
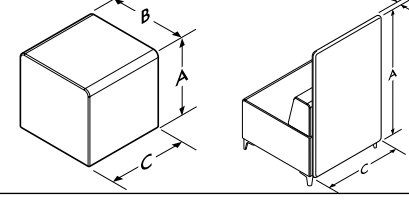
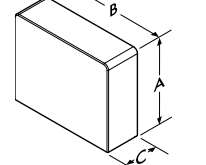
OVERVIEW	TASK HEIGHT		LOUNGE HEIGHT		
<b>Corners</b> A. Seat Height B. Seat Depth To Back C. Back Height D. Overall Height E. Overall Seat Depth F. Back Width G. Overall Width 	<b>120°</b> A. 18" B. 19" C. 11" D. 29" E. 28" F. 28" G. 42.5"	<b>90°</b> A. 18" B. 19" C. 11" D. 29" E. 28" F. 56" G. 42.5"	<b>120°</b> A. 16" B. 19" C. 13" D. 29" E. 28" F. 28" G. 42.5"	<b>90°</b> A. 16" B. 19" C. 13" D. 29" E. 28" F. 56" G. 42.5"	
<b>Banquette Corners</b> A. Seat Height B. Seat Depth To Back C. Back Height D. Overall Height E. Overall Seat Depth F. Back Width G. Overall Width 	<b>120°</b> A. 18" B. 19" C. 18" D. 36" E. 28" F. 28" G. 42.5"	<b>90°</b> A. 18" B. 19" C. 18" D. 36" E. 28" F. 56" G. 42.5"	-	-	
<b>Corner Benches</b> A. Overall/Seat Height B. Seat Depth C. Seat Width D. Overall Width 	<b>120°</b> A. 18" B. 28" C. 28" D. 42.5"	<b>Outside Corner</b> A. 18" B. 28" C. 28" D. 28"	<b>120°</b> A. 16" B. 28" C. 28" D. 42.5"	<b>Outside Corner</b> A. 18" B. 28" C. 28" D. 28"	
<b>End Caps - Wide</b> A. Height B. Depth C. Width 	<b>Double</b> A. 16" B. 56" C. 28"	<b>Double +</b> A. 16" B. 57" C. 28"	<b>Double</b> A. 16" B. 56" C. 28"	<b>Double +</b> A. 16" B. 57" C. 28"	
<b>Arms</b> A. Height B. Depth C. Width 	<b>26"</b> A. 22" B. 28" C. 4"	-	<b>24"</b> A. 20" B. 28" C. 4"	-	
<b>Round Ottoman</b> A. Overall/Seat Height B. Overall Depth 	A. 18" B. 36"	-	A. 16" B. 36"	-	
<b>Accessories</b> A. Height B. Depth C. Width 	<b>Cube Seat</b> A. 18" B. 19" C. 19"	<b>Privacy Screen</b> A. 43" B. 1.25" C. 27"	<b>Cube Seat</b> A. 16" B. 19" C. 19"	-	
<b>Knee Wells</b> A. Height B. Depth C. Width 	<b>Low</b> A. 24" B. 28" C. 9"	<b>Low</b> A. 24" B. 28.5" C. 9"	<b>High</b> A. 29" B. 28" C. 9"	<b>High</b> A. 29" B. 28.5" C. 9"	-



# Share

SPECIFICATION GUIDE: IDEA STARTERS

---

## IDEA STARTERS

---

**Idea Starter 1**



**Idea Starter 2**



**Idea Starter 3**



**Idea Starter 4**



**Idea Starter 5**



**Idea Starter 6**



---

## SPECIFICATION TOOLS

---

### **Idea Starters Online and in CET**

At Stylex, we have a constant eye towards making our products easy to specify. Our Design Application team is working on layouts every day, so we have built an online library of the most requested layouts, with all the accompanying information, files, and pricing. We believe these will make our products easier to specify, and in turn help kick start your project. You can also find these in CET; please check out our 'Idea Starters' tab on for the easiest way to drag-and-drop right into your layout. Visit [Stylexdesign.com/idea-starters](https://stylexdesign.com/idea-starters) to get started.

# Share

SPECIFICATION GUIDE: HOW TO ORDER

## MODEL CODE BREAKDOWN - SEATING

Sample Model Code: SH1116L381C11YL1COM



**SH**

**1116**

**L381**

**C11YL**

**U1**

**COM**

1. Series	2. Series/Type/Seat	3. Leg	5. Options	6. Upholstery Style	7. Upholstery		
<p><b>Series</b></p> <p>SH SHARE</p>	<p><b>Series/Type/Seat</b></p> <p>1116 SINGLE SEATER CHAIR - LOUNGE HEIGHT            1118 SINGLE SEATER CHAIR - TASK HEIGHT            7118 SINGLE SEATER BANQUETTE - TASK HEIGHT            1126 TWO-SEATER CHAIR - LOUNGE HEIGHT            1128 TWO-SEATER CHAIR - TASK HEIGHT            7128 TWO-SEATER BANQUETTE - TASK HEIGHT            1136 THREE-SEATER CHAIR - LOUNGE HEIGHT            1138 THREE-SEATER CHAIR - TASK HEIGHT            7138 THREE-SEATER BANQUETTE - TASK HEIGHT            1226 90DEG CHAIR - LOUNGE HEIGHT            1228 90DEG CHAIR - TASK HEIGHT            7228 90DEG BANQUETTE - TASK HEIGHT            1246 120DEG CHAIR - LOUNGE HEIGHT            1248 120DEG CHAIR - TASK HEIGHT            7248 120DEG BANQUETTE - TASK HEIGHT            1556 OUT 30DEG CURVED CHAIR - LOUNGE HEIGHT            1558 OUT 30DEG CURVED CHAIR - TASK HEIGHT            1566 OUT 60DEG CURVED CHAIR - LOUNGE HEIGHT            1568 OUT 60DEG CURVED CHAIR - TASK HEIGHT            1576 OUT 90DEG CURVED CHAIR - LOUNGE HEIGHT            1578 OUT 90DEG CURVED CHAIR - TASK HEIGHT            1456 IN 30DEG CURVED CHAIR - LOUNGE HEIGHT            1458 IN 30DEG CURVED CHAIR - TASK HEIGHT            1466 IN 60DEG CURVED CHAIR - LOUNGE HEIGHT            1468 IN 60DEG CURVED CHAIR - TASK HEIGHT            1476 IN 90DEG CURVED CHAIR - LOUNGE HEIGHT            1478 IN 90DEG CURVED CHAIR - TASK HEIGHT            0116 SINGE SEATER BENCH - LOUNGE HEIGHT            0118 SINGLE SEATER BENCH - TASK HEIGHT            0126 TWO SEATER BENCH - LOUNGE HEIGHT            0128 TWO SEATER BENCH - TASK HEIGHT            0136 THREE SEATER BENCH - LOUNGE HEIGHT            0138 THREE SEATER BENCH - TASK HEIGHT</p>	<p>0246 120DEG BENCH - LOUNGE HEIGHT            0248 120DEG BENCH - TASK HEIGHT            0456 30DEG CURVED BENCH - LOUNGE HEIGHT            0458 30DEG CURVED BENCH - TASK HEIGHT            0466 60DEG CURVED BENCH - LOUNGE HEIGHT            0468 60DEG CURVED BENCH - TASK HEIGHT            0476 90DEG CURVED BENCH - LOUNGE HEIGHT            0478 90DEG CURVED BENCH - TASK HEIGHT            0486 ROUND OTTOMAN LOUNGE            0488 ROUND OTTOMAN TASK            0306 SINGLE NARROW END CAP - LOUNGE HEIGHT            0308 SINGLE NARROW END CAP - TASK HEIGHT            0316 DOUBLE NARROW END CAP - LOUNGE HEIGHT            0318 DOUBLE NARROW END CAP - TASK HEIGHT            0326 DOUBLE NARROW END CAP+ - LOUNGE HEIGHT            0328 DOUBLE NARROW END CAP+ - TASK HEIGHT            0346 DOUBLE WIDE END CAP - LOUNGE HEIGHT            0348 DOUBLE WIDE END CAP - TASK HEIGHT            0356 DOUBLE WIDE END CAP+ - LOUNGE HEIGHT            0358 DOUBLE WIDE END CAP+ - TASK HEIGHT            0616 OUTSIDE 90 CORNER BENCH LOUNGE HEIGHT            0618 OUTSIDE 90 CORNER BENCH TASK HEIGHT            241 24H LOW KNEE WALL            242 24H LOW KNEE WALL+            546 24H LOUNGE CHAIR ARM            548 24H TASK CHAIR ARM            568 26H TASK CHAIR ARM            291 29H HIGH KNEE WALL            292 29H HIGH KNEE WALL+            4106 CUBE - LOUNGE HEIGHT            4108 CUBE - TASK HEIGHT            3100 PRIVACY SCREEN</p>	<p><b>Leg</b></p> <p>L1 CORNER LEG            L2 ROUND LEG            L3 WOOD LEG</p> <p><b>Leg Finish</b></p> <p><b>Standard Powder Coat</b></p> <p>BL BLUE            BM BLACK MATTE            CP CHAMPAGNE            DB DARK BRONZE            DG DARK GRAY            DP DUSTY PINK            DS DARK SAGE            LG LIGHT GRAY            LL LILAC GRAY            LP LIGHT PISTACHIO            LR LIPSTICK RED            MB MIDNIGHT BLUE            MG MEADOW GREEN            MK MILK            MS METALLIC SILVER            NK NICKEL            OC OCHRE            PY PALE YELLOW            RO RED ORANGE            RE            RR RUSTY RED            SB SOFT BLUE            SD SAND            TC TERRACOTTA            TP TAUPE</p> <p><b>Polished Metal</b></p> <p>AL POLISHED ALUMINUM</p> <p><b>Wood</b></p> <p>81 WHITE OAK            83 NATURAL MAPLE            85 WALNUT            09 CUSTOM COLOR</p>	<p><b>Ganging</b></p> <p>SG GANGING</p> <p><b>Power Cord Length</b></p> <p>C1 10' CABLE            C2 20' CABLE</p> <p><b>Power Port Position</b></p> <p>1 POSITION 1            2 POSITION 2            3 POSITION 3            4 POSITION 4            5 POSITION 5            6 POSITION 6            7 POSITION 7            8 POSITION 8</p> <p><b>Knee Wall</b></p> <p><b>Flip Out Power</b></p> <p>P10 9' CABLE            P20 19' CABLE</p>	<p><b>Power Port Color</b></p> <p><b>Standard Powder Coat</b></p> <p>BL BLUE            BM BLACK MATTE            CP CHAMPAGNE            DB DARK BRONZE            DG DARK GRAY            DP DUSTY PINK            DS DARK SAGE            LG LIGHT GRAY            LL LILAC GRAY            LP LIGHT PISTACHIO            LR LIPSTICK RED            MB MIDNIGHT BLUE            MG MEADOW GREEN            MK MILK            MS METALLIC SILVER            NK NICKEL            OC OCHRE            PY PALE YELLOW            RO RED ORANGE            RR RUSTY RED            SB SOFT BLUE            SD SAND            TC TERRACOTTA            TP TAUPE</p>	<p><b>Dual Upholstery</b></p> <p>U1 MONO-COLOR WATERLINE            U2 DUAL-COLOR WATERLINE            U3 SEAT &amp; BACK, NO WATERLINE            U4 SEAT &amp; BACK, WITH WATERLINE            U8 TRI-COLOR - SEAT, BACK &amp; WATERLINE</p>	<p><b>Textile Grades</b></p> <p>COM CUSTOMER'S OWN MATERIAL            A GRADE A            B GRADE B            C GRADE C            D GRADE D            E GRADE E            F GRADE F            G GRADE G            H GRADE H            I GRADE I            J GRADE J            K GRADE K            L GRADE L            M GRADE M</p> <p>Note: Select highest grade in the case of dual upholstery</p>

# Share

CHAIR: SINGLE-SEATER, LOUNGE HEIGHT

## Textile Upholstery Grades

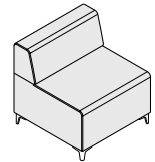
TITLE	SERIES	TYPE	SEAT	UPH	DIMENSIONS	YDG	COM	A	B	C	D	E	F	G	H	I	J	K	L	M	
 <b>Chair, Single-Seater, Lounge Height</b>	Standard Upholstery	SH	11	16	28W x 28D x 29H	2.8	2,227	2,462	2,592	2,720	2,846	2,976	3,119	3,262	3,429	3,643	3,901	4,009	4,254	4,458	
	Mono-Color Waterline	SH	11	16	U1	28W x 28D x 29H	2.8	2,417	2,655	2,783	2,912	3,040	3,169	3,312	3,454	3,620	3,836	4,093	4,200	4,444	4,649
	Dual-Color Waterline	SH	11	16	U2	28W x 28D x 29H	2.5 above Waterline 0.8 below Waterline	2,417	2,696	2,846	3,004	3,152	3,305	3,469	3,638	3,836	4,089	4,392	4,518	4,806	5,047
	No Waterline Back & Seat	SH	11	16	U3	28W x 28D x 29H	1.2 Back 1.6 Seat	2,227	2,462	2,592	2,720	2,846	2,976	3,119	3,262	3,429	3,643	3,901	4,009	4,254	4,458
	Waterline Back & Seat	SH	11	16	U4	28W x 28D x 29H	1.2 Back 1.6 Seat/below Waterline	2,417	2,655	2,783	2,912	3,040	3,169	3,312	3,454	3,620	3,836	4,093	4,200	4,444	4,649
	Triple-Back & Seat & Waterline	SH	11	16	U8	28W x 28D x 29H	0.8 below Waterline 1.2 Back 1.3 Seat/above Waterline	2,417	2,696	2,846	3,004	3,152	3,305	3,469	3,638	3,836	4,089	4,392	4,518	4,806	5,047

### To Order Select Below

#### 1. Series/Type/Seat

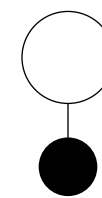

SH1116

**Share**  
Chair, Single-Seater,  
Lounge Height

#### 2. Leg

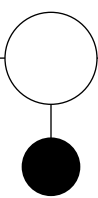

##### Leg

- L1 CORNER LEG, ADJ. PLASTIC GLIDES
- L2 ROUND LEG, ADJ. PLASTIC GLIDES
- L3 WOOD LEG

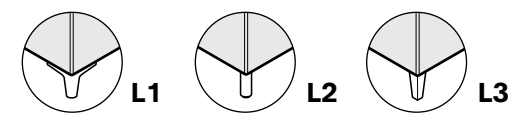

##### Mobility

The round leg glide has a larger diameter (1") than the corner leg for easier sliding on low pile carpet. Stylex is not responsible for damage to carpeting or floors.

#### 3. Leg Finish

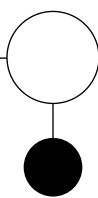

##### Standard Powder Coated Metal

- BL BLUE
- BM BLACK MATTE
- CP CHAMPAGNE
- DB DARK BRONZE
- DG DARK GRAY
- DP DUSTY PINK
- DS DARK SAGE
- LG LIGHT GRAY
- LL LILAC GRAY
- LP LIGHT PISTACHIO
- LR LIPSTICK RED
- MB MIDNIGHT BLUE

- MG MEADOW GREEN
- MK MILK
- MS METALLIC SILVER
- NK NICKEL
- OC OCHRE
- PY PALE YELLOW
- RO RED ORANGE
- RR RUSTY RED
- SB SOFT BLUE
- SD SAND
- TC TERRACOTTA
- TP TAUPE

#### 4. Options

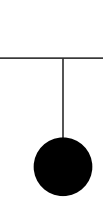

##### Polished Aluminum

- AL POLISHED ALUMINUM

##### Wood Finish +224

- 81 WHITE OAK
- 83 NATURAL MAPLE
- 85 WALNUT

##### Custom Color Match

- 09 CUSTOM COLOR

Per order per color - 20 chair minimum.  
Contact customer service for details.

#### 5. Upholstery Style

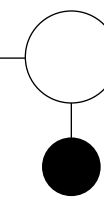

##### Ganging

- SG GANGING +53

Used to connect chairs to adjacent chairs or benches.

##### Power

- IN-SEAT POWER  
C1X PORT W/10' CORD +452
- IN-SEAT POWER  
C2X PORT W/20' CORD +485

See [page 7](#) for power port spec info.

##### Power Port Finish

Power ports can be finished in any standard powder coat available.

#### 6. Upholstery

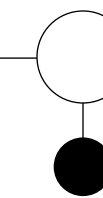

##### Upholstery Style

- U1 MONO-COLOR WATERLINE
- U2 DUAL-COLOR WATERLINE
- U3 SEAT & BACK, NO WATERLINE
- U4 SEAT & BACK, WITH WATERLINE
- U8 TRI-COLOR - SEAT, BACK & WATERLINE

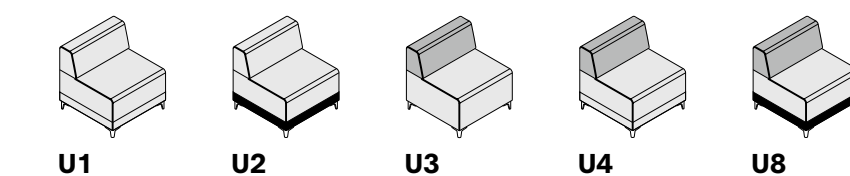

When pricing models with more than one fabric, the higher grade fabric will determine the overall grade of the specific product.

##### Upholstery

See [general information section](#) for details on textile program and COM/COL information.

Share will develop comfort wrinkles over time. The extent of these wrinkles is determined by the fabric specified.

# Share

CHAIR: SINGLE-SEATER, TASK HEIGHT

## Textile Upholstery Grades

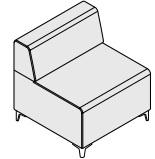
TITLE	SERIES	TYPE	SEAT	UPH	DIMENSIONS	YDG	COM	A	B	C	D	E	F	G	H	I	J	K	L	M	
 <p><b>Chair, Single-Seater, Task Height</b></p>	Standard Upholstery	SH	11	18	28W x 28D x 29H	2.8	2,227	2,462	2,592	2,720	2,846	2,976	3,119	3,262	3,429	3,643	3,901	4,009	4,254	4,458	
	Mono-Color Waterline	SH	11	18	U1	28W x 28D x 29H	2.8	2,417	2,655	2,783	2,912	3,040	3,169	3,312	3,454	3,620	3,836	4,093	4,200	4,444	4,649
	Dual-Color Waterline	SH	11	18	U2	28W x 28D x 29H	2.5 above Waterline 0.8 below Waterline	2,417	2,696	2,846	3,004	3,152	3,305	3,469	3,638	3,836	4,089	4,392	4,518	4,806	5,047
	No Waterline Back & Seat	SH	11	18	U3	28W x 28D x 29H	1.1 Back 1.7 Seat	2,227	2,462	2,592	2,720	2,846	2,976	3,119	3,262	3,429	3,643	3,901	4,009	4,254	4,458
	Waterline Back & Seat	SH	11	18	U4	28W x 28D x 29H	1.1 Back 1.7 Seat/below Waterline	2,417	2,655	2,783	2,912	3,040	3,169	3,312	3,454	3,620	3,836	4,093	4,200	4,444	4,649
	Triple-Back & Seat & Waterline	SH	11	18	U8	28W x 28D x 29H	0.8 below Waterline 1.1 Back 1.4 Seat/above Waterline	2,417	2,696	2,846	3,004	3,152	3,305	3,469	3,638	3,836	4,089	4,392	4,518	4,806	5,047

### To Order Select Below

#### 1. Series/Type/Seat

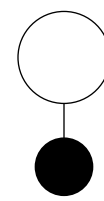

SH1118

**Share**  
Chair, Single-Seater,  
Task Height

#### 2. Leg

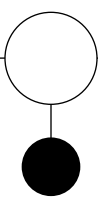

##### Leg

- L1 CORNER LEG, ADJ. PLASTIC GLIDES
- L2 ROUND LEG, ADJ. PLASTIC GLIDES
- L3 WOOD LEG

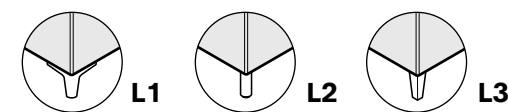

##### Mobility

The round leg glide has a larger diameter (1") than the corner leg for easier sliding on low pile carpet. Stylex is not responsible for damage to carpeting or floors.

#### 3. Leg Finish

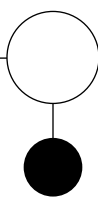

##### Standard Powder Coated Metal

- BL BLUE
- BM BLACK MATTE
- CP CHAMPAGNE
- DB DARK BRONZE
- DG DARK GRAY
- DP DUSTY PINK
- DS DARK SAGE
- LG LIGHT GRAY
- LL LILAC GRAY
- LP LIGHT PISTACHIO
- LR LIPSTICK RED
- MB MIDNIGHT BLUE

- MG MEADOW GREEN
- MK MILK
- MS METALLIC SILVER
- NK NICKEL
- OC OCHRE
- PY PALE YELLOW
- RO RED ORANGE
- RR RUSTY RED
- SB SOFT BLUE
- SD SAND
- TC TERRACOTTA
- TP TAUPE

#### 4. Options

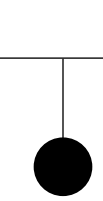

##### Polished Aluminum

- AL POLISHED ALUMINUM

##### Wood Finish +224

- 81 WHITE OAK
- 83 NATURAL MAPLE
- 85 WALNUT

##### Custom Color Match

- 09 CUSTOM COLOR

Per order per color - 20 chair minimum.  
Contact customer service for details.

#### 5. Upholstery Style

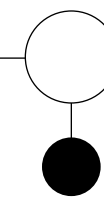

##### Ganging

- SG GANGING +53

Used to connect chairs to adjacent chairs or benches.

##### Power

- IN-SEAT POWER  
C1X PORT W/10' CORD +452

- IN-SEAT POWER  
C2X PORT W/20' CORD +485

See [page 7](#) for power port spec info.

##### Power Port Finish

Power ports can be finished in any standard powder coat available.

#### 6. Upholstery

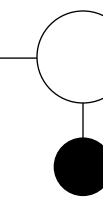

##### Upholstery Style

- U1 MONO-COLOR WATERLINE
- U2 DUAL-COLOR WATERLINE
- U3 SEAT & BACK, NO WATERLINE
- U4 SEAT & BACK, WITH WATERLINE
- U8 TRI-COLOR - SEAT, BACK & WATERLINE

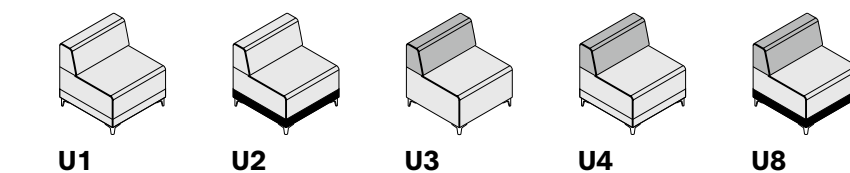

When pricing models with more than one fabric, the higher grade fabric will determine the overall grade of the specific product.

#### Upholstery

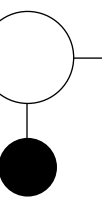

##### Upholstery

See [general information section](#) for details on textile program and COM/COL information.

Share will develop comfort wrinkles over time. The extent of these wrinkles is determined by the fabric specified.

# Share

CHAIR: SINGLE-SEATER, BANQUETTE HEIGHT

## Textile Upholstery Grades

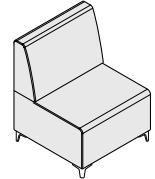
TITLE	SERIES	TYPE	SEAT	UPH	DIMENSIONS	YDG	COM	A	B	C	D	E	F	G	H	I	J	K	L	M	
 <b>Chair, Single-Seater, Banquette Height</b>	Standard Upholstery	SH	71	18	28W x 28D x 36H	3.1	2,525	2,788	2,931	3,069	3,212	3,356	3,512	3,671	3,853	4,096	4,380	4,487	4,760	4,957	
	Mono-Color Waterline	SH	71	18	U1	28W x 28D x 36H	3.1	2,715	2,978	3,122	3,261	3,404	3,546	3,703	3,860	4,046	4,286	4,572	4,671	4,941	5,144
	Dual-Color Waterline	SH	71	18	U2	28W x 28D x 36H	2.8 above Waterline 0.8 below Waterline	2,715	3,020	3,187	3,348	3,513	3,681	3,863	4,046	4,260	4,539	4,870	5,002	5,319	5,549
	No Waterline Back & Seat	SH	71	18	U3	28W x 28D x 36H	1.4 Back 1.7 Seat	2,525	2,788	2,931	3,069	3,212	3,356	3,512	3,671	3,853	4,096	4,380	4,487	4,760	4,957
	Waterline Back & Seat	SH	71	18	U4	28W x 28D x 36H	1.4 Back 1.8 Seat/below Waterline	2,715	2,978	3,122	3,261	3,404	3,546	3,703	3,860	4,046	4,286	4,572	4,671	4,941	5,144
	Triple-Back & Seat & Waterline	SH	71	18	U8	28W x 28D x 36H	0.8 below Waterline 1.4 Back 1.4 Seat/above Waterline	2,715	3,020	3,187	3,348	3,513	3,681	3,863	4,046	4,260	4,539	4,870	5,002	5,319	5,549

### To Order Select Below

#### 1. Series/Type/Seat

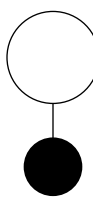

SH7118

**Share**  
Chair, Single-Seater,  
Banquette Height

#### 2. Leg

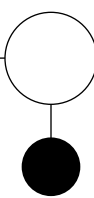

**Leg**

- L1 CORNER LEG, ADJ. PLASTIC GLIDES
- L2 ROUND LEG, ADJ. PLASTIC GLIDES
- L3 WOOD LEG

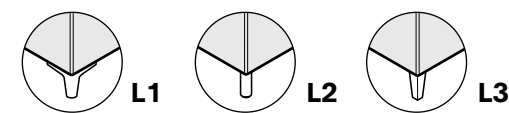

#### Mobility

The round leg glide has a larger diameter (1") than the corner leg for easier sliding on low pile carpet. Stylex is not responsible for damage to carpeting or floors.

#### 3. Leg Finish

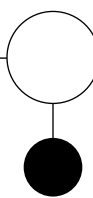

**Standard Powder Coated Metal**

- BL BLUE
- BM BLACK MATTE
- CP CHAMPAGNE
- DB DARK BRONZE
- DG DARK GRAY
- DP DUSTY PINK
- DS DARK SAGE
- LG LIGHT GRAY
- LL LILAC GRAY
- LP LIGHT PISTACHIO
- LR LIPSTICK RED
- MB MIDNIGHT BLUE

- MG MEADOW GREEN
- MK MILK
- MS METALLIC SILVER
- NK NICKEL
- OC OCHRE
- PY PALE YELLOW
- RO RED ORANGE
- RR RUSTY RED
- SB SOFT BLUE
- SD SAND
- TC TERRACOTTA
- TP TAUPE

#### 4. Options

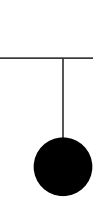

**Polished Aluminum**

- AL POLISHED ALUMINUM

**Wood Finish +224**

- 81 WHITE OAK
- 83 NATURAL MAPLE
- 85 WALNUT

**Custom Color Match**

- 09 CUSTOM COLOR

Per order per color - 20 chair minimum.  
Contact customer service for details.

#### 4. Options

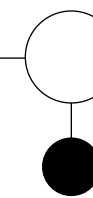

**Ganging**

- SG GANGING **+53**

Used to connect chairs to adjacent chairs or benches.

**Power**

- IN-SEAT POWER  
C1X PORT W/10' CORD **+452**
- IN-SEAT POWER  
C2X PORT W/20' CORD **+485**

See [page 7](#) for power port spec info.

#### Power Port Finish

Power ports can be finished in any standard powder coat available.

#### 5. Upholstery Style

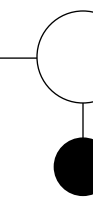

**Upholstery Style**

- U1 MONO-COLOR WATERLINE
- U2 DUAL-COLOR WATERLINE
- U3 SEAT & BACK, NO WATERLINE
- U4 SEAT & BACK, WITH WATERLINE
- U8 TRI-COLOR - SEAT, BACK & WATERLINE

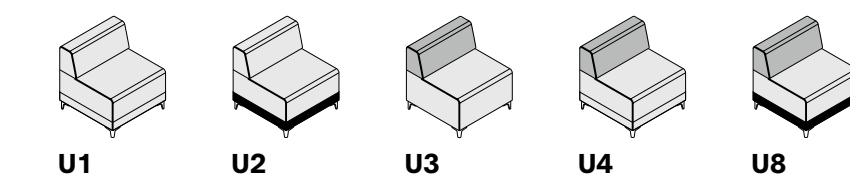

When pricing models with more than one fabric, the higher grade fabric will determine the overall grade of the specific product.

#### 6. Upholstery

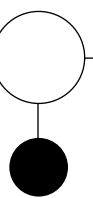

**Upholstery**

See [general information section](#) for details on textile program and COM/COL information.

Share will develop comfort wrinkles over time. The extent of these wrinkles is determined by the fabric specified.

# Share

CHAIR: TWO-SEATER, LOUNGE HEIGHT

## Textile Upholstery Grades

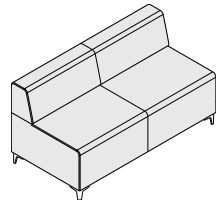
TITLE	SERIES	TYPE	SEAT	UPH	DIMENSIONS	YDG	COM	A	B	C	D	E	F	G	H	I	J	K	L	M	
 <b>Chair, Two-Seater, Lounge Height</b>	Standard Upholstery	SH	11	26	56W x 28D x 29H	5.6	3,684	4,156	4,412	4,671	4,929	5,188	5,471	5,758	6,089	6,518	7,036	7,249	7,739	8,147	
	Mono-Color Waterline	SH	11	26	U1	56W x 28D x 29H	5.7	3,951	4,434	4,697	4,957	5,220	5,482	5,770	6,062	6,400	6,840	7,362	7,580	8,078	8,494
	Dual-Color Waterline	SH	11	26	U2	56W x 28D x 29H	4.9 above Waterline 0.9 below Waterline	3,951	4,441	4,708	4,977	5,243	5,510	5,803	6,098	6,444	6,889	7,424	7,644	8,150	8,574
	No Waterline Back & Seat	SH	11	26	U3	56W x 28D x 29H	2.4 Back 3.2 Seat	3,684	4,156	4,412	4,671	4,929	5,188	5,471	5,758	6,089	6,518	7,036	7,249	7,739	8,147
	Waterline Back & Seat	SH	11	26	U4	56W x 28D x 29H	2.4 Back 3.2 Seat/below Waterline	3,951	4,434	4,697	4,957	5,220	5,482	5,770	6,062	6,400	6,840	7,362	7,516	8,006	8,415
	Triple-Back & Seat & Waterline	SH	11	26	U8	56W x 28D x 29H	0.9 below Waterline 2.4 Back 2.5 Seat/above Waterline	3,951	4,441	4,708	4,977	5,243	5,510	5,803	6,098	6,444	6,889	7,424	7,644	8,150	8,574

### To Order Select Below

#### 1. Series/Type/Seat

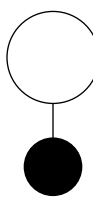

SH1126

**Share  
Chair, Two-Seater,  
Lounge Height**

#### 2. Leg

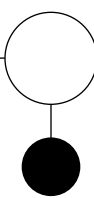

**Leg**

- L1 CORNER LEG, ADJ. PLASTIC GLIDES
- L2 ROUND LEG, ADJ. PLASTIC GLIDES
- L3 WOOD LEG

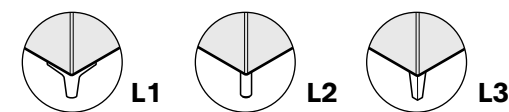

#### Mobility

The round leg glide has a larger diameter (1") than the corner leg for easier sliding on low pile carpet. Stylex is not responsible for damage to carpeting or floors.

#### 3. Leg Finish

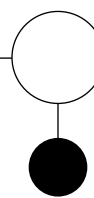

**Standard Powder Coated Metal**

- BL BLUE
- BM BLACK MATTE
- CP CHAMPAGNE
- DB DARK BRONZE
- DG DARK GRAY
- DP DUSTY PINK
- DS DARK SAGE
- LG LIGHT GRAY
- LL LILAC GRAY
- LP LIGHT PISTACHIO
- LR LIPSTICK RED
- MB MIDNIGHT BLUE

- MG MEADOW GREEN
- MK MILK
- MS METALLIC SILVER
- NK NICKEL
- OC OCHRE
- PY PALE YELLOW
- RO RED ORANGE
- RR RUSTY RED
- SB SOFT BLUE
- SD SAND
- TC TERRACOTTA
- TP TAUPE

**Polished Aluminum**

- AL POLISHED ALUMINUM

**Wood Finish +224**

- 81 WHITE OAK
- 83 NATURAL MAPLE
- 85 WALNUT

**Custom Color Match**

- 09 CUSTOM COLOR

Per order per color - 20 chair minimum.  
Contact customer service for details.

#### 4. Options

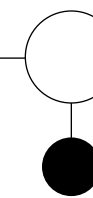

**Ganging**

- SG GANGING **+53**

Used to connect chairs to adjacent chairs or benches.

**Power**

- IN-SEAT POWER  
C1X PORT W/10' CORD **+452**
- IN-SEAT POWER  
C2X PORT W/20' CORD **+485**

See [page 7](#) for power port spec info.

#### Power Port Finish

Power ports can be finished in any standard powder coat available.

#### 5. Upholstery Style

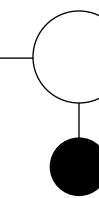

**Upholstery Style**

- U1 MONO-COLOR WATERLINE
- U2 DUAL-COLOR WATERLINE
- U3 SEAT & BACK, NO WATERLINE
- U4 SEAT & BACK, WITH WATERLINE
- U8 TRI-COLOR - SEAT, BACK & WATERLINE

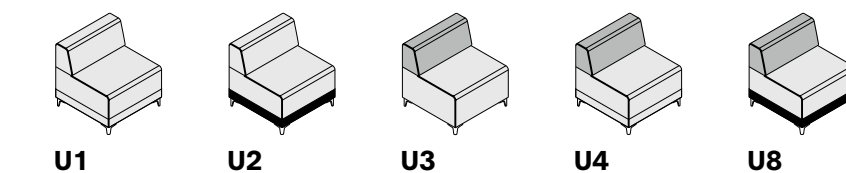

When pricing models with more than one fabric, the higher grade fabric will determine the overall grade of the specific product.

#### 6. Upholstery

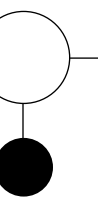

**Upholstery**

**See general information section for details on textile program and COM/COL information.**

Share will develop comfort wrinkles over time. The extent of these wrinkles is determined by the fabric specified.

# Share

CHAIR: TWO-SEATER, TASK HEIGHT

## Textile Upholstery Grades

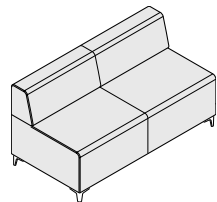
TITLE	SERIES	TYPE	SEAT	UPH	DIMENSIONS	YDG	COM	A	B	C	D	E	F	G	H	I	J	K	L	M
<b>Chair, Two-Seater, Task Height</b> 	Standard Upholstery	SH	11	28	56W x 28D x 29H	5.6	3,684	4,156	4,412	4,671	4,929	5,188	5,471	5,758	6,089	6,518	7,036	7,249	7,739	8,147
	Mono-Color Waterline	SH	11	28	56W x 28D x 29H	5.7	3,951	4,434	4,697	4,957	5,220	5,482	5,770	6,062	6,400	6,840	7,362	7,580	8,078	8,494
	Dual-Color Waterline	SH	11	28	56W x 28D x 29H	4.9 above Waterline 0.9 below Waterline	3,951	4,441	4,708	4,977	5,243	5,510	5,803	6,098	6,444	6,889	7,424	7,644	8,150	8,574
	No Waterline Back & Seat	SH	11	28	56W x 28D x 29H	2.2 Back 3.4 Seat	3,684	4,156	4,412	4,671	4,929	5,188	5,471	5,758	6,089	6,518	7,036	7,249	7,739	8,147
	Waterline Back & Seat	SH	11	28	56W x 28D x 29H	2.2 Back 3.4 Seat/below Waterline	3,951	4,434	4,697	4,957	5,220	5,482	5,770	6,062	6,400	6,840	7,362	7,516	8,006	8,415
	Triple-Back & Seat & Waterline	SH	11	28	56W x 28D x 29H	0.9 below Waterline 2.2 Back 2.7 Seat/above Waterline	3,951	4,441	4,708	4,977	5,243	5,510	5,803	6,098	6,444	6,889	7,424	7,644	8,150	8,574

### To Order Select Below

#### 1. Series/Type/Seat

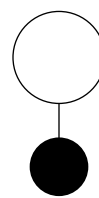

SH1128

**Share**  
Chair, Two-Seater,  
Task Height

#### 2. Leg

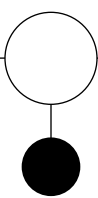

##### Leg

- L1 CORNER LEG, ADJ. PLASTIC GLIDES
- L2 ROUND LEG, ADJ. PLASTIC GLIDES
- L3 WOOD LEG

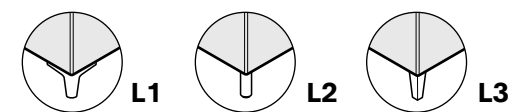

##### Mobility

The round leg glide has a larger diameter (1") than the corner leg for easier sliding on low pile carpet. Stylex is not responsible for damage to carpeting or floors.

#### 3. Leg Finish

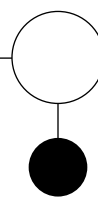

##### Standard Powder Coated Metal

- BL BLUE
- BM BLACK MATTE
- CP CHAMPAGNE
- DB DARK BRONZE
- DG DARK GRAY
- DP DUSTY PINK
- DS DARK SAGE
- LG LIGHT GRAY
- LL LILAC GRAY
- LP LIGHT PISTACHIO
- LR LIPSTICK RED
- MB MIDNIGHT BLUE

- MG MEADOW GREEN
- MK MILK
- MS METALLIC SILVER
- NK NICKEL
- OC OCHRE
- PY PALE YELLOW
- RO RED ORANGE
- RR RUSTY RED
- SB SOFT BLUE
- SD SAND
- TC TERRACOTTA
- TP TAUPE

#### 4. Options

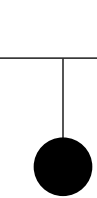

##### Polished Aluminum

- AL POLISHED ALUMINUM

##### Wood Finish +224

- 81 WHITE OAK
- 83 NATURAL MAPLE
- 85 WALNUT

##### Custom Color Match

- 09 CUSTOM COLOR

Per order per color - 20 chair minimum.  
Contact customer service for details.

#### 4. Options

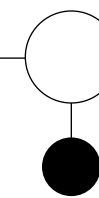

##### Ganging

- SG GANGING +53

Used to connect chairs to adjacent chairs or benches.

##### Power

- IN-SEAT POWER  
C1X PORT W/10' CORD +452
- IN-SEAT POWER  
C2X PORT W/20' CORD +485

See [page 7](#) for power port spec info.

##### Power Port Finish

Power ports can be finished in any standard powder coat available.

#### 5. Upholstery Style

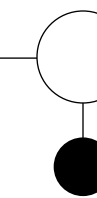

##### Upholstery Style

- U1 MONO-COLOR WATERLINE
- U2 DUAL-COLOR WATERLINE
- U3 SEAT & BACK, NO WATERLINE
- U4 SEAT & BACK, WITH WATERLINE
- U8 TRI-COLOR - SEAT, BACK & WATERLINE

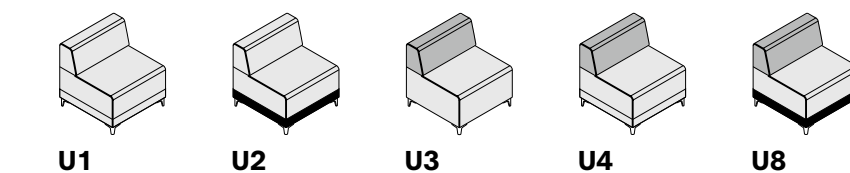

When pricing models with more than one fabric, the higher grade fabric will determine the overall grade of the specific product.

#### 6. Upholstery

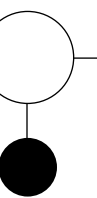

##### Upholstery

See [general information section](#) for details on textile program and COM/COL information.

Share will develop comfort wrinkles over time. The extent of these wrinkles is determined by the fabric specified.

# Share

CHAIR: TWO-SEATER, BANQUETTE HEIGHT

## Textile Upholstery Grades

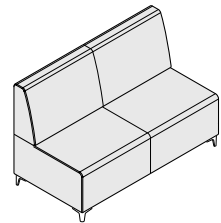
TITLE	SERIES	TYPE	SEAT	UPH	DIMENSIONS	YDG	COM	A	B	C	D	E	F	G	H	I	J	K	L	M
<b>Chair, Two-Seater, Banquette Height</b>  	Standard Upholstery	SH	71	28	56W x 28D x 36H	6.2	4,279	4,806	5,092	5,368	5,656	5,942	6,255	6,571	6,940	7,420	7,992	8,236	8,778	9,176
	Mono-Color Waterline	SH	71	28	56W x 28D x 36H	6.1	4,547	5,067	5,349	5,620	5,901	6,182	6,491	6,801	7,165	7,639	8,199	8,427	8,961	9,355
	Dual-Color Waterline	SH	71	28	56W x 28D x 36H	5.4 above Waterline 0.9 below Waterline	4,547	5,081	5,375	5,654	5,947	6,238	6,556	6,875	7,251	7,739	8,320	8,561	9,110	9,518
	No Waterline Back & Seat	SH	71	28	56W x 28D x 36H	2.7 Back 3.4 Seat	4,279	4,806	5,092	5,368	5,656	5,942	6,255	6,571	6,940	7,420	7,992	8,236	8,778	9,176
	Waterline Back & Seat	SH	71	28	56W x 28D x 36H	2.7 Back 3.5 Seat/below Waterline	4,547	5,067	5,349	5,620	5,901	6,182	6,491	6,801	7,165	7,639	8,199	8,427	8,961	9,355
	Triple-Back & Seat & Waterline	SH	71	28	56W x 28D x 36H	0.9 below Waterline 2.7 Back 2.7 Seat/above Waterline	4,547	5,081	5,375	5,654	5,947	6,238	6,556	6,875	7,251	7,739	8,320	8,561	9,110	9,518

### To Order Select Below

#### 1. Series/Type/Seat

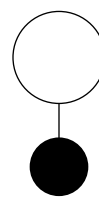

SH7128

**Share**  
Chair, Two-Seater,  
Banquette Height

#### 2. Leg

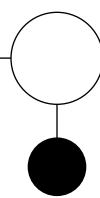

**Leg**

- L1 CORNER LEG, ADJ. PLASTIC GLIDES
- L2 ROUND LEG, ADJ. PLASTIC GLIDES
- L3 WOOD LEG

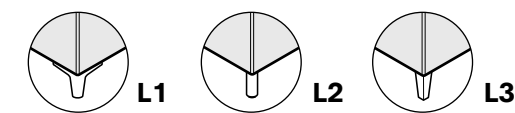

#### Mobility

The round leg glide has a larger diameter (1") than the corner leg for easier sliding on low pile carpet. Stylex is not responsible for damage to carpeting or floors.

#### 3. Leg Finish

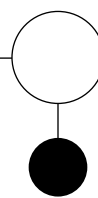

**Standard Powder Coated Metal**

- BL BLUE
- BM BLACK MATTE
- CP CHAMPAGNE
- DB DARK BRONZE
- DG DARK GRAY
- DP DUSTY PINK
- DS DARK SAGE
- LG LIGHT GRAY
- LL LILAC GRAY
- LP LIGHT PISTACHIO
- LR LIPSTICK RED
- MB MIDNIGHT BLUE

- MG MEADOW GREEN
- MK MILK
- MS METALLIC SILVER
- NK NICKEL
- OC OCHRE
- PY PALE YELLOW
- RO RED ORANGE
- RR RUSTY RED
- SB SOFT BLUE
- SD SAND
- TC TERRACOTTA
- TP TAUPE

#### 4. Options

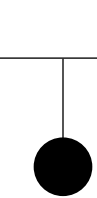

**Polished Aluminum**

- AL POLISHED ALUMINUM

**Wood Finish +224**

- 81 WHITE OAK
- 83 NATURAL MAPLE
- 85 WALNUT

**Custom Color Match**

- 09 CUSTOM COLOR

Per order per color - 20 chair minimum.  
Contact customer service for details.

#### 4. Options

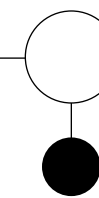

**Ganging**

- SG GANGING **+53**

Used to connect chairs to adjacent chairs or benches.

**Power**

- IN-SEAT POWER  
C1X PORT W/10' CORD **+452**
- IN-SEAT POWER  
C2X PORT W/20' CORD **+485**

See [page 7](#) for power port spec info.

#### Power Port Finish

Power ports can be finished in any standard powder coat available.

#### 5. Upholstery Style

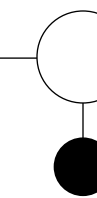

**Upholstery Style**

- U1 MONO-COLOR WATERLINE
- U2 DUAL-COLOR WATERLINE
- U3 SEAT & BACK, NO WATERLINE
- U4 SEAT & BACK, WITH WATERLINE
- U8 TRI-COLOR - SEAT, BACK & WATERLINE

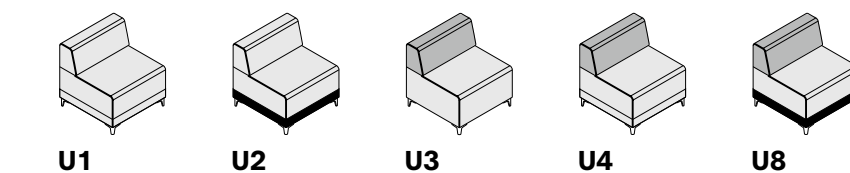

When pricing models with more than one fabric, the higher grade fabric will determine the overall grade of the specific product.

#### 6. Upholstery

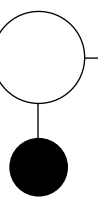

**Upholstery**

See [general information section](#) for details on textile program and COM/COL information.

Share will develop comfort wrinkles over time. The extent of these wrinkles is determined by the fabric specified.



# Share

CHAIR: THREE-SEATER, LOUNGE HEIGHT

## Textile Upholstery Grades

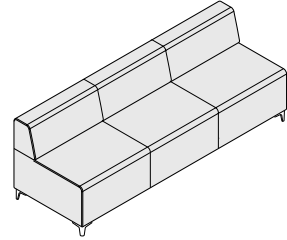
TITLE	SERIES	TYPE	SEAT	UPH	DIMENSIONS	YDG	COM	A	B	C	D	E	F	G	H	I	J	K	L	M	
<b>Chair, Three-Seater, Lounge Height</b> 	Standard Upholstery	SH	11	36	84W x 28D x 29H	8.5	5,065	5,782	6,176	6,563	6,958	7,346	7,777	8,209	8,715	9,369	10,152	10,476	11,220	11,839	
	Mono-Color Waterline	SH	11	36	U1	84W x 28D x 29H	8.5	5,450	6,166	6,557	6,951	7,339	7,733	8,163	8,595	9,101	9,754	10,536	10,861	11,604	12,224
	Dual-Color Waterline	SH	11	36	U2	84W x 28D x 29H	7.3 above Waterline 1.6 below Waterline	5,450	6,198	6,609	7,019	7,429	7,838	8,290	8,740	9,273	9,955	10,774	11,116	11,893	12,543
	No Waterline Back & Seat	SH	11	36	U3	84W x 28D x 29H	3.6 Back 4.9 Seat	5,065	5,782	6,176	6,563	6,958	7,346	7,777	8,209	8,715	9,369	10,152	10,476	11,220	11,839
	Waterline Back & Seat	SH	11	36	U4	84W x 28D x 29H	3.6 Back 4.9 Seat/below Waterline	5,450	6,166	6,557	6,951	7,339	7,733	8,163	8,595	9,101	9,754	10,536	10,861	11,604	12,224
	Triple-Back & Seat & Waterline	SH	11	36	U8	84W x 28D x 29H	1.6 below Waterline 3.6 Back 3.7 Seat/above Waterline	5,450	6,198	6,609	7,019	7,429	7,838	8,290	8,740	9,273	9,955	10,774	11,116	11,893	12,543

### To Order Select Below

#### 1. Series/Type/Seat

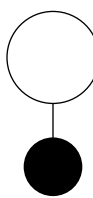

SH1136

**Share**  
Chair, Three-Seater,  
Lounge Height

#### 2. Leg

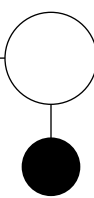

##### Leg

- L1 CORNER LEG, ADJ. PLASTIC GLIDES
- L2 ROUND LEG, ADJ. PLASTIC GLIDES
- L3 WOOD LEG

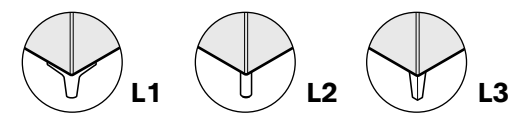

##### Mobility

The round leg glide has a larger diameter (1") than the corner leg for easier sliding on low pile carpet. Stylex is not responsible for damage to carpeting or floors.

#### 3. Leg Finish

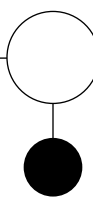

##### Standard Powder Coated Metal

- BL BLUE
- BM BLACK MATTE
- CP CHAMPAGNE
- DB DARK BRONZE
- DG DARK GRAY
- DP DUSTY PINK
- DS DARK SAGE
- LG LIGHT GRAY
- LL LILAC GRAY
- LP LIGHT PISTACHIO
- LR LIPSTICK RED
- MB MIDNIGHT BLUE

- MG MEADOW GREEN
- MK MILK
- MS METALLIC SILVER
- NK NICKEL
- OC OCHRE
- PY PALE YELLOW
- RO RED ORANGE
- RR RUSTY RED
- SB SOFT BLUE
- SD SAND
- TC TERRACOTTA
- TP TAUPE

#### 4. Options

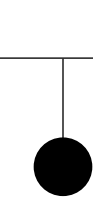

##### Polished Aluminum

- AL POLISHED ALUMINUM

##### Wood Finish +224

- 81 WHITE OAK
- 83 NATURAL MAPLE
- 85 WALNUT

##### Custom Color Match

- 09 CUSTOM COLOR

Per order per color - 20 chair minimum.  
Contact customer service for details.

#### 5. Upholstery Style

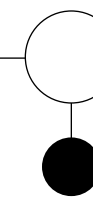

##### Ganging

- SG GANGING +53

Used to connect chairs to adjacent chairs or benches.

##### Power

- C1X IN-SEAT POWER PORT W/10' CORD +452

- C2X IN-SEAT POWER PORT W/20' CORD +485

See [page 7](#) for power port spec info.

##### Power Port Finish

Power ports can be finished in any standard powder coat available.

#### 6. Upholstery

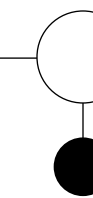

##### Upholstery Style

- U1 MONO-COLOR WATERLINE
- U2 DUAL-COLOR WATERLINE
- U3 SEAT & BACK, NO WATERLINE
- U4 SEAT & BACK, WITH WATERLINE
- U8 TRI-COLOR - SEAT, BACK & WATERLINE

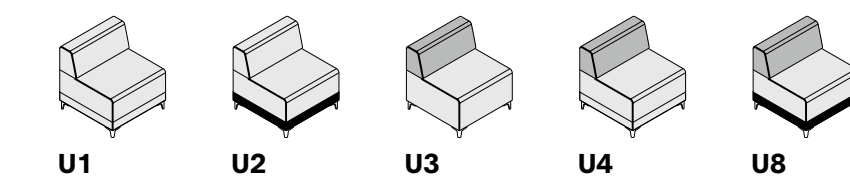

When pricing models with more than one fabric, the higher grade fabric will determine the overall grade of the specific product.

##### Upholstery

See [general information section](#) for details on textile program and COM/COL information.

Share will develop comfort wrinkles over time. The extent of these wrinkles is determined by the fabric specified.

# Share

CHAIR: THREE-SEATER, TASK HEIGHT

## Textile Upholstery Grades

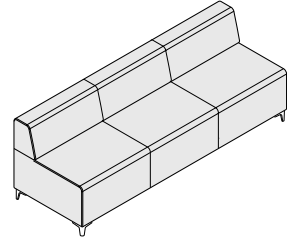
TITLE	SERIES	TYPE	SEAT	UPH	DIMENSIONS	YDG	COM	A	B	C	D	E	F	G	H	I	J	K	L	M	
<b>Chair, Three-Seater, Task Height</b> 	Standard Upholstery	SH	11	38	84W x 28D x 29H	8.5	5,065	5,782	6,176	6,563	6,958	7,346	7,777	8,209	8,715	9,369	10,152	10,476	11,220	11,839	
	Mono-Color Waterline	SH	11	38	U1	84W x 28D x 29H	8.5	5,450	6,166	6,557	6,951	7,339	7,733	8,163	8,595	9,101	9,754	10,536	10,861	11,604	12,224
	Dual-Color Waterline	SH	11	38	U2	84W x 28D x 29H	7.3 above Waterline 1.6 below Waterline	5,450	6,198	6,609	7,019	7,429	7,838	8,290	8,740	9,273	9,955	10,774	11,116	11,893	12,543
	No Waterline Back & Seat	SH	11	38	U3	84W x 28D x 29H	3.3 Back 5.2 Seat	5,065	5,782	6,176	6,563	6,958	7,346	7,777	8,209	8,715	9,369	10,152	10,476	11,220	11,839
	Waterline Back & Seat	SH	11	38	U4	84W x 28D x 29H	3.3 Back 5.2 Seat/below Waterline	5,450	6,166	6,557	6,951	7,339	7,733	8,163	8,595	9,101	9,754	10,536	10,861	11,604	12,224
	Triple-Back & Seat & Waterline	SH	11	38	U8	84W x 28D x 29H	1.6 below Waterline 3.3 Back 4 Seat/above Waterline	5,450	6,198	6,609	7,019	7,429	7,838	8,290	8,740	9,273	9,955	10,774	11,116	11,893	12,543

### To Order Select Below

#### 1. Series/Type/Seat

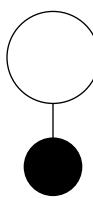

SH1138

**Share**  
Chair, Three-Seater,  
Task Height

#### 2. Leg

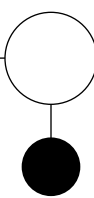

##### Leg

- L1 CORNER LEG, ADJ. PLASTIC GLIDES
- L2 ROUND LEG, ADJ. PLASTIC GLIDES
- L3 WOOD LEG

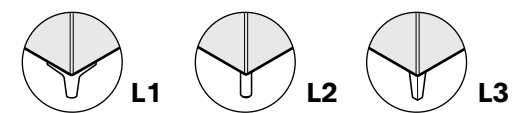

##### Mobility

The round leg glide has a larger diameter (1") than the corner leg for easier sliding on low pile carpet. Stylex is not responsible for damage to carpeting or floors.

#### 3. Leg Finish

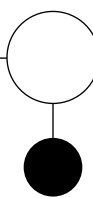

##### Standard Powder Coated Metal

- BL BLUE
- BM BLACK MATTE
- CP CHAMPAGNE
- DB DARK BRONZE
- DG DARK GRAY
- DP DUSTY PINK
- DS DARK SAGE
- LG LIGHT GRAY
- LL LILAC GRAY
- LP LIGHT PISTACHIO
- LR LIPSTICK RED
- MB MIDNIGHT BLUE

- MG MEADOW GREEN
- MK MILK
- MS METALLIC SILVER
- NK NICKEL
- OC OCHRE
- PY PALE YELLOW
- RO RED ORANGE
- RR RUSTY RED
- SB SOFT BLUE
- SD SAND
- TC TERRACOTTA
- TP TAUPE

#### 4. Options

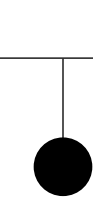

##### Polished Aluminum

- AL POLISHED ALUMINUM

##### Wood Finish +224

- 81 WHITE OAK
- 83 NATURAL MAPLE
- 85 WALNUT

##### Custom Color Match

- 09 CUSTOM COLOR

Per order per color - 20 chair minimum.  
Contact customer service for details.

#### 5. Upholstery Style

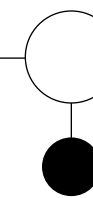

##### Ganging

- SG GANGING +53

Used to connect chairs to adjacent chairs or benches.

##### Power

- IN-SEAT POWER  
C1X PORT W/10' CORD +452
- IN-SEAT POWER  
C2X PORT W/20' CORD +485

See [page 7](#) for power port spec info.

##### Power Port Finish

Power ports can be finished in any standard powder coat available.

#### 6. Upholstery

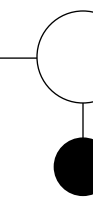

##### Upholstery Style

- U1 MONO-COLOR WATERLINE
- U2 DUAL-COLOR WATERLINE
- U3 SEAT & BACK, NO WATERLINE
- U4 SEAT & BACK, WITH WATERLINE
- U8 TRI-COLOR - SEAT, BACK & WATERLINE

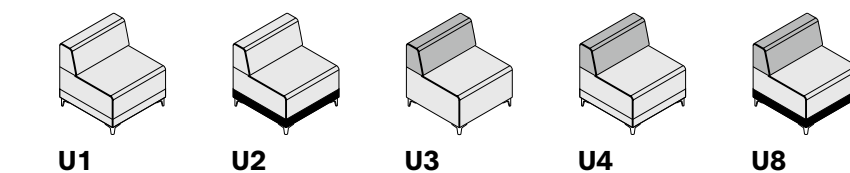

When pricing models with more than one fabric, the higher grade fabric will determine the overall grade of the specific product.

##### Upholstery

See [general information section](#) for details on textile program and COM/COL information.

Share will develop comfort wrinkles over time. The extent of these wrinkles is determined by the fabric specified.

# Share

CHAIR: THREE-SEATER, BANQUETTE HEIGHT

## Textile Upholstery Grades

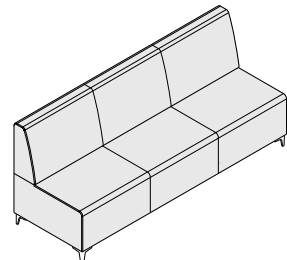
TITLE	SERIES	TYPE	SEAT	UPH	DIMENSIONS	YDG	COM	A	B	C	D	E	F	G	H	I	J	K	L	M
 <b>Chair, Three-Seater, Banquette Height</b>	Standard Upholstery	SH	71	38	84W x 28D x 36H	9.2	5,958	6,739	7,165	7,575	8,002	8,426	8,891	9,359	9,907	10,618	11,467	11,846	12,647	13,242
	Mono-Color Waterline	SH	71	38	84W x 28D x 36H	9.1	6,225	7,000	7,420	7,826	8,247	8,667	9,128	9,588	10,132	10,837	11,676	12,035	12,832	13,418
	Dual-Color Waterline	SH	71	38	84W x 28D x 36H	8 above Waterline 1.6 below Waterline	6,225	7,041	7,485	7,913	8,357	8,800	9,285	9,775	10,347	11,091	11,976	12,368	13,208	13,826
	No Waterline Back & Seat	SH	71	38	84W x 28D x 36H	4 Back 5.1 Seat	5,958	6,739	7,165	7,575	8,002	8,426	8,891	9,359	9,907	10,618	11,467	11,846	12,647	13,242
	Waterline Back & Seat	SH	71	38	84W x 28D x 36H	4 Back 5.2 Seat/below Waterline	6,225	7,000	7,420	7,826	8,247	8,667	9,128	9,588	10,132	10,837	11,676	12,035	12,832	13,418
	Triple-Back & Seat & Waterline	SH	71	38	84W x 28D x 36H	1.6 below Waterline 4 Back 4 Seat/above Waterline	6,225	7,041	7,485	7,913	8,357	8,800	9,285	9,775	10,347	11,091	11,976	12,368	13,208	13,826

### To Order Select Below

#### 1. Series/Type/Seat

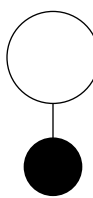

SH7138

**Share**  
**Chair, Three-Seater,**  
**Banquette Height**

#### 2. Leg

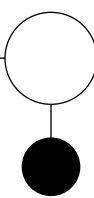

##### Leg

- L1 CORNER LEG, ADJ. PLASTIC GLIDES
- L2 ROUND LEG, ADJ. PLASTIC GLIDES
- L3 WOOD LEG

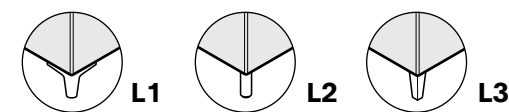

##### Mobility

The round leg glide has a larger diameter (1") than the corner leg for easier sliding on low pile carpet. Stylex is not responsible for damage to carpeting or floors.

#### 3. Leg Finish

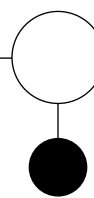

##### Standard Powder Coated Metal

- BL BLUE
- BM BLACK MATTE
- CP CHAMPAGNE
- DB DARK BRONZE
- DG DARK GRAY
- DP DUSTY PINK
- DS DARK SAGE
- LG LIGHT GRAY
- LL LILAC GRAY
- LP LIGHT PISTACHIO
- LR LIPSTICK RED
- MB MIDNIGHT BLUE

- MG MEADOW GREEN
- MK MILK
- MS METALLIC SILVER
- NK NICKEL
- OC OCHRE
- PY PALE YELLOW
- RO RED ORANGE
- RR RUSTY RED
- SB SOFT BLUE
- SD SAND
- TC TERRACOTTA
- TP TAUPE

#### 4. Options

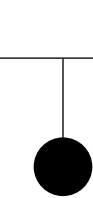

##### Polished Aluminum

- AL POLISHED ALUMINUM

##### Wood Finish +224

- 81 WHITE OAK
- 83 NATURAL MAPLE
- 85 WALNUT

##### Custom Color Match

- 09 CUSTOM COLOR

Per order per color - 20 chair minimum.  
Contact customer service for details.

#### 4. Options

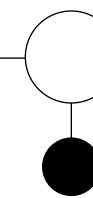

##### Ganging

- SG GANGING +53

Used to connect chairs to adjacent chairs or benches.

##### Power

- IN-SEAT POWER  
C1X PORT W/10' CORD +452
- IN-SEAT POWER  
C2X PORT W/20' CORD +485

See [page 7](#) for power port spec info.

##### Power Port Finish

Power ports can be finished in any standard powder coat available.

#### 5. Upholstery Style

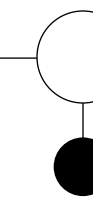

##### Upholstery Style

- U1 MONO-COLOR WATERLINE
- U2 DUAL-COLOR WATERLINE
- U3 SEAT & BACK, NO WATERLINE
- U4 SEAT & BACK, WITH WATERLINE
- U8 TRI-COLOR - SEAT, BACK & WATERLINE

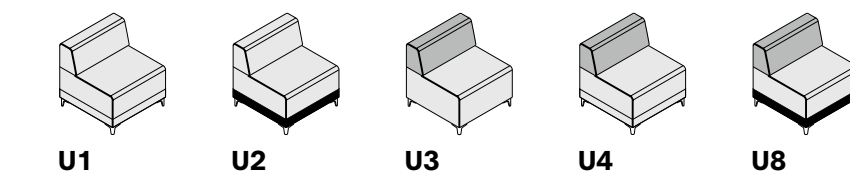

When pricing models with more than one fabric, the higher grade fabric will determine the overall grade of the specific product.

#### 6. Upholstery

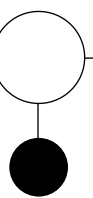

##### Upholstery

See [general information section](#) for details on textile program and COM/COL information.

Share will develop comfort wrinkles over time. The extent of these wrinkles is determined by the fabric specified.

# Share

CHAIR: 90° CORNER, LOUNGE HEIGHT

## Textile Upholstery Grades

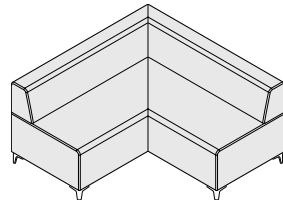
TITLE	SERIES	TYPE	SEAT	UPH	DIMENSIONS	YDG	COM	A	B	C	D	E	F	G	H	I	J	K	L	M
<b>Chair, 90° Corner, Lounge Height</b> 	Standard Upholstery	SH	12	26	56W x 28D x 29H	8	5,524	6,198	6,567	6,938	7,306	7,672	8,079	8,485	8,963	9,575	10,314	10,617	11,316	11,901
	Mono-Color Waterline	SH	12	26	56W x 28D x 29H	8.1	5,909	6,593	6,964	7,338	7,711	8,084	8,493	8,904	9,390	10,010	10,757	11,067	11,774	12,365
	Dual-Color Waterline	SH	12	26	56W x 28D x 29H	6.9 above Waterline 1.6 below Waterline	5,909	6,627	7,017	7,409	7,799	8,191	8,623	9,053	9,563	10,213	10,995	11,320	12,064	12,684
	No Waterline Back & Seat	SH	12	26	56W x 28D x 29H	3.6 Back 4.4 Seat	5,524	6,198	6,567	6,938	7,306	7,672	8,079	8,485	8,963	9,575	10,314	10,617	11,316	11,901
	Waterline Back & Seat	SH	12	26	56W x 28D x 29H	3.6 Back 4.4 Seat/below Waterline	5,909	6,593	6,964	7,338	7,711	8,084	8,493	8,904	9,390	10,010	10,757	11,002	11,701	12,286
	Triple-Back & Seat & Waterline	SH	12	26	56W x 28D x 29H	1.6 below Waterline 3.6 Back 3.3 Seat/above Waterline	5,909	6,627	7,017	7,409	7,799	8,191	8,623	9,053	9,563	10,213	10,995	11,320	12,064	12,684

### To Order Select Below

#### 1. Series/Type/Seat

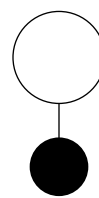

SH1226

**Share**  
Chair, 90° Corner  
Lounge Height

#### 2. Leg

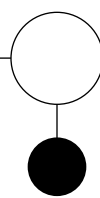

##### Leg

- L1 CORNER LEG, ADJ. PLASTIC GLIDES
- L2 ROUND LEG, ADJ. PLASTIC GLIDES
- L3 WOOD LEG

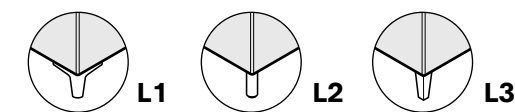

##### Mobility

The round leg glide has a larger diameter (1") than the corner leg for easier sliding on low pile carpet. Stylex is not responsible for damage to carpeting or floors.

#### 3. Leg Finish

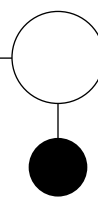

##### Standard Powder Coated Metal

- BL BLUE
- BM BLACK MATTE
- CP CHAMPAGNE
- DB DARK BRONZE
- DG DARK GRAY
- DP DUSTY PINK
- DS DARK SAGE
- LG LIGHT GRAY
- LL LILAC GRAY
- LP LIGHT PISTACHIO
- LR LIPSTICK RED
- MB MIDNIGHT BLUE

- MG MEADOW GREEN
- MK MILK
- MS METALLIC SILVER
- NK NICKEL
- OC OCHRE
- PY PALE YELLOW
- RO RED ORANGE
- RR RUSTY RED
- SB SOFT BLUE
- SD SAND
- TC TERRACOTTA
- TP TAUPE

#### 4. Options

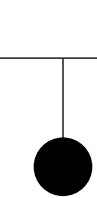

##### Polished Aluminum

- AL POLISHED ALUMINUM

##### Wood Finish +224

- 81 WHITE OAK
- 83 NATURAL MAPLE
- 85 WALNUT

##### Custom Color Match

- 09 CUSTOM COLOR

Per order per color - 20 chair minimum.  
Contact customer service for details.

#### 4. Options

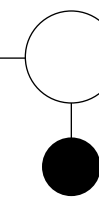

##### Ganging

- SG GANGING +53

Used to connect chairs to adjacent chairs or benches.

##### Power

- IN-SEAT POWER  
C1X PORT W/10' CORD +452
- IN-SEAT POWER  
C2X PORT W/20' CORD +485

See [page 7](#) for power port spec info.

##### Power Port Finish

Power ports can be finished in any standard powder coat available.

#### 5. Upholstery Style

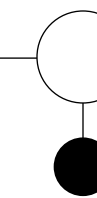

##### Upholstery Style

- U1 MONO-COLOR WATERLINE
- U2 DUAL-COLOR WATERLINE
- U3 SEAT & BACK, NO WATERLINE
- U4 SEAT & BACK, WITH WATERLINE
- U8 TRI-COLOR - SEAT, BACK & WATERLINE

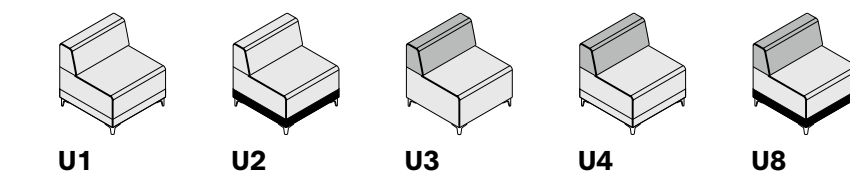

When pricing models with more than one fabric, the higher grade fabric will determine the overall grade of the specific product.

#### 6. Upholstery

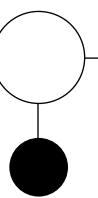

##### Upholstery

See [general information section](#) for details on textile program and COM/COL information.

Share will develop comfort wrinkles over time. The extent of these wrinkles is determined by the fabric specified.

# Share

CHAIR: 90° CORNER, TASK HEIGHT

## Textile Upholstery Grades

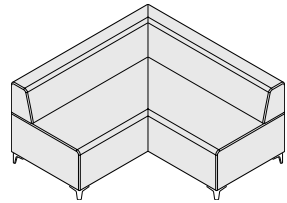
TITLE	SERIES	TYPE	SEAT	UPH	DIMENSIONS	YDG	COM	A	B	C	D	E	F	G	H	I	J	K	L	M	
<b>Chair, 90° Corner, Task Height</b> 	Standard Upholstery	SH	12	28	56W x 28D x 29H	8.5	5,524	6,244	6,636	7,026	7,417	7,811	8,238	8,668	9,175	9,829	10,611	10,936	11,679	12,299	
	Mono-Color Waterline	SH	12	28	U1	56W x 28D x 29H	8.5	5,909	6,627	7,017	7,409	7,799	8,191	8,623	9,053	9,563	10,213	10,995	11,320	12,064	12,684
	Dual-Color Waterline	SH	12	28	U2	56W x 28D x 29H	7.4 above Waterline 1.6 below Waterline	5,909	6,666	7,081	7,497	7,911	8,326	8,783	9,237	9,776	10,466	11,293	11,640	12,426	13,082
	No Waterline Back & Seat	SH	12	28	U3	56W x 28D x 29H	3.7 Back 4.8 Seat	5,524	6,244	6,636	7,026	7,417	7,811	8,238	8,668	9,175	9,829	10,611	10,936	11,679	12,299
	Waterline Back & Seat	SH	12	28	U4	56W x 28D x 29H	3.7 Back 4.8 Seat/below Waterline	5,909	6,627	7,017	7,409	7,799	8,191	8,623	9,053	9,563	10,213	10,995	11,320	12,064	12,684
	Triple-Back & Seat & Waterline	SH	12	28	U8	56W x 28D x 29H	1.6 below Waterline 3.7 Back 3.7 Seat/above Waterline	5,909	6,666	7,081	7,497	7,911	8,326	8,783	9,237	9,776	10,466	11,293	11,640	12,426	13,082

### To Order Select Below

#### 1. Series/Type/Seat

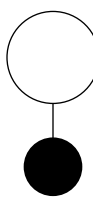

SH1228

**Share**  
Chair, 90° Corner  
Task Height

#### 2. Leg

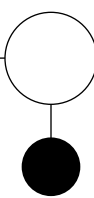

##### Leg

- L1 CORNER LEG, ADJ. PLASTIC GLIDES
- L2 ROUND LEG, ADJ. PLASTIC GLIDES
- L3 WOOD LEG

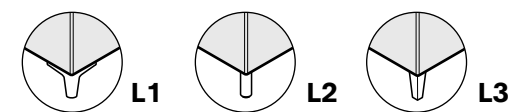

##### Mobility

The round leg glide has a larger diameter (1") than the corner leg for easier sliding on low pile carpet. Stylex is not responsible for damage to carpeting or floors.

#### 3. Leg Finish

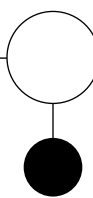

##### Standard Powder Coated Metal

- BL BLUE
- BM BLACK MATTE
- CP CHAMPAGNE
- DB DARK BRONZE
- DG DARK GRAY
- DP DUSTY PINK
- DS DARK SAGE
- LG LIGHT GRAY
- LL LILAC GRAY
- LP LIGHT PISTACHIO
- LR LIPSTICK RED
- MB MIDNIGHT BLUE

- MG MEADOW GREEN
- MK MILK
- MS METALLIC SILVER
- NK NICKEL
- OC OCHRE
- PY PALE YELLOW
- RO RED ORANGE
- RR RUSTY RED
- SB SOFT BLUE
- SD SAND
- TC TERRACOTTA
- TP TAUPE

#### 4. Options

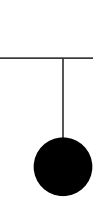

##### Polished Aluminum

- AL POLISHED ALUMINUM

##### Wood Finish +224

- 81 WHITE OAK
- 83 NATURAL MAPLE
- 85 WALNUT

##### Custom Color Match

- 09 CUSTOM COLOR

Per order per color - 20 chair minimum.  
Contact customer service for details.

#### 4. Options

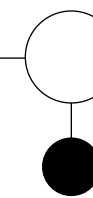

##### Ganging

- SG GANGING +53

Used to connect chairs to adjacent chairs or benches.

##### Power

- IN-SEAT POWER  
C1X PORT W/10' CORD +452
- IN-SEAT POWER  
C2X PORT W/20' CORD +485

See [page 7](#) for power port spec info.

##### Power Port Finish

Power ports can be finished in any standard powder coat available.

#### 5. Upholstery Style



##### Upholstery Style

- U1 MONO-COLOR WATERLINE
- U2 DUAL-COLOR WATERLINE
- U3 SEAT & BACK, NO WATERLINE
- U4 SEAT & BACK, WITH WATERLINE
- U8 TRI-COLOR - SEAT, BACK & WATERLINE

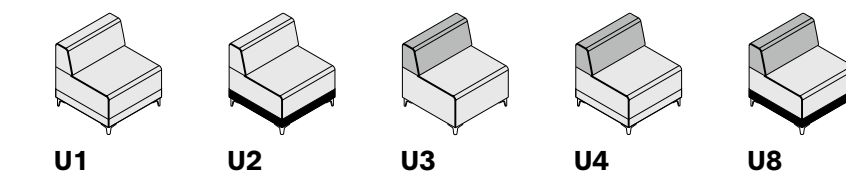

When pricing models with more than one fabric, the higher grade fabric will determine the overall grade of the specific product.

#### 6. Upholstery

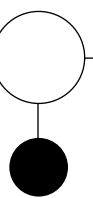

##### Upholstery

See [general information section](#) for details on textile program and COM/COL information.

Share will develop comfort wrinkles over time. The extent of these wrinkles is determined by the fabric specified.

# Share

CHAIR: 90° CORNER, BANQUETTE HEIGHT

## Textile Upholstery Grades

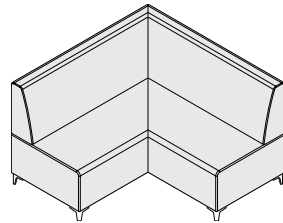
TITLE	SERIES	TYPE	SEAT	UPH	DIMENSIONS	YDG	COM	A	B	C	D	E	F	G	H	I	J	K	L	M	
<b>Chair, 90° Corner, Banquette Height</b> 	Standard Upholstery	SH	72	28	56W x 28D x 36H	9.2	6,717	7,497	7,925	8,336	8,759	9,185	9,651	10,116	10,664	11,378	12,226	12,575	13,380	13,970	
	Mono-Color Waterline	SH	72	28	U1	56W x 28D x 36H	9.1	7,101	7,875	8,296	8,702	9,122	9,541	10,002	10,463	11,006	11,710	12,551	12,876	13,674	14,259
	Dual-Color Waterline	SH	72	28	U2	56W x 28D x 36H	8.1 above Waterline 1.6 below Waterline	7,101	7,926	8,372	8,805	9,254	9,701	10,195	10,685	11,263	12,015	12,912	13,278	14,124	14,747
	No Waterline Back & Seat	SH	72	28	U3	56W x 28D x 36H	4.4 Back 4.8 Seat	6,717	7,497	7,925	8,336	8,759	9,185	9,651	10,116	10,664	11,378	12,226	12,575	13,380	13,970
	Waterline Back & Seat	SH	72	28	U4	56W x 28D x 36H	4.4 Back 4.9 Seat/below Waterline	7,101	7,875	8,296	8,702	9,122	9,541	10,002	10,463	11,006	11,710	12,551	12,876	13,674	14,259
	Triple-Back & Seat & Waterline	SH	72	28	U8	56W x 28D x 36H	1.6 below Waterline 4.4 Back 3.7 Seat/above Waterline	7,101	7,926	8,372	8,805	9,254	9,701	10,195	10,685	11,263	12,015	12,912	13,278	14,124	14,747

### To Order Select Below

#### 1. Series/Type/Seat



SH7228

**Share**  
Chair, 90° Corner  
Banquette Height

#### 2. Leg

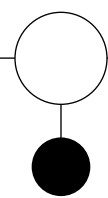

**Leg**

- L1 CORNER LEG, ADJ. PLASTIC GLIDES
- L2 ROUND LEG, ADJ. PLASTIC GLIDES
- L3 WOOD LEG

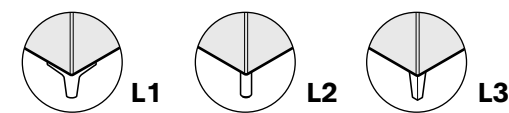

#### Mobility

The round leg glide has a larger diameter (1") than the corner leg for easier sliding on low pile carpet. Stylex is not responsible for damage to carpeting or floors.

#### 3. Leg Finish

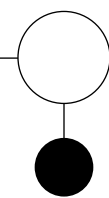

**Standard Powder Coated Metal**

- BL BLUE
- BM BLACK MATTE
- CP CHAMPAGNE
- DB DARK BRONZE
- DG DARK GRAY
- DP DUSTY PINK
- DS DARK SAGE
- LG LIGHT GRAY
- LL LILAC GRAY
- LP LIGHT PISTACHIO
- LR LIPSTICK RED
- MB MIDNIGHT BLUE

- MG MEADOW GREEN
- MK MILK
- MS METALLIC SILVER
- NK NICKEL
- OC OCHRE
- PY PALE YELLOW
- RO RED ORANGE
- RR RUSTY RED
- SB SOFT BLUE
- SD SAND
- TC TERRACOTTA
- TP TAUPE

#### 4. Options



**Polished Aluminum**

- AL POLISHED ALUMINUM

**Wood Finish +224**

- 81 WHITE OAK
- 83 NATURAL MAPLE
- 85 WALNUT

**Custom Color Match**

- 09 CUSTOM COLOR

Per order per color - 20 chair minimum.  
Contact customer service for details.

#### 4. Options

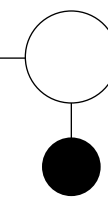

**Ganging**

- SG GANGING **+53**

Used to connect chairs to adjacent chairs or benches.

**Power**

- IN-SEAT POWER  
C1X PORT W/10' CORD **+452**

- IN-SEAT POWER  
C2X PORT W/20' CORD **+485**

See [page 7](#) for power port spec info.

#### Power Port Finish

Power ports can be finished in any standard powder coat available.

#### 5. Upholstery Style

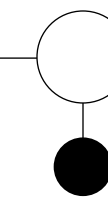

**Upholstery Style**

- U1 MONO-COLOR WATERLINE
- U2 DUAL-COLOR WATERLINE
- U3 SEAT & BACK, NO WATERLINE
- U4 SEAT & BACK, WITH WATERLINE
- U8 TRI-COLOR - SEAT, BACK & WATERLINE

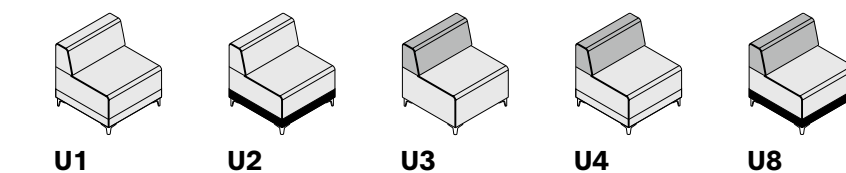

When pricing models with more than one fabric, the higher grade fabric will determine the overall grade of the specific product.

#### 6. Upholstery

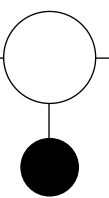

**Upholstery**

See [general information section](#) for details on textile program and COM/COL information.

Share will develop comfort wrinkles over time. The extent of these wrinkles is determined by the fabric specified.

# Share

CHAIR: 120° CORNER, LOUNGE HEIGHT

## Textile Upholstery Grades

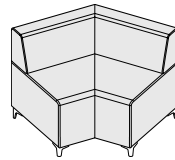
TITLE	SERIES	TYPE	SEAT	UPH	DIMENSIONS	YDG	COM	A	B	C	D	E	F	G	H	I	J	K	L	M
	Standard Upholstery	SH	12	46	42.5W x 28D x 29H	4.1	3,716	4,064	4,253	4,437	4,627	4,814	5,022	5,232	5,476	5,793	6,172	6,326	6,684	6,984
	Mono-Color Waterline	SH	12	46	42.5W x 28D x 29H	3.8	3,983	4,305	4,480	4,650	4,829	5,002	5,195	5,387	5,615	5,909	6,262	6,402	6,735	7,012
	Dual-Color Waterline	SH	12	46	42.5W x 28D x 29H	3.4 above Waterline 0.8 below Waterline	3,983	4,341	4,535	4,722	4,917	5,111	5,324	5,537	5,786	6,112	6,501	6,657	7,024	7,331
	No Waterline Back & Seat	SH	12	46	42.5W x 28D x 29H	1.7 Back 2.4 Seat	3,716	4,064	4,253	4,437	4,627	4,814	5,022	5,232	5,476	5,793	6,172	6,326	6,684	6,984
	Waterline Back & Seat	SH	12	46	42.5W x 28D x 29H	1.7 Back 2.4 Seat/below Waterline	3,983	4,305	4,480	4,650	4,829	5,002	5,195	5,387	5,615	5,909	6,262	6,594	6,951	7,251
	Triple-Back & Seat & Waterline	SH	12	46	42.5W x 28D x 29H	0.8 below Waterline 1.7 Back 1.7 Seat/above Waterline	3,983	4,341	4,535	4,722	4,917	5,111	5,324	5,537	5,786	6,112	6,501	6,657	7,024	7,331

### To Order Select Below

#### 1. Series/Type/Seat

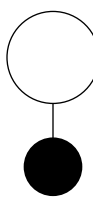

SH1246

**Share**  
Chair, 120° Corner  
Lounge Height

#### 2. Leg

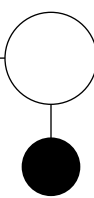

**Leg**

- L1 CORNER LEG, ADJ. PLASTIC GLIDES
- L2 ROUND LEG, ADJ. PLASTIC GLIDES
- L3 WOOD LEG

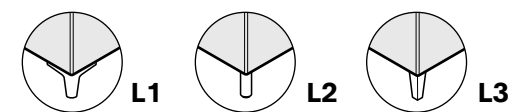

#### Mobility

The round leg glide has a larger diameter (1") than the corner leg for easier sliding on low pile carpet. Stylex is not responsible for damage to carpeting or floors.

#### 3. Leg Finish

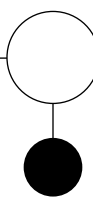

**Standard Powder Coated Metal**

- BL BLUE
- BM BLACK MATTE
- CP CHAMPAGNE
- DB DARK BRONZE
- DG DARK GRAY
- DP DUSTY PINK
- DS DARK SAGE
- LG LIGHT GRAY
- LL LILAC GRAY
- LP LIGHT PISTACHIO
- LR LIPSTICK RED
- MB MIDNIGHT BLUE

- MG MEADOW GREEN
- MK MILK
- MS METALLIC SILVER
- NK NICKEL
- OC OCHRE
- PY PALE YELLOW
- RO RED ORANGE
- RR RUSTY RED
- SB SOFT BLUE
- SD SAND
- TC TERRACOTTA
- TP TAUPE

#### 4. Options

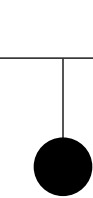

**Polished Aluminum**

- AL POLISHED ALUMINUM

**Wood Finish +224**

- 81 WHITE OAK
- 83 NATURAL MAPLE
- 85 WALNUT

**Custom Color Match**

- 09 CUSTOM COLOR

Per order per color - 20 chair minimum.  
Contact customer service for details.

#### 4. Options

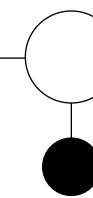

**Ganging**

- SG GANGING **+53**

Used to connect chairs to adjacent chairs or benches.

**Power**

- IN-SEAT POWER  
C1X PORT W/10' CORD **+452**
- IN-SEAT POWER  
C2X PORT W/20' CORD **+485**

See [page 7](#) for power port spec info.

#### Power Port Finish

Power ports can be finished in any standard powder coat available.

#### 5. Upholstery Style

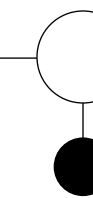

**Upholstery Style**

- U1 MONO-COLOR WATERLINE
- U2 DUAL-COLOR WATERLINE
- U3 SEAT & BACK, NO WATERLINE
- U4 SEAT & BACK, WITH WATERLINE
- U8 TRI-COLOR - SEAT, BACK & WATERLINE

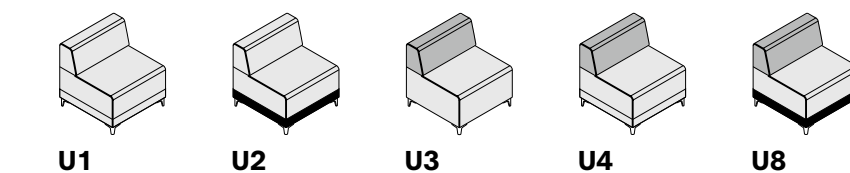

When pricing models with more than one fabric, the higher grade fabric will determine the overall grade of the specific product.

#### 6. Upholstery

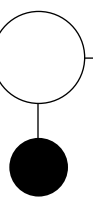

**Upholstery**

See [general information section](#) for details on textile program and COM/COL information.

Share will develop comfort wrinkles over time. The extent of these wrinkles is determined by the fabric specified.

# Share

CHAIR: 120° CORNER, TASK HEIGHT

## Textile Upholstery Grades

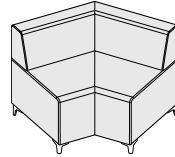
TITLE	SERIES	TYPE	SEAT	UPH	DIMENSIONS	YDG	COM	A	B	C	D	E	F	G	H	I	J	K	L	M
<b>Chair, 120° Corner, Task Height</b> 	Standard Upholstery	SH	12	48	42.5W x 28D x 29H	4.1	3,716	4,064	4,253	4,437	4,627	4,814	5,022	5,232	5,476	5,793	6,172	6,326	6,684	6,984
	Mono-Color Waterline	SH	12	48	42.5W x 28D x 29H	3.8	3,983	4,305	4,480	4,650	4,829	5,002	5,195	5,387	5,615	5,909	6,262	6,402	6,735	7,012
	Dual-Color Waterline	SH	12	48	42.5W x 28D x 29H	3.5 above Waterline 0.8 below Waterline	3,983	4,341	4,535	4,722	4,917	5,111	5,324	5,537	5,786	6,112	6,501	6,720	7,097	7,410
	No Waterline Back & Seat	SH	12	48	42.5W x 28D x 29H	1.6 Back 2.5 Seat	3,716	4,064	4,253	4,437	4,627	4,814	5,022	5,232	5,476	5,793	6,172	6,326	6,684	6,984
	Waterline Back & Seat	SH	12	48	42.5W x 28D x 29H	1.6 Back 2.5 Seat/below Waterline	3,983	4,305	4,480	4,650	4,829	5,002	5,195	5,387	5,615	5,909	6,262	6,594	6,951	7,251
	Triple-Back & Seat & Waterline	SH	12	48	42.5W x 28D x 29H	0.8 below Waterline 1.6 Back 1.9 Seat/above Waterline	3,983	4,341	4,535	4,722	4,917	5,111	5,324	5,537	5,786	6,112	6,501	6,720	7,097	7,410

### To Order Select Below

#### 1. Series/Type/Seat

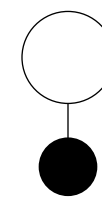

SH1248

**Share**  
Chair, 120° Corner  
Task Height

#### 2. Leg

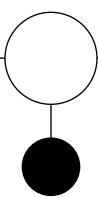

##### Leg

- L1 CORNER LEG, ADJ. PLASTIC GLIDES
- L2 ROUND LEG, ADJ. PLASTIC GLIDES
- L3 WOOD LEG

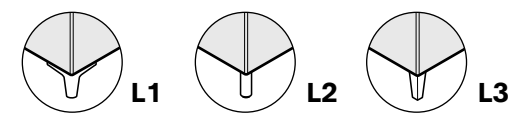

##### Mobility

The round leg glide has a larger diameter (1") than the corner leg for easier sliding on low pile carpet. Stylex is not responsible for damage to carpeting or floors.

#### 3. Leg Finish

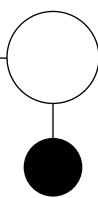

##### Standard Powder Coated Metal

- BL BLUE
- BM BLACK MATTE
- CP CHAMPAGNE
- DB DARK BRONZE
- DG DARK GRAY
- DP DUSTY PINK
- DS DARK SAGE
- LG LIGHT GRAY
- LL LILAC GRAY
- LP LIGHT PISTACHIO
- LR LIPSTICK RED
- MB MIDNIGHT BLUE

- MG MEADOW GREEN
- MK MILK
- MS METALLIC SILVER
- NK NICKEL
- OC OCHRE
- PY PALE YELLOW
- RO RED ORANGE
- RR RUSTY RED
- SB SOFT BLUE
- SD SAND
- TC TERRACOTTA
- TP TAUPE

#### 4. Options

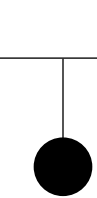

##### Polished Aluminum

- AL POLISHED ALUMINUM

##### Wood Finish +224

- 81 WHITE OAK
- 83 NATURAL MAPLE
- 85 WALNUT

##### Custom Color Match

- 09 CUSTOM COLOR

Per order per color - 20 chair minimum.  
Contact customer service for details.

#### 5. Upholstery Style

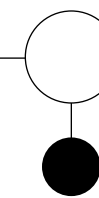

##### Ganging

- SG GANGING +53

Used to connect chairs to adjacent chairs or benches.

##### Power

- C1X IN-SEAT POWER PORT W/10' CORD +452
- C2X IN-SEAT POWER PORT W/20' CORD +485

See [page 7](#) for power port spec info.

##### Power Port Finish

Power ports can be finished in any standard powder coat available.

#### 6. Upholstery

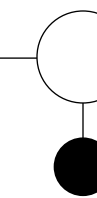

##### Upholstery Style

- U1 MONO-COLOR WATERLINE
- U2 DUAL-COLOR WATERLINE
- U3 SEAT & BACK, NO WATERLINE
- U4 SEAT & BACK, WITH WATERLINE
- U8 TRI-COLOR - SEAT, BACK & WATERLINE

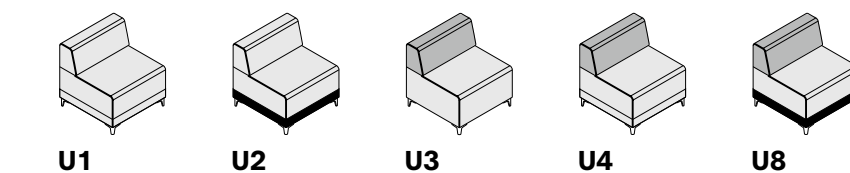

When pricing models with more than one fabric, the higher grade fabric will determine the overall grade of the specific product.

##### Upholstery

See [general information section](#) for details on textile program and COM/COL information.

Share will develop comfort wrinkles over time. The extent of these wrinkles is determined by the fabric specified.



# Share

CHAIR: 120° CORNER, BANQUETTE HEIGHT

## Textile Upholstery Grades

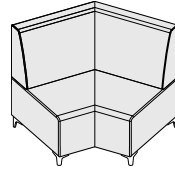
TITLE	SERIES	TYPE	SEAT	UPH	DIMENSIONS	YDG	COM	A	B	C	D	E	F	G	H	I	J	K	L	M	
 <b>Chair, 120° Corner, Banquette Height</b>	Standard Upholstery	SH	72	48	42.5W x 28D x 36H	5	4,314	4,735	4,967	5,191	5,423	5,652	5,906	6,160	6,457	6,845	7,307	7,770	8,223	8,560	
	Mono-Color Waterline	SH	72	48	U1	42.5W x 28D x 36H	4.7	4,581	4,981	5,195	5,409	5,622	5,841	6,078	6,315	6,596	6,961	7,395	7,830	8,257	8,570
	Dual-Color Waterline	SH	72	48	U2	42.5W x 28D x 36H	4.4 above Waterline 0.8 below Waterline	4,581	5,021	5,261	5,495	5,735	5,975	6,239	6,502	6,812	7,214	7,695	8,173	8,649	8,997
	No Waterline Back & Seat	SH	72	48	U3	42.5W x 28D x 36H	2.5 Back 2.5 Seat	4,314	4,735	4,967	5,191	5,423	5,652	5,906	6,160	6,457	6,845	7,307	7,770	8,223	8,560
	Waterline Back & Seat	SH	72	48	U4	42.5W x 28D x 36H	2.5 Back 2.2 Seat/below Waterline	4,581	4,981	5,195	5,409	5,622	5,841	6,078	6,315	6,596	6,961	7,395	7,830	8,257	8,570
	Triple-Back & Seat & Waterline	SH	72	48	U8	42.5W x 28D x 36H	0.8 below Waterline 2.5 Back 1.9 Seat/above Waterline	4,581	5,021	5,261	5,495	5,735	5,975	6,239	6,502	6,812	7,214	7,695	8,173	8,649	8,997

### To Order Select Below

#### 1. Series/Type/Seat

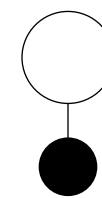

SH7248

**Share**  
**Chair, 120° Corner**  
**Banquette Height**

#### 2. Leg

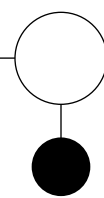

##### Leg

- L1 CORNER LEG, ADJ. PLASTIC GLIDES
- L2 ROUND LEG, ADJ. PLASTIC GLIDES
- L3 WOOD LEG

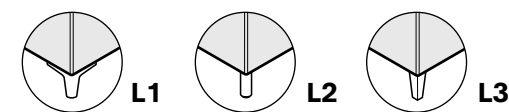

##### Mobility

The round leg glide has a larger diameter (1") than the corner leg for easier sliding on low pile carpet. Stylex is not responsible for damage to carpeting or floors.

#### 3. Leg Finish

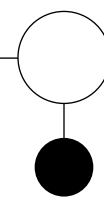

##### Standard Powder Coated Metal

- BL BLUE
- BM BLACK MATTE
- CP CHAMPAGNE
- DB DARK BRONZE
- DG DARK GRAY
- DP DUSTY PINK
- DS DARK SAGE
- LG LIGHT GRAY
- LL LILAC GRAY
- LP LIGHT PISTACHIO
- LR LIPSTICK RED
- MB MIDNIGHT BLUE

- MG MEADOW GREEN
- MK MILK
- MS METALLIC SILVER
- NK NICKEL
- OC OCHRE
- PY PALE YELLOW
- RO RED ORANGE
- RR RUSTY RED
- SB SOFT BLUE
- SD SAND
- TC TERRACOTTA
- TP TAUPE

#### 4. Options

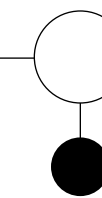

##### Ganging

- SG GANGING **+53**

Used to connect chairs to adjacent chairs or benches.

##### Power

- IN-SEAT POWER  
C1X PORT W/10' CORD **+452**
- IN-SEAT POWER  
C2X PORT W/20' CORD **+485**

See [page 7](#) for power port spec info.

##### Power Port Finish

Power ports can be finished in any standard powder coat available.

#### 5. Upholstery Style

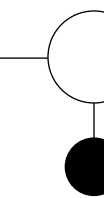

##### Upholstery Style

- U1 MONO-COLOR WATERLINE
- U2 DUAL-COLOR WATERLINE
- U3 SEAT & BACK, NO WATERLINE
- U4 SEAT & BACK, WITH WATERLINE
- U8 TRI-COLOR - SEAT, BACK & WATERLINE

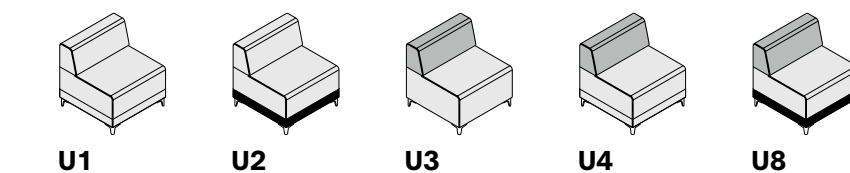

When pricing models with more than one fabric, the higher grade fabric will determine the overall grade of the specific product.

#### 6. Upholstery

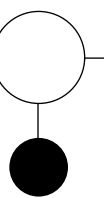

##### Upholstery

See [general information section](#) for details on textile program and COM/COL information.

Share will develop comfort wrinkles over time. The extent of these wrinkles is determined by the fabric specified.

# Share

CHAIR: 30° INSIDE CURVED, LOUNGE HEIGHT

## Textile Upholstery Grades

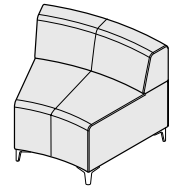
TITLE	SERIES	TYPE	SEAT	UPH	DIMENSIONS	YDG	COM	A	B	C	D	E	F	G	H	I	J	K	L	M	
 <b>Chair, 30 Inside Curved, Lounge Height</b>	Standard Upholstery	SH	14	56	35W x 28D x 29H	3.8	2,627	2,944	3,115	3,279	3,451	3,623	3,815	4,001	4,223	4,513	4,855	4,998	5,325	5,657	
	Mono-Color Waterline	SH	14	56	U1	35W x 28D x 29H	3.8	2,822	3,139	3,307	3,475	3,648	3,821	4,008	4,196	4,417	4,707	5,049	5,188	5,512	5,843
	Dual-Color Waterline	SH	14	56	U2	35W x 28D x 29H	3.3 above Waterline 0.8 below Waterline	2,822	3,163	3,348	3,530	3,713	3,900	4,103	4,308	4,545	4,855	5,226	5,382	5,735	6,091
	No Waterline Back & Seat	SH	14	56	U3	35W x 28D x 29H	1.4 Back 2.4 Seat	2,627	2,944	3,115	3,279	3,451	3,623	3,815	4,001	4,223	4,513	4,855	4,998	5,325	5,657
	Waterline Back & Seat	SH	14	56	U4	35W x 28D x 29H	1.2 Back 1.6 Seat/below Waterline	2,822	3,139	3,307	3,475	3,648	3,821	4,008	4,196	4,417	4,707	5,049	5,188	5,512	5,843
	Triple-Back & Seat & Waterline	SH	14	56	U8	35W x 28D x 29H	0.8 below Waterline 1.2 Back 1.6 Seat/above Waterline	2,822	3,163	3,348	3,530	3,713	3,900	4,103	4,308	4,545	4,855	5,226	5,382	5,735	6,091

### To Order Select Below

#### 1. Series/Type/Seat

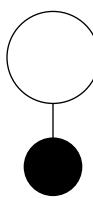

SH1456

**Share**  
Chair, 30° Inside Curved,  
Lounge Height

#### 2. Leg

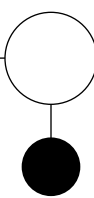

##### Leg

- L1 CORNER LEG, ADJ. PLASTIC GLIDES
- L2 ROUND LEG, ADJ. PLASTIC GLIDES
- L3 WOOD LEG

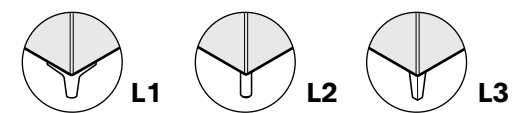

##### Mobility

The round leg glide has a larger diameter (1") than the corner leg for easier sliding on low pile carpet. Stylex is not responsible for damage to carpeting or floors.

#### 3. Leg Finish

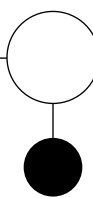

##### Standard Powder Coated Metal

- BL BLUE
- BM BLACK MATTE
- CP CHAMPAGNE
- DB DARK BRONZE
- DG DARK GRAY
- DP DUSTY PINK
- DS DARK SAGE
- LG LIGHT GRAY
- LL LILAC GRAY
- LP LIGHT PISTACHIO
- LR LIPSTICK RED
- MB MIDNIGHT BLUE

- MG MEADOW GREEN
- MK MILK
- MS METALLIC SILVER
- NK NICKEL
- OC OCHRE
- PY PALE YELLOW
- RO RED ORANGE
- RR RUSTY RED
- SB SOFT BLUE
- SD SAND
- TC TERRACOTTA
- TP TAUPE

#### 4. Options

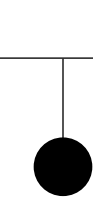

##### Polished Aluminum

- AL POLISHED ALUMINUM

##### Wood Finish +224

- 81 WHITE OAK
- 83 NATURAL MAPLE
- 85 WALNUT

##### Custom Color Match

- 09 CUSTOM COLOR

Per order per color - 20 chair minimum.  
Contact customer service for details.

#### 5. Upholstery Style

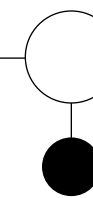

##### Ganging

- SG GANGING +53

Used to connect chairs to adjacent chairs or benches.

##### Power

- C1X IN-SEAT POWER PORT W/10' CORD +452

- C2X IN-SEAT POWER PORT W/20' CORD +485

See [page 7](#) for power port spec info.

##### Power Port Finish

Power ports can be finished in any standard powder coat available.

#### 6. Upholstery

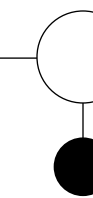

##### Upholstery Style

- U1 MONO-COLOR WATERLINE
- U2 DUAL-COLOR WATERLINE
- U3 SEAT & BACK, NO WATERLINE
- U4 SEAT & BACK, WITH WATERLINE
- U8 TRI-COLOR - SEAT, BACK & WATERLINE

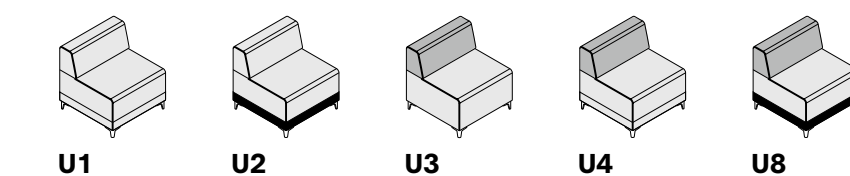

When pricing models with more than one fabric, the higher grade fabric will determine the overall grade of the specific product.

##### Upholstery

See [general information section](#) for details on textile program and COM/COL information.

Share will develop comfort wrinkles over time. The extent of these wrinkles is determined by the fabric specified.

# Share

CHAIR: 30° INSIDE CURVED, TASK HEIGHT

## Textile Upholstery Grades

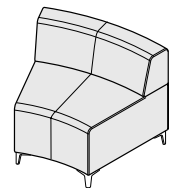
TITLE	SERIES	TYPE	SEAT	UPH	DIMENSIONS	YDG	COM	A	B	C	D	E	F	G	H	I	J	K	L	M	
 <b>Chair, 30 Inside Curved, Task Height</b>	Standard Upholstery	SH	14	58	35W x 28D x 29H	3.8	2,627	2,944	3,115	3,279	3,451	3,623	3,815	4,001	4,223	4,513	4,855	4,998	5,325	5,657	
	Mono-Color Waterline	SH	14	58	U1	35W x 28D x 29H	3.8	2,822	3,139	3,307	3,475	3,648	3,821	4,008	4,196	4,417	4,707	5,049	5,188	5,512	5,843
	Dual-Color Waterline	SH	14	58	U2	35W x 28D x 29H	3 above Waterline 0.8 below Waterline	2,822	3,139	3,307	3,475	3,648	3,821	4,008	4,196	4,417	4,707	5,049	5,188	5,512	5,843
	No Waterline Back & Seat	SH	14	58	U3	35W x 28D x 29H	1.4 Back 2.4 Seat	2,627	2,944	3,115	3,279	3,451	3,623	3,815	4,001	4,223	4,513	4,855	4,998	5,325	5,657
	Waterline Back & Seat	SH	14	58	U4	35W x 28D x 29H	1.1 Back 1.7 Seat/below Waterline	2,822	3,139	3,307	3,475	3,648	3,821	4,008	4,196	4,417	4,707	5,049	5,188	5,512	5,843
	Triple-Back & Seat & Waterline	SH	14	58	U8	35W x 28D x 29H	0.8 below Waterline 1.1 Back 1.7 Seat/above Waterline	2,822	3,139	3,307	3,475	3,648	3,821	4,008	4,196	4,417	4,707	5,049	5,188	5,512	5,843

### To Order Select Below

#### 1. Series/Type/Seat

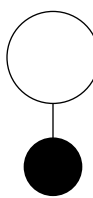

SH1458

**Share**  
Chair, 30° Inside Curved  
Task Height

#### 2. Leg

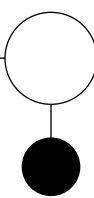

##### Leg

- L1 CORNER LEG, ADJ. PLASTIC GLIDES
- L2 ROUND LEG, ADJ. PLASTIC GLIDES
- L3 WOOD LEG

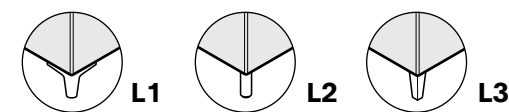

##### Mobility

The round leg glide has a larger diameter (1") than the corner leg for easier sliding on low pile carpet. Stylex is not responsible for damage to carpeting or floors.

#### 3. Leg Finish

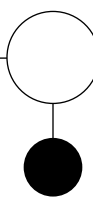

##### Standard Powder Coated Metal

- BL BLUE
- BM BLACK MATTE
- CP CHAMPAGNE
- DB DARK BRONZE
- DG DARK GRAY
- DP DUSTY PINK
- DS DARK SAGE
- LG LIGHT GRAY
- LL LILAC GRAY
- LP LIGHT PISTACHIO
- LR LIPSTICK RED
- MB MIDNIGHT BLUE

- MG MEADOW GREEN
- MK MILK
- MS METALLIC SILVER
- NK NICKEL
- OC OCHRE
- PY PALE YELLOW
- RO RED ORANGE
- RR RUSTY RED
- SB SOFT BLUE
- SD SAND
- TC TERRACOTTA
- TP TAUPE

#### 4. Options

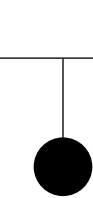

##### Polished Aluminum

- AL POLISHED ALUMINUM

##### Wood Finish +224

- 81 WHITE OAK
- 83 NATURAL MAPLE
- 85 WALNUT

##### Custom Color Match

- 09 CUSTOM COLOR

Per order per color - 20 chair minimum.  
Contact customer service for details.

#### 4. Options

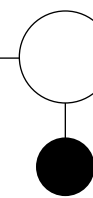

##### Ganging

- SG GANGING +53

Used to connect chairs to adjacent chairs or benches.

##### Power

- IN-SEAT POWER  
C1X PORT W/10' CORD +452

- IN-SEAT POWER  
C2X PORT W/20' CORD +485

See [page 7](#) for power port spec info.

##### Power Port Finish

Power ports can be finished in any standard powder coat available.

#### 5. Upholstery Style

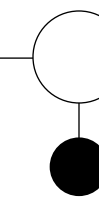

##### Upholstery Style

- U1 MONO-COLOR WATERLINE
- U2 DUAL-COLOR WATERLINE
- U3 SEAT & BACK, NO WATERLINE
- U4 SEAT & BACK, WITH WATERLINE
- U8 TRI-COLOR - SEAT, BACK & WATERLINE

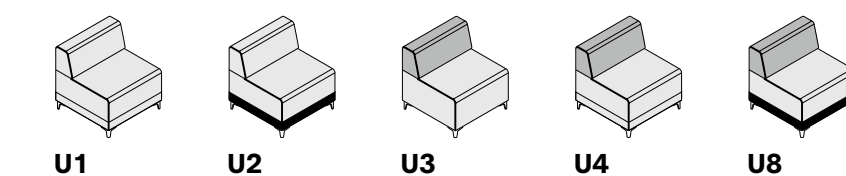

When pricing models with more than one fabric, the higher grade fabric will determine the overall grade of the specific product.

#### 6. Upholstery

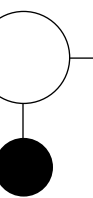

##### Upholstery

See [general information section](#) for details on textile program and COM/COL information.

Share will develop comfort wrinkles over time. The extent of these wrinkles is determined by the fabric specified.

# Share

CHAIR: 30° OUTSIDE CURVED, LOUNGE HEIGHT

## Textile Upholstery Grades

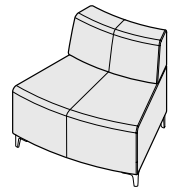
TITLE	SERIES	TYPE	SEAT	UPH	DIMENSIONS	YDG	COM	A	B	C	D	E	F	G	H	I	J	K	L	M	
 <b>Chair, 30 Outside Curved, Lounge Height</b>	Standard Upholstery	SH	15	56	35W x 28D x 29H	3.2	2,627	2,891	3,037	3,178	3,324	3,468	3,625	3,785	3,972	4,214	4,503	4,608	4,884	5,160	
	Mono-Color Waterline	SH	15	56	U1	35W x 28D x 29H	3.2	2,822	3,087	3,233	3,375	3,518	3,663	3,822	3,979	4,168	4,410	4,698	4,798	5,071	5,349
	Dual-Color Waterline	SH	15	56	U2	35W x 28D x 29H	2.7 above Waterline 0.8 below Waterline	2,822	3,115	3,271	3,425	3,583	3,742	3,915	4,088	4,293	4,557	4,874	4,993	5,293	5,596
	No Waterline Back & Seat	SH	15	56	U3	35W x 28D x 29H	1.54 Back 2.2 Seat	2,627	2,891	3,037	3,178	3,324	3,468	3,625	3,785	3,972	4,214	4,503	4,608	4,884	5,160
	Waterline Back & Seat	SH	15	56	U4	35W x 28D x 29H	1.4 Back 1.9 Seat/below Waterline	2,822	3,087	3,233	3,375	3,518	3,663	3,822	3,979	4,168	4,410	4,698	4,798	5,071	5,349
	Triple-Back & Seat & Waterline	SH	15	56	U8	35W x 28D x 29H	0.8 below Waterline 1.4 Back 1.9 Seat/above Waterline	2,822	3,115	3,271	3,425	3,583	3,742	3,915	4,088	4,293	4,557	4,874	4,993	5,293	5,596

### To Order Select Below

#### 1. Series/Type/Seat

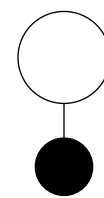

SH1556

**Share**  
Chair, 30° Outside Curved,  
Lounge Height

#### 2. Leg

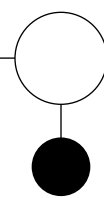

**Leg**

- L1 CORNER LEG, ADJ. PLASTIC GLIDES
- L2 ROUND LEG, ADJ. PLASTIC GLIDES
- L3 WOOD LEG

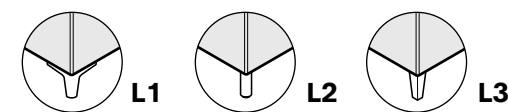

#### Mobility

The round leg glide has a larger diameter (1") than the corner leg for easier sliding on low pile carpet. Stylex is not responsible for damage to carpeting or floors.

#### 3. Leg Finish

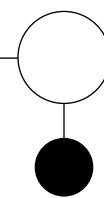

**Standard Powder Coated Metal**

- BL BLUE
- BM BLACK MATTE
- CP CHAMPAGNE
- DB DARK BRONZE
- DG DARK GRAY
- DP DUSTY PINK
- DS DARK SAGE
- LG LIGHT GRAY
- LL LILAC GRAY
- LP LIGHT PISTACHIO
- LR LIPSTICK RED
- MB MIDNIGHT BLUE

- MG MEADOW GREEN
- MK MILK
- MS METALLIC SILVER
- NK NICKEL
- OC OCHRE
- PY PALE YELLOW
- RO RED ORANGE
- RR RUSTY RED
- SB SOFT BLUE
- SD SAND
- TC TERRACOTTA
- TP TAUPE

#### 4. Options

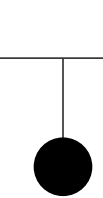

**Polished Aluminum**

- AL POLISHED ALUMINUM

**Wood Finish +224**

- 81 WHITE OAK
- 83 NATURAL MAPLE
- 85 WALNUT

**Custom Color Match**

- 09 CUSTOM COLOR

Per order per color - 20 chair minimum.  
Contact customer service for details.

#### 4. Options

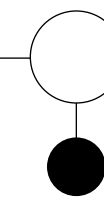

**Ganging**

- SG GANGING **+53**

Used to connect chairs to adjacent chairs or benches.

**Power**

- IN-SEAT POWER  
C1X PORT W/10' CORD **+452**
- IN-SEAT POWER  
C2X PORT W/20' CORD **+485**

See [page 7](#) for power port spec info.

#### Power Port Finish

Power ports can be finished in any standard powder coat available.

#### 5. Upholstery Style

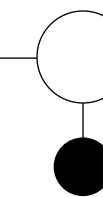

**Upholstery Style**

- U1 MONO-COLOR WATERLINE
- U2 DUAL-COLOR WATERLINE
- U3 SEAT & BACK, NO WATERLINE
- U4 SEAT & BACK, WITH WATERLINE
- U8 TRI-COLOR - SEAT, BACK & WATERLINE

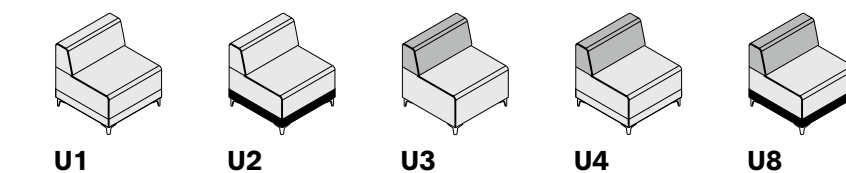

When pricing models with more than one fabric, the higher grade fabric will determine the overall grade of the specific product.

#### 6. Upholstery

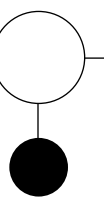

**Upholstery**

See [general information section](#) for details on textile program and COM/COL information.

Share will develop comfort wrinkles over time. The extent of these wrinkles is determined by the fabric specified.

# Share

CHAIR: 30° OUTSIDE CURVED, TASK HEIGHT

## Textile Upholstery Grades

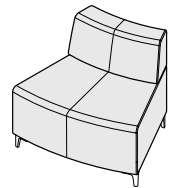
TITLE	SERIES	TYPE	SEAT	UPH	DIMENSIONS	YDG	COM	A	B	C	D	E	F	G	H	I	J	K	L	M	
 <b>Chair, 30° Outside Curved, Task Height</b>	Standard Upholstery	SH	15	58	35W x 28D x 29H	3.3	2,627	2,900	3,050	3,194	3,344	3,493	3,655	3,821	4,014	4,264	4,561	4,674	4,958	5,244	
	Mono-Color Waterline	SH	15	58	U1	35W x 28D x 29H	3.3	2,822	3,097	3,245	3,389	3,539	3,688	3,852	4,016	4,207	4,458	4,758	4,862	5,145	5,432
	Dual-Color Waterline	SH	15	58	U2	35W x 28D x 29H	2.5 above Waterline 0.8 below Waterline	2,822	3,097	3,245	3,389	3,539	3,688	3,852	4,016	4,207	4,458	4,758	4,862	5,145	5,432
	No Waterline Back & Seat	SH	15	58	U3	35W x 28D x 29H	1.54 Back 2.2 Seat	2,627	2,900	3,050	3,194	3,344	3,493	3,655	3,821	4,014	4,264	4,561	4,674	4,958	5,244
	Waterline Back & Seat	SH	15	58	U4	35W x 28D x 29H	1.4 Back 1.8 Seat/below Waterline	2,822	3,097	3,245	3,389	3,539	3,688	3,852	4,016	4,207	4,458	4,758	4,862	5,145	5,432
	Triple-Back & Seat & Waterline	SH	15	58	U8	35W x 28D x 29H	0.8 below Waterline 1.4 Back 1.8 Seat/above Waterline	2,822	3,097	3,245	3,389	3,539	3,688	3,852	4,016	4,207	4,458	4,758	4,862	5,145	5,432

### To Order Select Below

#### 1. Series/Type/Seat

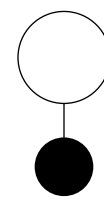

SH1558

**Share**  
**Chair, 30° Outside Curved,**  
**Task Height**

#### 2. Leg

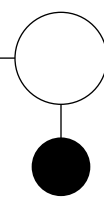

##### Leg

- L1 CORNER LEG, ADJ. PLASTIC GLIDES
- L2 ROUND LEG, ADJ. PLASTIC GLIDES
- L3 WOOD LEG

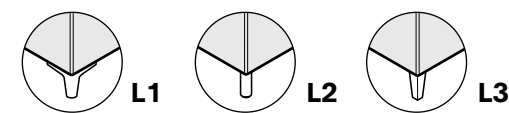

##### Mobility

The round leg glide has a larger diameter (1") than the corner leg for easier sliding on low pile carpet. Stylex is not responsible for damage to carpeting or floors.

#### 3. Leg Finish

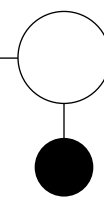

##### Standard Powder Coated Metal

- BL BLUE
- BM BLACK MATTE
- CP CHAMPAGNE
- DB DARK BRONZE
- DG DARK GRAY
- DP DUSTY PINK
- DS DARK SAGE
- LG LIGHT GRAY
- LL LILAC GRAY
- LP LIGHT PISTACHIO
- LR LIPSTICK RED
- MB MIDNIGHT BLUE

- MG MEADOW GREEN
- MK MILK
- MS METALLIC SILVER
- NK NICKEL
- OC OCHRE
- PY PALE YELLOW
- RO RED ORANGE
- RR RUSTY RED
- SB SOFT BLUE
- SD SAND
- TC TERRACOTTA
- TP TAUPE

#### 4. Options

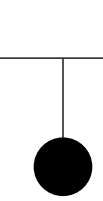

##### Polished Aluminum

- AL POLISHED ALUMINUM

##### Wood Finish +224

- 81 WHITE OAK
- 83 NATURAL MAPLE
- 85 WALNUT

##### Custom Color Match

- 09 CUSTOM COLOR

Per order per color - 20 chair minimum.  
Contact customer service for details.

#### 4. Options

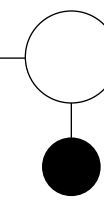

##### Ganging

- SG GANGING +53

Used to connect chairs to adjacent chairs or benches.

##### Power

- IN-SEAT POWER  
C1X PORT W/10' CORD +452
- IN-SEAT POWER  
C2X PORT W/20' CORD +485

See [page 7](#) for power port spec info.

##### Power Port Finish

Power ports can be finished in any standard powder coat available.

#### 5. Upholstery Style

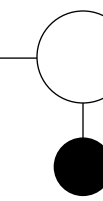

##### Upholstery Style

- U1 MONO-COLOR WATERLINE
- U2 DUAL-COLOR WATERLINE
- U3 SEAT & BACK, NO WATERLINE
- U4 SEAT & BACK, WITH WATERLINE
- U8 TRI-COLOR - SEAT, BACK & WATERLINE

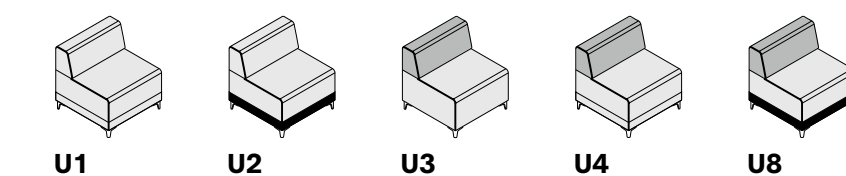

When pricing models with more than one fabric, the higher grade fabric will determine the overall grade of the specific product.

#### 6. Upholstery

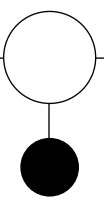

##### Upholstery

See [general information section](#) for details on textile program and COM/COL information.

Share will develop comfort wrinkles over time. The extent of these wrinkles is determined by the fabric specified.

# Share

CHAIR: 60° INSIDE CURVED, LOUNGE HEIGHT

## Textile Upholstery Grades

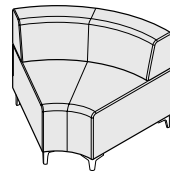
TITLE	SERIES	TYPE	SEAT	UPH	DIMENSIONS	YDG	COM	A	B	C	D	E	F	G	H	I	J	K	L	M	
 <b>Chair, 60° Inside Curved, Lounge Height</b>	Standard Upholstery	SH	14	66	39.75W x 28D x 29H	3.7	2,773	3,115	3,299	3,478	3,664	3,848	4,053	4,259	4,495	4,806	5,176	5,334	5,688	6,043	
	Mono-Color Waterline	SH	14	66	U1	39.75W x 28D x 29H	3.7	2,968	3,307	3,495	3,675	3,859	4,045	4,248	4,453	4,691	5,000	5,373	5,523	5,874	6,231
	Dual-Color Waterline	SH	14	66	U2	39.75W x 28D x 29H	3.5 above Waterline 0.8 below Waterline	2,968	3,326	3,519	3,709	3,904	4,098	4,311	4,524	4,774	5,103	5,490	5,653	6,022	6,395
	No Waterline Back & Seat	SH	14	66	U3	39.75W x 28D x 29H	1.5 Back 2.6 Seat	2,773	3,115	3,299	3,478	3,664	3,848	4,053	4,259	4,495	4,806	5,176	5,334	5,688	6,043
	Waterline Back & Seat	SH	14	66	U4	39.75W x 28D x 29H	1.1 Back 1.4 Seat/below Waterline	2,968	3,307	3,495	3,675	3,859	4,045	4,248	4,453	4,691	5,000	5,373	5,523	5,874	6,231
	Triple-Back & Seat & Waterline	SH	14	66	U8	39.75W x 28D x 29H	0.8 below Waterline 1.1 Back 1.4 Seat/above Waterline	2,968	3,326	3,519	3,709	3,904	4,098	4,311	4,524	4,774	5,103	5,490	5,653	6,022	6,395

### To Order Select Below

#### 1. Series/Type/Seat

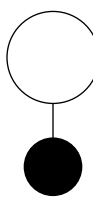

SH1466

**Share**  
Chair, 60° Inside Curved,  
Lounge Height

#### 2. Leg

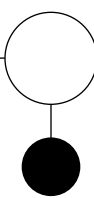

##### Leg

- L1 CORNER LEG, ADJ. PLASTIC GLIDES
- L2 ROUND LEG, ADJ. PLASTIC GLIDES
- L3 WOOD LEG

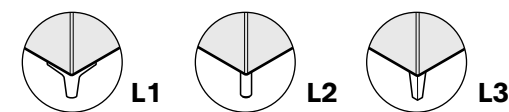

##### Mobility

The round leg glide has a larger diameter (1") than the corner leg for easier sliding on low pile carpet. Stylex is not responsible for damage to carpeting or floors.

#### 3. Leg Finish

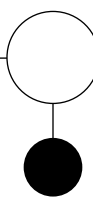

##### Standard Powder Coated Metal

- BL BLUE
- BM BLACK MATTE
- CP CHAMPAGNE
- DB DARK BRONZE
- DG DARK GRAY
- DP DUSTY PINK
- DS DARK SAGE
- LG LIGHT GRAY
- LL LILAC GRAY
- LP LIGHT PISTACHIO
- LR LIPSTICK RED
- MB MIDNIGHT BLUE

- MG MEADOW GREEN
- MK MILK
- MS METALLIC SILVER
- NK NICKEL
- OC OCHRE
- PY PALE YELLOW
- RO RED ORANGE
- RR RUSTY RED
- SB SOFT BLUE
- SD SAND
- TC TERRACOTTA
- TP TAUPE

#### 4. Options

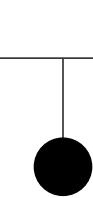

##### Polished Aluminum

- AL POLISHED ALUMINUM

##### Wood Finish +321

- 81 WHITE OAK
- 83 NATURAL MAPLE
- 85 WALNUT

##### Custom Color Match

- 09 CUSTOM COLOR

Per order per color - 20 chair minimum.  
Contact customer service for details.

#### 4. Options

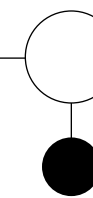

##### Ganging

- SG GANGING +53

Used to connect chairs to adjacent chairs or benches.

##### Power

- IN-SEAT POWER  
C1X PORT W/10' CORD +452
- IN-SEAT POWER  
C2X PORT W/20' CORD +485

See [page 7](#) for power port spec info.

##### Power Port Finish

Power ports can be finished in any standard powder coat available.

#### 5. Upholstery Style

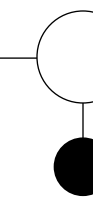

##### Upholstery Style

- U1 MONO-COLOR WATERLINE
- U2 DUAL-COLOR WATERLINE
- U3 SEAT & BACK, NO WATERLINE
- U4 SEAT & BACK, WITH WATERLINE
- U8 TRI-COLOR - SEAT, BACK & WATERLINE

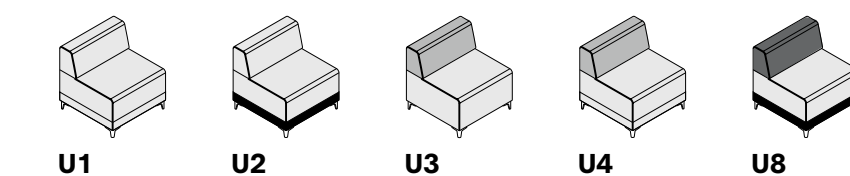

When pricing models with more than one fabric, the higher grade fabric will determine the overall grade of the specific product.

#### 6. Upholstery

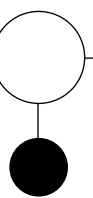

##### Upholstery

See [general information section](#) for details on textile program and COM/COL information.

Share will develop comfort wrinkles over time. The extent of these wrinkles is determined by the fabric specified.

# Share

CHAIR: 60° INSIDE CURVED, TASK HEIGHT

## Textile Upholstery Grades

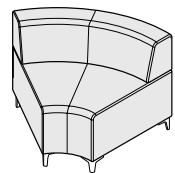
TITLE	SERIES	TYPE	SEAT	UPH	DIMENSIONS	YDG	COM	A	B	C	D	E	F	G	H	I	J	K	L	M	
<b>Chair, 60 Inside Curved, Task Height</b> 	Standard Upholstery	SH	14	68	39.75W x 28D x 29H	4.1	2,773	3,082	3,247	3,410	3,578	3,744	3,928	4,111	4,327	4,608	4,941	5,075	5,391	5,714	
	Mono-Color Waterline	SH	14	68	U1	39.75W x 28D x 29H	4.1	2,968	3,276	3,443	3,606	3,773	3,938	4,124	4,309	4,524	4,804	5,138	5,263	5,581	5,900
	Dual-Color Waterline	SH	14	68	U2	39.75W x 28D x 29H	3.8 above Waterline 0.8 below Waterline	2,968	3,350	3,558	3,760	3,968	4,177	4,405	4,633	4,900	5,250	5,665	6,081	6,491	6,908
	No Waterline Back & Seat	SH	14	68	U3	39.75W x 28D x 29H	1.3 Back 2.5 Seat	2,773	3,082	3,247	3,410	3,578	3,744	3,928	4,111	4,327	4,608	4,941	5,075	5,391	5,714
	Waterline Back & Seat	SH	14	68	U4	39.75W x 28D x 29H	1 Back 2 Seat/below Waterline	2,968	3,276	3,443	3,606	3,773	3,938	4,124	4,309	4,524	4,804	5,138	5,263	5,581	5,900
	Triple-Back & Seat & Waterline	SH	14	68	U8	39.75W x 28D x 29H	0.8 below Waterline 1 Back 2 Seat/above Waterline	2,968	3,350	3,558	3,760	3,968	4,177	4,405	4,633	4,900	5,250	5,665	6,081	6,491	6,908

### To Order Select Below

#### 1. Series/Type/Seat

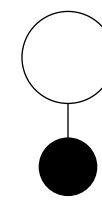

SH1468

**Share**  
Chair, 60° Inside Curved  
Task Height

#### 2. Leg

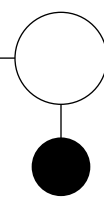

##### Leg

- L1 CORNER LEG, ADJ. PLASTIC GLIDES
- L2 ROUND LEG, ADJ. PLASTIC GLIDES
- L3 WOOD LEG

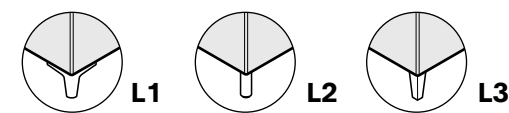

##### Mobility

The round leg glide has a larger diameter (1") than the corner leg for easier sliding on low pile carpet. Stylex is not responsible for damage to carpeting or floors.

#### 3. Leg Finish

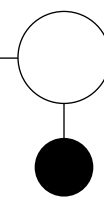

##### Standard Powder Coated Metal

- BL BLUE
- BM BLACK MATTE
- CP CHAMPAGNE
- DB DARK BRONZE
- DG DARK GRAY
- DP DUSTY PINK
- DS DARK SAGE
- LG LIGHT GRAY
- LL LILAC GRAY
- LP LIGHT PISTACHIO
- LR LIPSTICK RED
- MB MIDNIGHT BLUE

- MG MEADOW GREEN
- MK MILK
- MS METALLIC SILVER
- NK NICKEL
- OC OCHRE
- PY PALE YELLOW
- RO RED ORANGE
- RR RUSTY RED
- SB SOFT BLUE
- SD SAND
- TC TERRACOTTA
- TP TAUPE

#### 4. Options

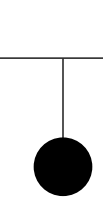

##### Polished Aluminum

- AL POLISHED ALUMINUM

##### Wood Finish +321

- 81 WHITE OAK
- 83 NATURAL MAPLE
- 85 WALNUT

##### Custom Color Match

- 09 CUSTOM COLOR

Per order per color - 20 chair minimum.  
Contact customer service for details.

#### 4. Options

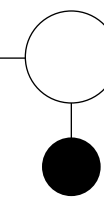

##### Ganging

- SG GANGING +53

Used to connect chairs to adjacent chairs or benches.

##### Power

- IN-SEAT POWER  
C1X PORT W/10' CORD +452
- IN-SEAT POWER  
C2X PORT W/20' CORD +485

See [page 7](#) for power port spec info.

##### Power Port Finish

Power ports can be finished in any standard powder coat available.

#### 5. Upholstery Style

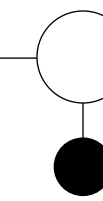

##### Upholstery Style

- U1 MONO-COLOR WATERLINE
- U2 DUAL-COLOR WATERLINE
- U3 SEAT & BACK, NO WATERLINE
- U4 SEAT & BACK, WITH WATERLINE
- U8 TRI-COLOR - SEAT, BACK & WATERLINE

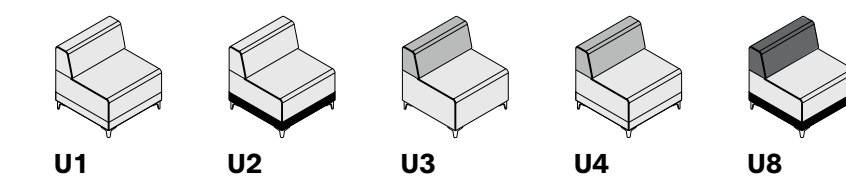

When pricing models with more than one fabric, the higher grade fabric will determine the overall grade of the specific product.

#### 6. Upholstery

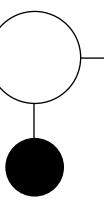

##### Upholstery

See [general information section](#) for details on textile program and COM/COL information.

Share will develop comfort wrinkles over time. The extent of these wrinkles is determined by the fabric specified.

# Share

CHAIR: 60° OUTSIDE CURVED, LOUNGE HEIGHT

## Textile Upholstery Grades

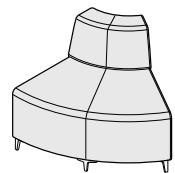
TITLE	SERIES	TYPE	SEAT	UPH	DIMENSIONS	YDG	COM	A	B	C	D	E	F	G	H	I	J	K	L	M	
<b>Chair, 60° Outside Curved, Lounge Height</b> 	Standard Upholstery	SH	15	66	39.75W x 28D x 29H	3.2	2,773	3,037	3,183	3,325	3,469	3,613	3,773	3,930	4,118	4,360	4,649	4,939	5,223	5,513	
	Mono-Color Waterline	SH	15	66	U1	39.75W x 28D x 29H	3.2	2,968	3,233	3,379	3,519	3,664	3,810	3,968	4,127	4,314	4,555	4,844	5,136	5,419	5,708
	Dual-Color Waterline	SH	15	66	U2	39.75W x 28D x 29H	2.4 above Waterline 0.8 below Waterline	2,968	3,233	3,379	3,519	3,664	3,810	3,968	4,127	4,314	4,555	4,844	5,136	5,419	5,708
	No Waterline Back & Seat	SH	15	66	U3	39.75W x 28D x 29H	1.65 Back 2.75 Seat	2,773	3,037	3,183	3,325	3,469	3,613	3,773	3,930	4,118	4,360	4,649	4,939	5,223	5,513
	Waterline Back & Seat	SH	15	66	U4	39.75W x 28D x 29H	1.5 Back 2 Seat/below Waterline	2,968	3,233	3,379	3,519	3,664	3,810	3,968	4,127	4,314	4,555	4,844	5,136	5,419	5,708
	Triple-Back & Seat & Waterline	SH	15	66	U8	39.75W x 28D x 29H	0.8 below Waterline 1.5 Back 2 Seat/above Waterline	2,968	3,233	3,379	3,519	3,664	3,810	3,968	4,127	4,314	4,555	4,844	5,136	5,419	5,708

### To Order Select Below

#### 1. Series/Type/Seat

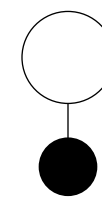

SH1566

**Share**  
Chair, 60° Outside Curved, Lounge Height

#### 2. Leg

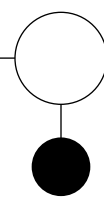

##### Leg

- L1 CORNER LEG, ADJ. PLASTIC GLIDES
- L2 ROUND LEG, ADJ. PLASTIC GLIDES
- L3 WOOD LEG

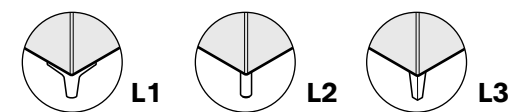

##### Mobility

The round leg glide has a larger diameter (1") than the corner leg for easier sliding on low pile carpet. Stylex is not responsible for damage to carpeting or floors.

#### 3. Leg Finish

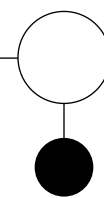

##### Standard Powder Coated Metal

- BL BLUE
- BM BLACK MATTE
- CP CHAMPAGNE
- DB DARK BRONZE
- DG DARK GRAY
- DP DUSTY PINK
- DS DARK SAGE
- LG LIGHT GRAY
- LL LILAC GRAY
- LP LIGHT PISTACHIO
- LR LIPSTICK RED
- MB MIDNIGHT BLUE

- MG MEADOW GREEN
- MK MILK
- MS METALLIC SILVER
- NK NICKEL
- OC OCHRE
- PY PALE YELLOW
- RO RED ORANGE
- RR RUSTY RED
- SB SOFT BLUE
- SD SAND
- TC TERRACOTTA
- TP TAUPE

#### 4. Options

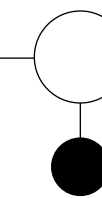

##### Ganging

- SG GANGING **+53**

Used to connect chairs to adjacent chairs or benches.

##### Power

- C1X IN-SEAT POWER PORT W/10' CORD **+452**
- C2X IN-SEAT POWER PORT W/20' CORD **+485**

See [page 7](#) for power port spec info.

##### Power Port Finish

Power ports can be finished in any standard powder coat available.

#### 5. Upholstery Style

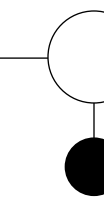

##### Upholstery Style

- U1 MONO-COLOR WATERLINE
- U2 DUAL-COLOR WATERLINE
- U3 SEAT & BACK, NO WATERLINE
- U4 SEAT & BACK, WITH WATERLINE
- U8 TRI-COLOR - SEAT, BACK & WATERLINE

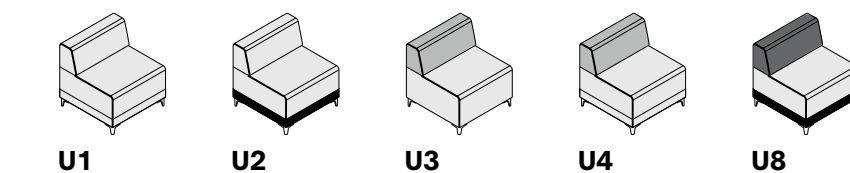

When pricing models with more than one fabric, the higher grade fabric will determine the overall grade of the specific product.

#### 6. Upholstery

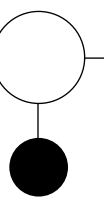

##### Upholstery

See [general information section](#) for details on textile program and COM/COL information.

Share will develop comfort wrinkles over time. The extent of these wrinkles is determined by the fabric specified.



# Share

CHAIR: 60° OUTSIDE CURVED, TASK HEIGHT

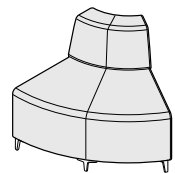
								Textile Upholstery Grades												
TITLE	SERIES	TYPE	SEAT	UPH	DIMENSIONS	YDG	COM	A	B	C	D	E	F	G	H	I	J	K	L	M
<b>Chair, 60° Outside Curved, Task Height</b> 	Standard Upholstery	SH	15	68	39.75W x 28D x 29H	3.2	2,773	3,037	3,183	3,325	3,469	3,613	3,773	3,930	4,118	4,360	4,649	4,939	5,223	5,513
	Mono-Color Waterline	SH	15	68	39.75W x 28D x 29H	3.2	2,968	3,233	3,379	3,519	3,664	3,810	3,968	4,127	4,314	4,555	4,844	5,136	5,419	5,708
	Dual-Color Waterline	SH	15	68	39.75W x 28D x 29H	2.8 above Waterline 0.8 below Waterline	2,968	3,267	3,432	3,588	3,750	3,914	4,091	4,271	4,481	4,755	5,079	5,404	5,726	6,051
	No Waterline Back & Seat	SH	15	68	39.75W x 28D x 29H	1.54 Back 2.75 Seat	2,773	3,037	3,183	3,325	3,469	3,613	3,773	3,930	4,118	4,360	4,649	4,939	5,223	5,513
	Waterline Back & Seat	SH	15	68	39.75W x 28D x 29H	1.4 Back 2.5 Seat/below Waterline	2,968	3,233	3,379	3,519	3,664	3,810	3,968	4,127	4,314	4,555	4,844	5,136	5,419	5,708
	Triple-Back & Seat & Waterline	SH	15	68	39.75W x 28D x 29H	0.8 below Waterline 1.4 Back 2.5 Seat/above Waterline	2,968	3,267	3,432	3,588	3,750	3,914	4,091	4,271	4,481	4,755	5,079	5,404	5,726	6,051

**To Order Select Below**

**1. Series/Type/Seat**



SH1568

**Share**  
Chair, 60° Outside Curved, Task Height

**2. Leg**

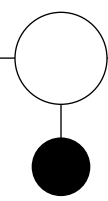

**Leg**

- L1 CORNER LEG, ADJ. PLASTIC GLIDES
- L2 ROUND LEG, ADJ. PLASTIC GLIDES
- L3 WOOD LEG

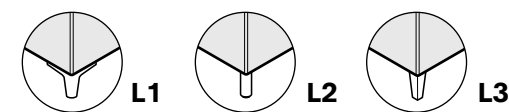

**Mobility**

The round leg glide has a larger diameter (1") than the corner leg for easier sliding on low pile carpet. Stylex is not responsible for damage to carpeting or floors.

**3. Leg Finish**

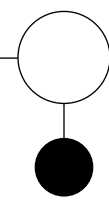

**Standard Powder Coated Metal**

- BL BLUE
- BM BLACK MATTE
- CP CHAMPAGNE
- DB DARK BRONZE
- DG DARK GRAY
- DP DUSTY PINK
- DS DARK SAGE
- LG LIGHT GRAY
- LL LILAC GRAY
- LP LIGHT PISTACHIO
- LR LIPSTICK RED
- MB MIDNIGHT BLUE

- MG MEADOW GREEN
- MK MILK
- MS METALLIC SILVER
- NK NICKEL
- OC OCHRE
- PY PALE YELLOW
- RO RED ORANGE
- RR RUSTY RED
- SB SOFT BLUE
- SD SAND
- TC TERRACOTTA
- TP TAUPE

**4. Options**

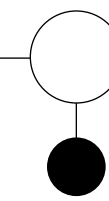

**Ganging**

- SG GANGING **+53**

Used to connect chairs to adjacent chairs or benches.

**Power**

- C1X IN-SEAT POWER PORT W/10' CORD **+452**
- C2X IN-SEAT POWER PORT W/20' CORD **+485**

See [page 7](#) for power port spec info.

**Power Port Finish**

Power ports can be finished in any standard powder coat available.

**5. Upholstery Style**

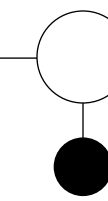

**Upholstery Style**

- U1 MONO-COLOR WATERLINE
- U2 DUAL-COLOR WATERLINE
- U3 SEAT & BACK, NO WATERLINE
- U4 SEAT & BACK, WITH WATERLINE
- U8 TRI-COLOR - SEAT, BACK & WATERLINE

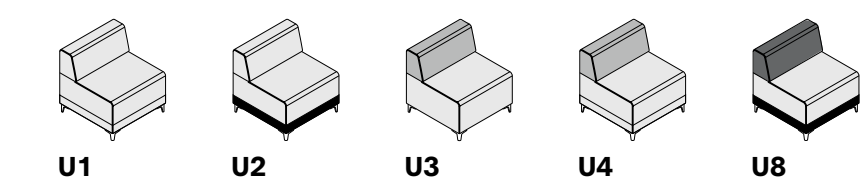

When pricing models with more than one fabric, the higher grade fabric will determine the overall grade of the specific product.

**6. Upholstery**

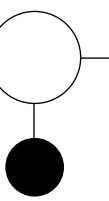

**Upholstery**

See [general information section](#) for details on textile program and COM/COL information.

Share will develop comfort wrinkles over time. The extent of these wrinkles is determined by the fabric specified.

# Share

CHAIR: 90° INSIDE CURVED, LOUNGE HEIGHT

## Textile Upholstery Grades

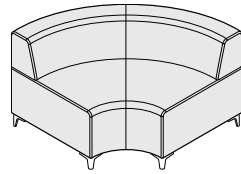
TITLE	SERIES	TYPE	SEAT	UPH	DIMENSIONS	YDG	COM	A	B	C	D	E	F	G	H	I	J	K	L	M
<b>Chair, 90° Inside Curved, Lounge Height</b> 	Standard Upholstery	SH	14	76	56.25W x 28D x 29H	5.6	3,648	4,112	4,368	4,612	4,865	5,118	5,396	5,673	6,003	6,425	6,935	7,154	7,632	8,119
	Mono-Color Waterline	SH	14	76	56.25W x 28D x 29H	5.6	3,844	4,310	4,561	4,807	5,061	5,313	5,593	5,871	6,196	6,622	7,127	7,341	7,821	8,308
	Dual-Color Waterline	SH	14	76	56.25W x 28D x 29H	5.3 above Waterline 0.8 below Waterline	3,844	4,350	4,627	4,895	5,170	5,445	5,746	6,051	6,406	6,870	7,422	7,666	8,190	8,720
	No Waterline Back & Seat	SH	14	76	56.25W x 28D x 29H	2.1 Back 3.5 Seat	3,648	4,112	4,368	4,612	4,865	5,118	5,396	5,673	6,003	6,425	6,935	7,154	7,632	8,119
	Waterline Back & Seat	SH	14	76	56.25W x 28D x 29H	1.5 Back 2.3 Seat/below Waterline	3,844	4,310	4,561	4,807	5,061	5,313	5,593	5,871	6,196	6,622	7,127	7,341	7,821	8,308
	Triple-Back & Seat & Waterline	SH	14	76	56.25W x 28D x 29H	1 below Waterline 1.5 Back 2.3 Seat/above Waterline	3,844	4,350	4,627	4,895	5,170	5,445	5,746	6,051	6,406	6,870	7,422	7,666	8,190	8,720

### To Order Select Below

#### 1. Series/Type/Seat

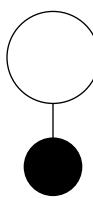

SH1476

**Share**  
Chair, 90° Inside Curved,  
Lounge Height

#### 2. Leg

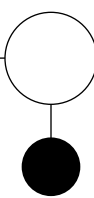

##### Leg

- L1 CORNER LEG, ADJ. PLASTIC GLIDES
- L2 ROUND LEG, ADJ. PLASTIC GLIDES
- L3 WOOD LEG

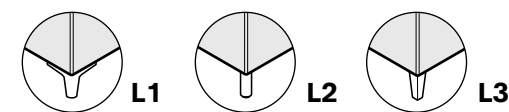

##### Mobility

The round leg glide has a larger diameter (1") than the corner leg for easier sliding on low pile carpet. Stylex is not responsible for damage to carpeting or floors.

#### 3. Leg Finish

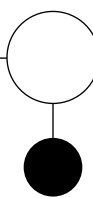

##### Standard Powder Coated Metal

- BL BLUE
- BM BLACK MATTE
- CP CHAMPAGNE
- DB DARK BRONZE
- DG DARK GRAY
- DP DUSTY PINK
- DS DARK SAGE
- LG LIGHT GRAY
- LL LILAC GRAY
- LP LIGHT PISTACHIO
- LR LIPSTICK RED
- MB MIDNIGHT BLUE

- MG MEADOW GREEN
- MK MILK
- MS METALLIC SILVER
- NK NICKEL
- OC OCHRE
- PY PALE YELLOW
- RO RED ORANGE
- RR RUSTY RED
- SB SOFT BLUE
- SD SAND
- TC TERRACOTTA
- TP TAUPE

#### 4. Options

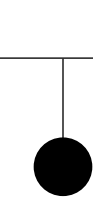

##### Polished Aluminum

- AL POLISHED ALUMINUM

##### Wood Finish +321

- 81 WHITE OAK
- 83 NATURAL MAPLE
- 85 WALNUT

##### Custom Color Match

- 09 CUSTOM COLOR

Per order per color - 20 chair minimum.  
Contact customer service for details.

#### 4. Options

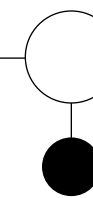

##### Ganging

- SG GANGING +53

Used to connect chairs to adjacent chairs or benches.

##### Power

- IN-SEAT POWER  
C1X PORT W/10' CORD +452
- IN-SEAT POWER  
C2X PORT W/20' CORD +485

See [page 7](#) for power port spec info.

##### Power Port Finish

Power ports can be finished in any standard powder coat available.

#### 5. Upholstery Style

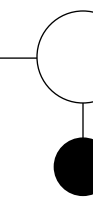

##### Upholstery Style

- U1 MONO-COLOR WATERLINE
- U2 DUAL-COLOR WATERLINE
- U3 SEAT & BACK, NO WATERLINE
- U4 SEAT & BACK, WITH WATERLINE
- U8 TRI-COLOR - SEAT, BACK & WATERLINE

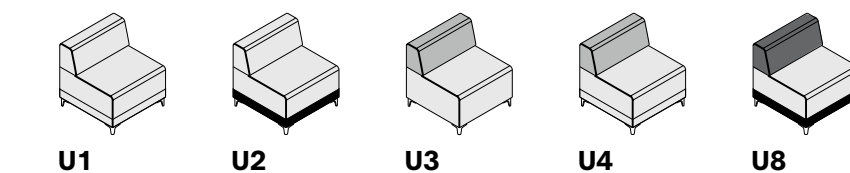

When pricing models with more than one fabric, the higher grade fabric will determine the overall grade of the specific product.

#### 6. Upholstery

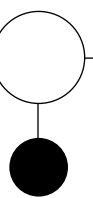

##### Upholstery

See [general information section](#) for details on textile program and COM/COL information.

Share will develop comfort wrinkles over time. The extent of these wrinkles is determined by the fabric specified.

# Share

CHAIR: 90° INSIDE CURVED, TASK HEIGHT

## Textile Upholstery Grades

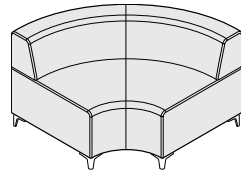
TITLE	SERIES	TYPE	SEAT	UPH	DIMENSIONS	YDG	COM	A	B	C	D	E	F	G	H	I	J	K	L	M
<b>Chair, 90° Inside Curved, Task Height</b> 	Standard Upholstery	SH	14	78	56.25W x 28D x 29H	5.6	3,648	4,112	4,368	4,612	4,865	5,118	5,396	5,673	6,003	6,425	6,935	7,154	7,632	8,119
	Mono-Color Waterline	SH	14	78	56.25W x 28D x 29H	5.6	3,844	4,310	4,561	4,807	5,061	5,313	5,593	5,871	6,196	6,622	7,127	7,341	7,821	8,308
	Dual-Color Waterline	SH	14	78	56.25W x 28D x 29H	4.8 above Waterline 0.9 below Waterline	3,844	4,317	4,577	4,826	5,081	5,341	5,624	5,906	6,241	6,671	7,185	7,407	7,894	8,389
	No Waterline Back & Seat	SH	14	78	56.25W x 28D x 29H	1.8 Back 3.5 Seat	3,648	4,112	4,368	4,612	4,865	5,118	5,396	5,673	6,003	6,425	6,935	7,154	7,632	8,119
	Waterline Back & Seat	SH	14	78	56.25W x 28D x 29H	1.3 Back 2.4 Seat/below Waterline	3,844	4,310	4,561	4,807	5,061	5,313	5,593	5,871	6,196	6,622	7,127	7,341	7,821	8,308
	Triple-Back & Seat & Waterline	SH	14	78	56.25W x 28D x 29H	1 below Waterline 1.3 Back 2.4 Seat/above Waterline	3,844	4,317	4,577	4,826	5,081	5,341	5,624	5,906	6,241	6,671	7,185	7,407	7,894	8,389

### To Order Select Below

#### 1. Series/Type/Seat

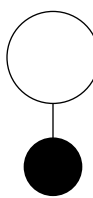

SH1478

**Share**  
Chair, 90° Inside Curved  
Task Height

#### 2. Leg

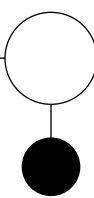

##### Leg

- L1 CORNER LEG, ADJ. PLASTIC GLIDES
- L2 ROUND LEG, ADJ. PLASTIC GLIDES
- L3 WOOD LEG

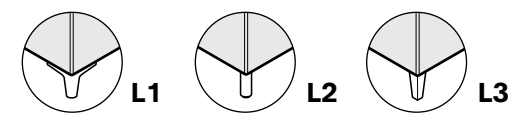

##### Mobility

The round leg glide has a larger diameter (1") than the corner leg for easier sliding on low pile carpet. Stylex is not responsible for damage to carpeting or floors.

#### 3. Leg Finish

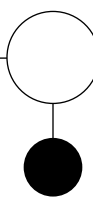

##### Standard Powder Coated Metal

- BL BLUE
- BM BLACK MATTE
- CP CHAMPAGNE
- DB DARK BRONZE
- DG DARK GRAY
- DP DUSTY PINK
- DS DARK SAGE
- LG LIGHT GRAY
- LL LILAC GRAY
- LP LIGHT PISTACHIO
- LR LIPSTICK RED
- MB MIDNIGHT BLUE

- MG MEADOW GREEN
- MK MILK
- MS METALLIC SILVER
- NK NICKEL
- OC OCHRE
- PY PALE YELLOW
- RO RED ORANGE
- RR RUSTY RED
- SB SOFT BLUE
- SD SAND
- TC TERRACOTTA
- TP TAUPE

#### 4. Options

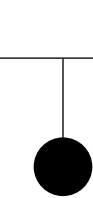

##### Polished Aluminum

- AL POLISHED ALUMINUM

##### Wood Finish +321

- 81 WHITE OAK
- 83 NATURAL MAPLE
- 85 WALNUT

##### Custom Color Match

- 09 CUSTOM COLOR

Per order per color - 20 chair minimum.  
Contact customer service for details.

#### 4. Options

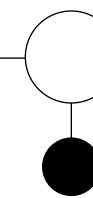

##### Ganging

- SG GANGING +53

Used to connect chairs to adjacent chairs or benches.

##### Power

- IN-SEAT POWER  
C1X PORT W/10' CORD +452
- IN-SEAT POWER  
C2X PORT W/20' CORD +485

See [page 7](#) for power port spec info.

##### Power Port Finish

Power ports can be finished in any standard powder coat available.

#### 5. Upholstery Style

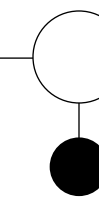

##### Upholstery Style

- U1 MONO-COLOR WATERLINE
- U2 DUAL-COLOR WATERLINE
- U3 SEAT & BACK, NO WATERLINE
- U4 SEAT & BACK, WITH WATERLINE
- U8 TRI-COLOR - SEAT, BACK & WATERLINE

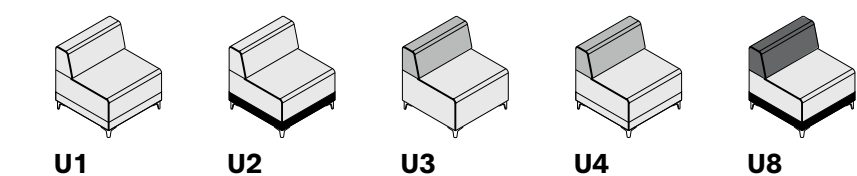

When pricing models with more than one fabric, the higher grade fabric will determine the overall grade of the specific product.

#### 6. Upholstery

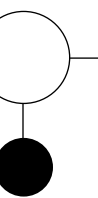

##### Upholstery

See [general information section](#) for details on textile program and COM/COL information.

Share will develop comfort wrinkles over time. The extent of these wrinkles is determined by the fabric specified.

# Share

CHAIR: 90° OUTSIDE CURVED, LOUNGE HEIGHT

## Textile Upholstery Grades

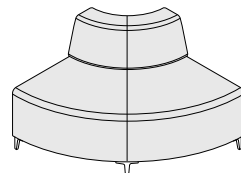
TITLE	SERIES	TYPE	SEAT	UPH	DIMENSIONS	YDG	COM	A	B	C	D	E	F	G	H	I	J	K	L	M
<b>Chair, 90° Outside Curved, Lounge Height</b> 	Standard Upholstery	SH	15	76	56.25W x 28D x 29H	4.5	3,209	3,584	3,788	3,986	4,190	4,393	4,616	4,839	5,103	5,443	5,849	6,256	6,658	7,066
	Mono-Color Waterline	SH	15	76	56.25W x 28D x 29H	4.5	3,473	3,847	4,052	4,248	4,453	4,656	4,878	5,103	5,364	5,705	6,112	6,520	6,920	7,329
	Dual-Color Waterline	SH	15	76	56.25W x 28D x 29H	3.8 above Waterline 1 below Waterline	3,473	3,872	4,088	4,299	4,516	4,733	4,972	5,210	5,488	5,854	6,290	6,722	7,150	7,584
	No Waterline Back & Seat	SH	15	76	56.25W x 28D x 29H	2.53 Back 3.3 Seat	3,209	3,584	3,788	3,986	4,190	4,393	4,616	4,839	5,103	5,443	5,849	6,256	6,658	7,066
	Waterline Back & Seat	SH	15	76	56.25W x 28D x 29H	2.3 Back 3 Seat/below Waterline	3,473	3,847	4,052	4,248	4,453	4,656	4,878	5,103	5,364	5,705	6,112	6,520	6,920	7,329
	Triple-Back & Seat & Waterline	SH	15	76	56.25W x 28D x 29H	0.8 below Waterline 2.3 Back 3 Seat/above Waterline	3,473	3,872	4,088	4,299	4,516	4,733	4,972	5,210	5,488	5,854	6,290	6,722	7,150	7,584

### To Order Select Below

#### 1. Series/Type/Seat

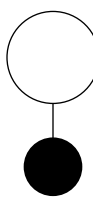

SH1576

**Share**  
Chair, 90° Outside Curved,  
Lounge Height

#### 2. Leg

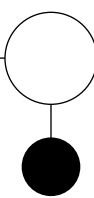

##### Leg

- L1 CORNER LEG, ADJ. PLASTIC GLIDES
- L2 ROUND LEG, ADJ. PLASTIC GLIDES
- L3 WOOD LEG

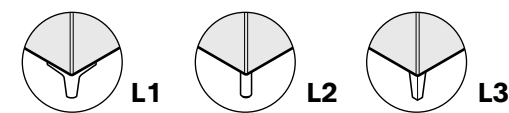

##### Mobility

The round leg glide has a larger diameter (1") than the corner leg for easier sliding on low pile carpet. Stylex is not responsible for damage to carpeting or floors.

#### 3. Leg Finish

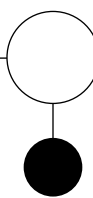

##### Standard Powder Coated Metal

- BL BLUE
- BM BLACK MATTE
- CP CHAMPAGNE
- DB DARK BRONZE
- DG DARK GRAY
- DP DUSTY PINK
- DS DARK SAGE
- LG LIGHT GRAY
- LL LILAC GRAY
- LP LIGHT PISTACHIO
- LR LIPSTICK RED
- MB MIDNIGHT BLUE

- MG MEADOW GREEN
- MK MILK
- MS METALLIC SILVER
- NK NICKEL
- OC OCHRE
- PY PALE YELLOW
- RO RED ORANGE
- RR RUSTY RED
- SB SOFT BLUE
- SD SAND
- TC TERRACOTTA
- TP TAUPE

#### 4. Options

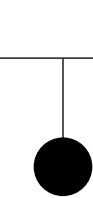

##### Polished Aluminum

- AL POLISHED ALUMINUM

##### Wood Finish +321

- 81 WHITE OAK
- 83 NATURAL MAPLE
- 85 WALNUT

##### Custom Color Match

- 09 CUSTOM COLOR

Per order per color - 20 chair minimum.  
Contact customer service for details.

#### 5. Upholstery Style

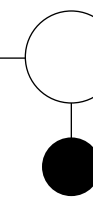

##### Ganging

- SG GANGING +53

Used to connect chairs to adjacent chairs or benches.

##### Power

- C1X IN-SEAT POWER PORT W/10' CORD +452

- C2X IN-SEAT POWER PORT W/20' CORD +485

See [page 7](#) for power port spec info.

##### Power Port Finish

Power ports can be finished in any standard powder coat available.

#### 6. Upholstery

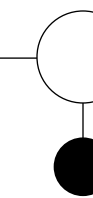

##### Upholstery Style

- U1 MONO-COLOR WATERLINE
- U2 DUAL-COLOR WATERLINE
- U3 SEAT & BACK, NO WATERLINE
- U4 SEAT & BACK, WITH WATERLINE
- U8 TRI-COLOR - SEAT, BACK & WATERLINE

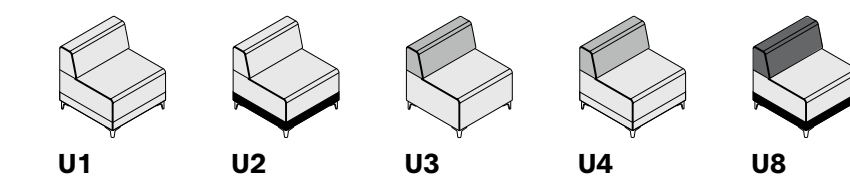

When pricing models with more than one fabric, the higher grade fabric will determine the overall grade of the specific product.

##### Upholstery

See [general information section](#) for details on textile program and COM/COL information.

Share will develop comfort wrinkles over time. The extent of these wrinkles is determined by the fabric specified.

# Share

CHAIR: 90° OUTSIDE CURVED, TASK HEIGHT

## Textile Upholstery Grades

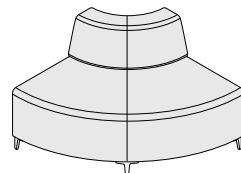
TITLE	SERIES	TYPE	SEAT	UPH	DIMENSIONS	YDG	COM	A	B	C	D	E	F	G	H	I	J	K	L	M
<b>Chair, 90° Outside Curved, Task Height</b> 	Standard Upholstery	SH	15	78	56.25W x 28D x 29H	4.5	3,209	3,584	3,788	3,986	4,190	4,393	4,616	4,839	5,103	5,443	5,849	6,256	6,658	7,066
	Mono-Color Waterline	SH	15	78	56.25W x 28D x 29H	4.5	3,473	3,847	4,052	4,248	4,453	4,656	4,878	5,103	5,364	5,705	6,112	6,520	6,920	7,329
	Dual-Color Waterline	SH	15	78	56.25W x 28D x 29H	3.7 above Waterline 1 below Waterline	3,473	3,864	4,077	4,283	4,494	4,707	4,940	5,174	5,450	5,804	6,229	6,655	7,074	7,497
	No Waterline Back & Seat	SH	15	78	56.25W x 28D x 29H	2.31 Back 3.3 Seat	3,209	3,584	3,788	3,986	4,190	4,393	4,616	4,839	5,103	5,443	5,849	6,256	6,658	7,066
	Waterline Back & Seat	SH	15	78	56.25W x 28D x 29H	2.1 Back 2.7 Seat/below Waterline	3,473	3,847	4,052	4,248	4,453	4,656	4,878	5,103	5,364	5,705	6,112	6,520	6,920	7,329
	Triple-Back & Seat & Waterline	SH	15	78	56.25W x 28D x 29H	0.9 below Waterline 2.1 Back 2.7 Seat/above Waterline	3,473	3,864	4,077	4,283	4,494	4,707	4,940	5,174	5,450	5,804	6,229	6,655	7,074	7,497

### To Order Select Below

#### 1. Series/Type/Seat

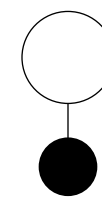

SH1578

**Share**  
Chair, 90° Outside Curved,  
Task Height

#### 2. Leg

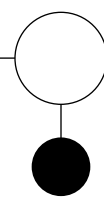

##### Leg

- L1 CORNER LEG, ADJ. PLASTIC GLIDES
- L2 ROUND LEG, ADJ. PLASTIC GLIDES
- L3 WOOD LEG

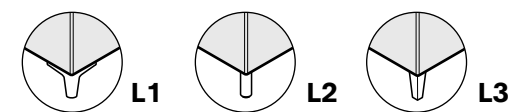

##### Mobility

The round leg glide has a larger diameter (1") than the corner leg for easier sliding on low pile carpet. Stylex is not responsible for damage to carpeting or floors.

#### 3. Leg Finish

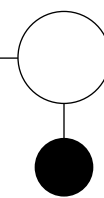

##### Standard Powder Coated Metal

- BL BLUE
- BM BLACK MATTE
- CP CHAMPAGNE
- DB DARK BRONZE
- DG DARK GRAY
- DP DUSTY PINK
- DS DARK SAGE
- LG LIGHT GRAY
- LL LILAC GRAY
- LP LIGHT PISTACHIO
- LR LIPSTICK RED
- MB MIDNIGHT BLUE

- MG MEADOW GREEN
- MK MILK
- MS METALLIC SILVER
- NK NICKEL
- OC OCHRE
- PY PALE YELLOW
- RO RED ORANGE
- RR RUSTY RED
- SB SOFT BLUE
- SD SAND
- TC TERRACOTTA
- TP TAUPE

#### 4. Options

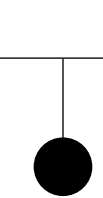

##### Polished Aluminum

- AL POLISHED ALUMINUM

##### Wood Finish +321

- 81 WHITE OAK
- 83 NATURAL MAPLE
- 85 WALNUT

##### Custom Color Match

- 09 CUSTOM COLOR

Per order per color - 20 chair minimum.  
Contact customer service for details.

#### 5. Upholstery Style

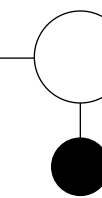

##### Ganging

- SG GANGING +53

Used to connect chairs to adjacent chairs or benches.

##### Power

- C1X IN-SEAT POWER PORT W/10' CORD +452
- C2X IN-SEAT POWER PORT W/20' CORD +485

See [page 7](#) for power port spec info.

##### Power Port Finish

Power ports can be finished in any standard powder coat available.

#### 6. Upholstery

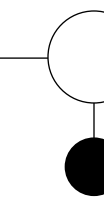

##### Upholstery Style

- U1 MONO-COLOR WATERLINE
- U2 DUAL-COLOR WATERLINE
- U3 SEAT & BACK, NO WATERLINE
- U4 SEAT & BACK, WITH WATERLINE
- U8 TRI-COLOR - SEAT, BACK & WATERLINE

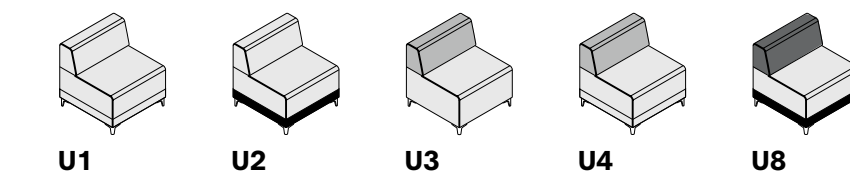

When pricing models with more than one fabric, the higher grade fabric will determine the overall grade of the specific product.

#### Upholstery

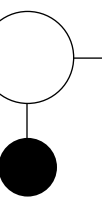

##### Upholstery

See [general information section](#) for details on textile program and COM/COL information.

Share will develop comfort wrinkles over time. The extent of these wrinkles is determined by the fabric specified.

# Share

BENCH: SINGLE-SEATER

## Textile Upholstery Grades

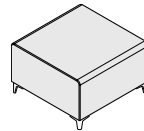
TITLE		SERIES	TYPE	SEAT	UPH	DIMENSIONS	YDG	COM	A	B	C	D	E	F	G	H	I	J	K	L	M
 <b>Bench, Single-Seater, Lounge Height</b>	Standard Upholstery	SH	01	16		28W x 28D x 16H	1.6	1,459	1,593	1,667	1,741	1,813	1,888	1,970	2,051	2,147	2,267	2,416	2,477	2,618	2,734
	Mono-Color Waterline	SH	01	16	U1	28W x 28D x 16H	1.7	1,574	1,708	1,783	1,854	1,929	2,004	2,084	2,165	2,261	2,385	2,530	2,656	2,805	2,929
	Dual-Color Waterline	SH	01	16	U2	28W x 28D x 16H	1.3 above Waterline 0.8 below Waterline	1,574	1,750	1,848	1,944	2,040	2,138	2,243	2,350	2,474	2,637	2,892	2,911	3,094	3,247
<b>Bench, Single-Seater, Task Height</b>	Standard Upholstery	SH	01	18		28W x 28D x 18H	1.6	1,459	1,603	1,681	1,757	1,837	1,915	2,003	2,088	2,187	2,318	2,474	2,477	2,618	2,734
	Mono-Color Waterline	SH	01	18	U1	28W x 28D x 18H	1.7	1,574	1,717	1,796	1,874	1,951	2,032	2,116	2,202	2,305	2,434	2,592	2,656	2,805	2,929
	Dual-Color Waterline	SH	01	18	U2	28W x 28D x 18H	1.4 above Waterline 0.8 below Waterline	1,574	1,757	1,861	1,960	2,060	2,163	2,274	2,387	2,519	2,687	2,948	2,974	3,167	3,327

### To Order Select Below

#### 1. Series/Type/Seat

SH0116  
**Share Bench, Single-Seater, Lounge Height**

---

SH0118  
**Share Bench, Single-Seater, Task Height**

#### 2. Leg

**Leg**

- L1 CORNER LEG, ADJ. PLASTIC GLIDES
- L2 ROUND LEG, ADJ. PLASTIC GLIDES
- L3 WOOD LEG

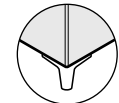
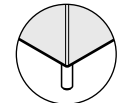
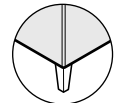
 L1
  L2
  L3

**Mobility**  
The round leg glide has a larger diameter (1") than the corner leg for easier sliding on low pile carpet. Stylex is not responsible for damage to carpeting or floors.

#### 3. Leg Finish

**Standard Powder Coated Metal**

BL BLUE	MG MEADOW GREEN
BM BLACK MATTE	MK MILK
CP CHAMPAGNE	MS METALLIC SILVER
DB DARK BRONZE	NK NICKEL
DG DARK GRAY	OC OCHRE
DP DUSTY PINK	PY PALE YELLOW
DS DARK SAGE	RO RED ORANGE
LG LIGHT GRAY	RR RUSTY RED
LL LILAC GRAY	SB SOFT BLUE
LP LIGHT PISTACHIO	SD SAND
LR LIPSTICK RED	TC TERRACOTTA
MB MIDNIGHT BLUE	TP TAUPE

#### 4. Options

**Polished Aluminum**

- AL POLISHED ALUMINUM

**Wood Finish +224**

- 81 WHITE OAK
- 83 NATURAL MAPLE
- 85 WALNUT

**Custom Color Match**

- 09 CUSTOM COLOR

Per order per color - 20 chair minimum. Contact customer service for details.

#### 4. Options

**Ganging**

- SG GANGING **+53**

Used to connect chairs to adjacent chairs or benches.

**Power**

- C1X IN-SEAT POWER PORT W/10' CORD **+452**
- C2X IN-SEAT POWER PORT W/20' CORD **+485**

See [page 7](#) for power port spec info.

**Power Port Finish**  
Power ports can be finished in any standard powder coat available.

#### 5. Upholstery Style

**Upholstery Style**

- U1 MONO-COLOR WATERLINE
- U2 DUAL-COLOR WATERLINE

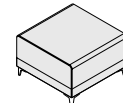
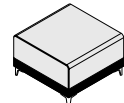
 U1
  U2

When pricing models with more than one fabric, the higher grade fabric will determine the overall grade of the specific product.

#### 6. Upholstery

**Upholstery**

**See general information section for details on textile program and COM/COL information.**

Share will develop comfort wrinkles over time. The extent of these wrinkles is determined by the fabric specified.

# Share

BENCH: TWO-SEATER

## Textile Upholstery Grades

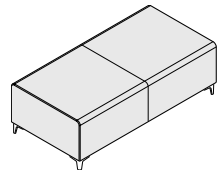
TITLE		SERIES	TYPE	SEAT	UPH	DIMENSIONS	YDG	COM	A	B	C	D	E	F	G	H	I	J	K	L	M
<b>Bench, Two-Seater, Lounge Height</b> 	Standard Upholstery	SH	01	26		56W x 28D x 16H	3.2	2,227	2,495	2,642	2,790	2,936	3,085	3,246	3,409	3,600	3,846	4,141	4,264	4,544	4,777
	Mono-Color Waterline	SH	01	26	U1	56W x 28D x 16H	3.2	2,494	2,763	2,912	3,060	3,205	3,355	3,515	3,676	3,868	4,113	4,409	4,531	4,811	5,044
	Dual-Color Waterline	SH	01	26	U2	56W x 28D x 16H	2.5 above Waterline 0.9 below Waterline	2,494	2,782	2,936	3,094	3,249	3,407	3,580	3,751	3,953	4,215	4,530	4,658	4,956	5,204
<b>Bench, Two-Seater, Task Height</b>	Standard Upholstery	SH	01	28		56W x 28D x 18H	3.4	2,227	2,512	2,669	2,827	2,980	3,139	3,312	3,482	3,687	3,948	4,260	4,391	4,688	4,937
	Mono-Color Waterline	SH	01	28	U1	56W x 28D x 18H	3.4	2,494	2,782	2,936	3,094	3,249	3,407	3,580	3,751	3,953	4,215	4,530	4,658	4,956	5,204
	Dual-Color Waterline	SH	01	28	U2	56W x 28D x 18H	2.7 above Waterline 0.9 below Waterline	2,494	2,799	2,964	3,129	3,294	3,460	3,643	3,827	4,039	4,318	4,648	4,786	5,100	5,363

### To Order Select Below

#### 1. Series/Type/Seat

SH0126

**Share Bench, Two-Seater, Lounge Height**

---

SH0128

**Share Bench, Two-Seater, Task Height**

#### 2. Leg

**Leg**

L1 CORNER LEG, ADJ. PLASTIC GLIDES

L2 ROUND LEG, ADJ. PLASTIC GLIDES

L3 WOOD LEG

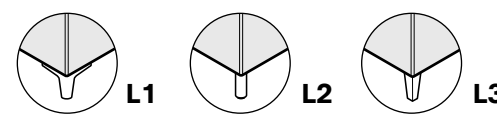

**Mobility**  
The round leg glide has a larger diameter (1") than the corner leg for easier sliding on low pile carpet. Stylex is not responsible for damage to carpeting or floors.

#### 3. Leg Finish

**Standard Powder Coated Metal**

BL BLUE

BM BLACK MATTE

CP CHAMPAGNE

DB DARK BRONZE

DG DARK GRAY

DP DUSTY PINK

DS DARK SAGE

LG LIGHT GRAY

LL LILAC GRAY

LP LIGHT PISTACHIO

LR LIPSTICK RED

MB MIDNIGHT BLUE

MG MEADOW GREEN

MK MILK

MS METALLIC SILVER

NK NICKEL

OC OCHRE

PY PALE YELLOW

RO RED ORANGE

RR RUSTY RED

SB SOFT BLUE

SD SAND

TC TERRACOTTA

TP TAUPE

#### Polished Aluminum

AL POLISHED ALUMINUM

#### Wood Finish +224

81 WHITE OAK

83 NATURAL MAPLE

85 WALNUT

#### Custom Color Match

09 CUSTOM COLOR

Per order per color - 20 chair minimum.  
Contact customer service for details.

#### 4. Options

#### Ganging

SG GANGING +53

Used to connect chairs to adjacent chairs or benches.

#### Power

C1X IN-SEAT POWER PORT W/10' CORD +452

C2X IN-SEAT POWER PORT W/20' CORD +485

See [page 7](#) for power port spec info.

#### Power Port Finish

Power ports can be finished in any standard powder coat available.

#### 5. Upholstery Style

#### Upholstery Style

U1 MONO-COLOR WATERLINE

U2 DUAL-COLOR WATERLINE

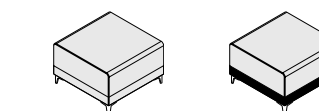

U1

U2

When pricing models with more than one fabric, the higher grade fabric will determine the overall grade of the specific product.

#### 6. Upholstery

#### Upholstery

**See general information section for details on textile program and COM/COL information.**

Share will develop comfort wrinkles over time. The extent of these wrinkles is determined by the fabric specified.

# Share

BENCH: THREE-SEATER

## Textile Upholstery Grades

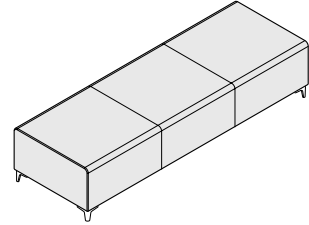
TITLE		SERIES	TYPE	SEAT	UPH	DIMENSIONS	YDG	COM	A	B	C	D	E	F	G	H	I	J	K	L	M
 <b>Bench, Three-Seater, Lounge Height</b>	Standard Upholstery	SH	01	36		84W x 28D x 16H	4.9	3,530	3,946	4,170	4,395	4,620	4,846	5,094	5,340	5,635	6,011	6,462	6,650	7,077	7,435
	Mono-Color Waterline	SH	01	36	U1	84W x 28D x 16H	4.9	3,916	4,328	4,552	4,778	5,003	5,229	5,478	5,726	6,020	6,395	6,847	7,036	7,463	7,821
	Dual-Color Waterline	SH	01	36	U2	84W x 28D x 16H	3.7 above Waterline 1.6 below Waterline	3,916	4,362	4,605	4,850	5,094	5,335	5,605	5,873	6,190	6,596	7,086	7,290	7,753	8,140
<b>Bench, Three-Seater, Task Height</b>	Standard Upholstery	SH	01	38		84W x 28D x 18H	5.2	3,530	3,970	4,207	4,447	4,687	4,925	5,190	5,453	5,765	6,162	6,642	6,840	7,295	7,674
	Mono-Color Waterline	SH	01	38	U1	84W x 28D x 18H	5.2	3,916	4,352	4,591	4,831	5,070	5,310	5,573	5,836	6,148	6,548	7,026	7,226	7,680	8,060
	Dual-Color Waterline	SH	01	38	U2	84W x 28D x 18H	4 above Waterline 1.6 below Waterline	3,916	4,388	4,645	4,904	5,159	5,416	5,700	5,985	6,321	6,750	7,265	7,481	7,971	8,379

### To Order Select Below

#### 1. Series/Type/Seat

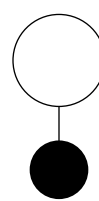

SH0136

**Share  
Bench, Three-Seater,  
Lounge Height**

SH0138

**Share  
Bench, Three-Seater,  
Task Height**

#### 2. Leg

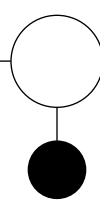

**Leg**

L1 CORNER LEG, ADJ. PLASTIC GLIDES

L2 ROUND LEG, ADJ. PLASTIC GLIDES

L3 WOOD LEG

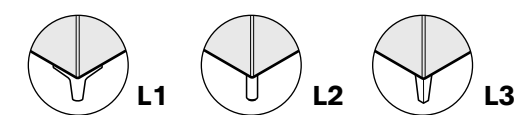

#### Mobility

The round leg glide has a larger diameter (1") than the corner leg for easier sliding on low pile carpet. Stylex is not responsible for damage to carpeting or floors.

#### 3. Leg Finish

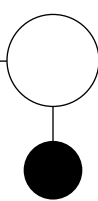

**Standard Powder Coated Metal**

BL BLUE

BM BLACK MATTE

CP CHAMPAGNE

DB DARK BRONZE

DG DARK GRAY

DP DUSTY PINK

DS DARK SAGE

LG LIGHT GRAY

LL LILAC GRAY

LP LIGHT PISTACHIO

LR LIPSTICK RED

MB MIDNIGHT BLUE

MG MEADOW GREEN

MK MILK

MS METALLIC SILVER

NK NICKEL

OC OCHRE

PY PALE YELLOW

RO RED ORANGE

RR RUSTY RED

SB SOFT BLUE

SD SAND

TC TERRACOTTA

TP TAUPE

#### 4. Options

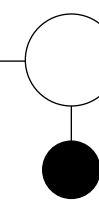

**Ganging**

SG GANGING **+53**

Used to connect chairs to adjacent chairs or benches.

**Power**

IN-SEAT POWER  
C1X PORT W/10' CORD **+452**

IN-SEAT POWER  
C2X PORT W/20' CORD **+485**

See [page 7](#) for power port spec info.

#### Power Port Finish

Power ports can be finished in any standard powder coat available.

#### 5. Upholstery Style

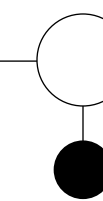

**Upholstery Style**

U1 MONO-COLOR WATERLINE

U2 DUAL-COLOR WATERLINE

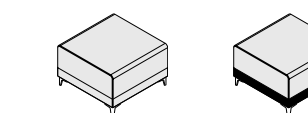

**U1**

**U2**

When pricing models with more than one fabric, the higher grade fabric will determine the overall grade of the specific product.

#### 6. Upholstery

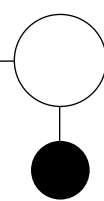

**Upholstery**

**See general information section for details on textile program and COM/COL information.**

Share will develop comfort wrinkles over time. The extent of these wrinkles is determined by the fabric specified.



# Share

BENCH: 120° CORNER

## Textile Upholstery Grades

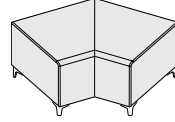
TITLE		SERIES	TYPE	SEAT	UPH	DIMENSIONS	YDG	COM	A	B	C	D	E	F	G	H	I	J	K	L	M
 <b>Bench, 120° Corner, Lounge Height</b>	Standard Upholstery	SH	02	46		42.5W x 28D x 16H	2.4	2,979	3,178	3,283	3,390	3,499	3,606	3,724	3,843	3,981	4,159	4,374	4,506	4,716	4,891
	Mono-Color Waterline	SH	02	46	U1	42.5W x 28D x 16H	2.1	3,241	3,411	3,507	3,600	3,694	3,788	3,891	3,994	4,118	4,273	4,462	4,578	4,761	4,914
	Dual-Color Waterline	SH	02	46	U2	42.5W x 28D x 16H	1.7 above Waterline 0.8 below Waterline	3,241	3,446	3,556	3,669	3,779	3,892	4,015	4,139	4,285	4,470	4,694	4,832	5,050	5,233
<b>Bench, 120° Corner, Task Height</b>	Standard Upholstery	SH	02	48		42.5W x 28D x 18H	2.5	2,979	3,184	3,297	3,408	3,519	3,631	3,755	3,879	4,023	4,208	4,432	4,570	4,788	4,971
	Mono-Color Waterline	SH	02	48	U1	42.5W x 28D x 18H	2.2	3,241	3,421	3,518	3,617	3,716	3,815	3,923	4,030	4,158	4,323	4,518	4,642	4,834	4,994
	Dual-Color Waterline	SH	02	48	U2	42.5W x 28D x 18H	1.9 above Waterline 0.8 below Waterline	3,241	3,460	3,583	3,704	3,822	3,946	4,078	4,210	4,366	4,568	4,809	4,960	5,196	5,392

### To Order Select Below

#### 1. Series/Type/Seat

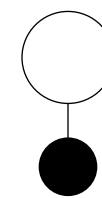

SH0246

**Share  
Bench, 120° Corner,  
Lounge Height**

SH0248

**Share  
Bench, 120° Corner,  
Task Height**

#### 2. Leg

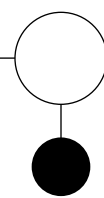

**Leg**

L1 CORNER LEG, ADJ. PLASTIC GLIDES

L2 ROUND LEG, ADJ. PLASTIC GLIDES

L3 WOOD LEG

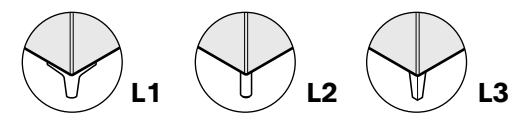

#### Mobility

The round leg glide has a larger diameter (1") than the corner leg for easier sliding on low pile carpet. Stylex is not responsible for damage to carpeting or floors.

#### 3. Leg Finish

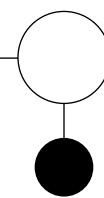

**Standard Powder Coated Metal**

BL BLUE

BM BLACK MATTE

CP CHAMPAGNE

DB DARK BRONZE

DG DARK GRAY

DP DUSTY PINK

DS DARK SAGE

LG LIGHT GRAY

LL LILAC GRAY

LP LIGHT PISTACHIO

LR LIPSTICK RED

MB MIDNIGHT BLUE

MG MEADOW GREEN

MK MILK

MS METALLIC SILVER

NK NICKEL

OC OCHRE

PY PALE YELLOW

RO RED ORANGE

RR RUSTY RED

SB SOFT BLUE

SD SAND

TC TERRACOTTA

TP TAUPE

#### 4. Options

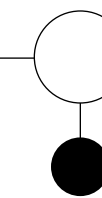

**Ganging**

SG GANGING **+53**

Used to connect chairs to adjacent chairs or benches.

**Power**

IN-SEAT POWER  
C1X PORT W/10' CORD **+452**

IN-SEAT POWER  
C2X PORT W/20' CORD **+485**

See [page 7](#) for power port spec info.

#### Power Port Finish

Power ports can be finished in any standard powder coat available.

#### 5. Upholstery Style

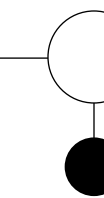

**Upholstery Style**

U1 MONO-COLOR WATERLINE

U2 DUAL-COLOR WATERLINE

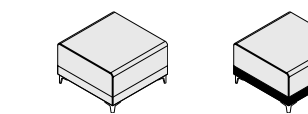

**U1**

**U2**

When pricing models with more than one fabric, the higher grade fabric will determine the overall grade of the specific product.

#### 6. Upholstery

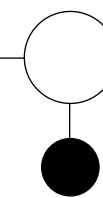

**Upholstery**

**See general information section for details on textile program and COM/COL information.**

Share will develop comfort wrinkles over time. The extent of these wrinkles is determined by the fabric specified.

# Share

BENCH: 30° INSIDE CORNER

## Textile Upholstery Grades

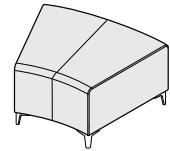
TITLE	SERIES	TYPE	SEAT	UPH	DIMENSIONS	YDG	COM	A	B	C	D	E	F	G	H	I	J	K	L	M	
 <b>Bench, 30° Inside Curved, Lounge Height</b>	Standard Upholstery	SH	04	56	35W x 28D x 16H	2.4	2,462	2,466	2,580	2,694	2,809	2,926	3,050	3,178	3,326	3,519	3,751	3,830	4,049	4,272	
	Mono-Color Waterline	SH	04	56	U1	35W x 28D x 16H	2.4	2,462	2,673	2,789	2,900	3,018	3,132	3,259	3,386	3,536	3,730	3,959	4,032	4,249	4,472
	Dual-Color Waterline	SH	04	56	U2	35W x 28D x 16H	1.9 above Waterline 0.8 below Waterline	2,462	2,701	2,833	2,956	3,085	3,217	3,360	3,503	3,668	3,888	4,145	4,238	4,484	4,734
<b>Bench, 30° Inside Curved, Task Height</b>	Standard Upholstery	SH	04	58	35W x 28D x 18H	2.4	2,462	2,466	2,580	2,694	2,809	2,926	3,050	3,178	3,326	3,519	3,751	3,830	4,049	4,272	
	Mono-Color Waterline	SH	04	58	U1	35W x 28D x 18H	2.4	2,462	2,673	2,789	2,900	3,018	3,132	3,259	3,386	3,536	3,730	3,959	4,032	4,249	4,472
	Dual-Color Waterline	SH	04	58	U2	35W x 28D x 18H	1.6 above Waterline 0.8 below Waterline	2,462	2,673	2,789	2,900	3,018	3,132	3,259	3,386	3,536	3,730	3,959	4,032	4,249	4,472

### To Order Select Below

#### 1. Series/Type/Seat

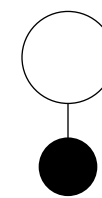

SH0456

**Share**  
**Bench, 30° Inside Curved, Lounge Height**

SH0458

**Share**  
**Bench, 30° Inside Curved, Task Height**

#### 2. Leg

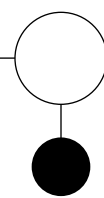

##### Leg

L1 CORNER LEG, ADJ. PLASTIC GLIDES

L2 ROUND LEG, ADJ. PLASTIC GLIDES

L3 WOOD LEG

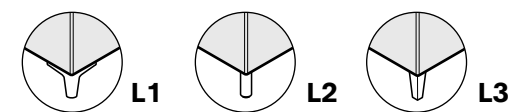

##### Mobility

The round leg glide has a larger diameter (1") than the corner leg for easier sliding on low pile carpet. Stylex is not responsible for damage to carpeting or floors.

#### 3. Leg Finish

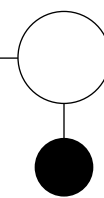

##### Standard Powder Coated Metal

BL BLUE

BM BLACK MATTE

CP CHAMPAGNE

DB DARK BRONZE

DG DARK GRAY

DP DUSTY PINK

DS DARK SAGE

LG LIGHT GRAY

LL LILAC GRAY

LP LIGHT PISTACHIO

LR LIPSTICK RED

MB MIDNIGHT BLUE

MG MEADOW GREEN

MK MILK

MS METALLIC SILVER

NK NICKEL

OC OCHRE

PY PALE YELLOW

RO RED ORANGE

RR RUSTY RED

SB SOFT BLUE

SD SAND

TC TERRACOTTA

TP TAUPE

#### 4. Options

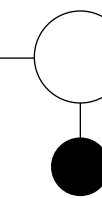

##### Ganging

SG GANGING **+53**

Used to connect chairs to adjacent chairs or benches.

##### Power

IN-SEAT POWER  
C1X PORT W/10' CORD **+452**

IN-SEAT POWER  
C2X PORT W/20' CORD **+485**

See [page 7](#) for power port spec info.

##### Power Port Finish

Power ports can be finished in any standard powder coat available.

#### 5. Upholstery Style

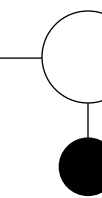

##### Upholstery Style

U1 MONO-COLOR WATERLINE

U2 DUAL-COLOR WATERLINE

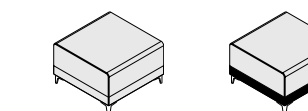

U1

U2

When pricing models with more than one fabric, the higher grade fabric will determine the overall grade of the specific product.

#### 6. Upholstery

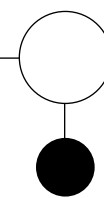

##### Upholstery

**See general information section for details on textile program and COM/COL information.**

Share will develop comfort wrinkles over time. The extent of these wrinkles is determined by the fabric specified.

# Share

BENCH: 60° INSIDE CORNER

## Textile Upholstery Grades

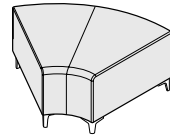
TITLE	SERIES	TYPE	SEAT	UPH	DIMENSIONS	YDG	COM	A	B	C	D	E	F	G	H	I	J	K	L	M	
 <b>Bench, 60° Inside Curved, Lounge Height</b>	Standard Upholstery	SH	04	66	39.75W x 28D x 16H	2.5	2,695	2,714	2,842	2,963	3,086	3,214	3,351	3,488	3,649	3,858	4,109	4,191	4,429	4,670	
	Mono-Color Waterline	SH	04	66	U1	39.75W x 28D x 16H	2.5	2,695	2,926	3,049	3,171	3,295	3,421	3,558	3,696	3,857	4,068	4,319	4,393	4,631	4,871
	Dual-Color Waterline	SH	04	66	U2	39.75W x 28D x 16H	2 above Waterline 0.8 below Waterline	2,695	2,944	3,076	3,207	3,342	3,478	3,625	3,773	3,948	4,172	4,445	4,532	4,787	5,046
<b>Bench, 60° Inside Curved, Task Height</b>	Standard Upholstery	SH	04	68	39.75W x 28D x 18H	2.6	2,695	2,787	2,907	3,022	3,143	3,262	3,397	3,528	3,685	3,884	4,127	4,200	4,427	4,658	
	Mono-Color Waterline	SH	04	68	U1	39.75W x 28D x 18H	2.6	2,695	2,993	3,114	3,230	3,353	3,472	3,603	3,736	3,890	4,092	4,332	4,398	4,628	4,860
	Dual-Color Waterline	SH	04	68	U2	39.75W x 28D x 18H	2.5 above Waterline 0.8 below Waterline	2,772	3,065	3,223	3,377	3,538	3,695	3,870	4,042	4,249	4,515	4,835	4,952	5,256	5,560

### To Order Select Below

#### 1. Series/Type/Seat

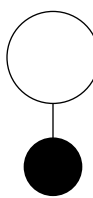

SH0466  
**Share Bench, 60° Inside Curved, Lounge Height**

SH0468  
**Share Bench, 60° Inside Curved, Task Height**

#### 2. Leg

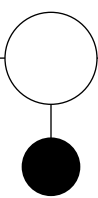

##### Leg

L1 CORNER LEG, ADJ. PLASTIC GLIDES  
L2 ROUND LEG, ADJ. PLASTIC GLIDES  
L3 WOOD LEG

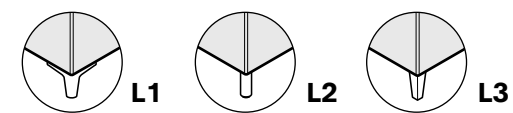

##### Mobility

The round leg glide has a larger diameter (1") than the corner leg for easier sliding on low pile carpet. Stylex is not responsible for damage to carpeting or floors.

#### 3. Leg Finish

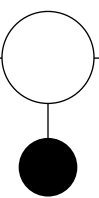

##### Standard Powder Coated Metal

BL BLUE  
BM BLACK MATTE  
CP CHAMPAGNE  
DB DARK BRONZE  
DG DARK GRAY  
DP DUSTY PINK  
DS DARK SAGE  
LG LIGHT GRAY  
LL LILAC GRAY  
LP LIGHT PISTACHIO  
LR LIPSTICK RED  
MB MIDNIGHT BLUE

MG MEADOW GREEN  
MK MILK  
MS METALLIC SILVER  
NK NICKEL  
OC OCHRE  
PY PALE YELLOW  
RO RED ORANGE  
RR RUSTY RED  
SB SOFT BLUE  
SD SAND  
TC TERRACOTTA  
TP TAUPE

##### Polished Aluminum

AL POLISHED ALUMINUM

##### Wood Finish +321

81 WHITE OAK  
83 NATURAL MAPLE  
85 WALNUT

##### Custom Color Match

09 CUSTOM COLOR

Per order per color - 20 chair minimum.  
Contact customer service for details.

#### 4. Options

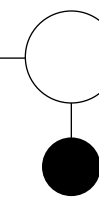

##### Ganging

SG GANGING **+53**

Used to connect chairs to adjacent chairs or benches.

##### Power

IN-SEAT POWER  
C1X PORT W/10' CORD **+452**

IN-SEAT POWER  
C2X PORT W/20' CORD **+485**

See [page 7](#) for power port spec info.

##### Power Port Finish

Power ports can be finished in any standard powder coat available.

#### 5. Upholstery Style

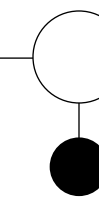

##### Upholstery Style

U1 MONO-COLOR WATERLINE  
U2 DUAL-COLOR WATERLINE

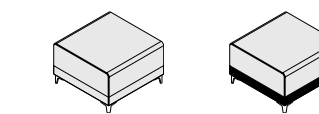

U1

U2

When pricing models with more than one fabric, the higher grade fabric will determine the overall grade of the specific product.

#### 6. Upholstery

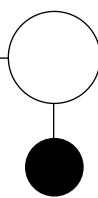

##### Upholstery

**See general information section for details on textile program and COM/COL information.**

Share will develop comfort wrinkles over time. The extent of these wrinkles is determined by the fabric specified.

# Share

BENCH: 90° INSIDE CORNER

## Textile Upholstery Grades

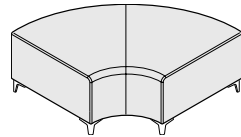
TITLE	SERIES	TYPE	SEAT	UPH	DIMENSIONS	YDG	COM	A	B	C	D	E	F	G	H	I	J	K	L	M
<b>Bench, 90 Inside Curved, Lounge Height</b> 	Standard Upholstery	SH	04	76	56.25W x 28D x 16H	3.5	3,387	3,418	3,586	3,749	3,919	4,086	4,271	4,455	4,673	4,958	5,294	5,414	5,735	6,058
	Mono-Color Waterline	SH	04	76	56.25W x 28D x 16H	3.5	3,387	3,698	3,865	4,031	4,198	4,367	4,550	4,735	4,952	5,237	5,573	5,683	6,004	6,327
	Dual-Color Waterline	SH	04	76	56.25W x 28D x 16H	3 above Waterline 0.8 below Waterline	3,387	3,726	3,906	4,082	4,265	4,449	4,651	4,851	5,088	5,396	5,762	5,891	6,238	6,592
<b>Bench, 90 Inside Curved, Task Height</b>	Standard Upholstery	SH	04	78	56.25W x 28D x 18H	3.5	3,387	3,498	3,664	3,827	3,997	4,165	4,349	4,535	4,752	5,035	5,371	5,489	5,808	6,133
	Mono-Color Waterline	SH	04	78	56.25W x 28D x 18H	3.5	3,387	3,776	3,944	4,107	4,276	4,445	4,629	4,813	5,030	5,313	5,652	5,757	6,077	6,401
	Dual-Color Waterline	SH	04	78	56.25W x 28D x 18H	2.7 above Waterline 0.8 below Waterline	3,466	3,776	3,944	4,107	4,276	4,445	4,629	4,813	5,030	5,313	5,652	5,757	6,077	6,401

### To Order Select Below

#### 1. Series/Type/Seat

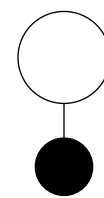

SH0476

**Share**  
**Bench, 90° Inside Curved, Lounge Height**

SH0478

**Share**  
**Bench, 90° Inside Curved, Task Height**

#### 2. Leg

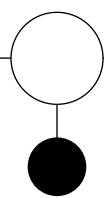

##### Leg

L1 CORNER LEG, ADJ. PLASTIC GLIDES

L2 ROUND LEG, ADJ. PLASTIC GLIDES

L3 WOOD LEG

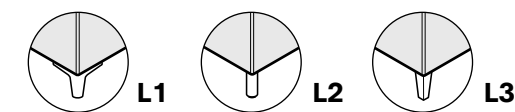

##### Mobility

The round leg glide has a larger diameter (1") than the corner leg for easier sliding on low pile carpet. Stylex is not responsible for damage to carpeting or floors.

#### 3. Leg Finish

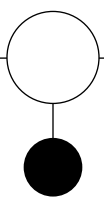

##### Standard Powder Coated Metal

BL BLUE

BM BLACK MATTE

CP CHAMPAGNE

DB DARK BRONZE

DG DARK GRAY

DP DUSTY PINK

DS DARK SAGE

LG LIGHT GRAY

LL LILAC GRAY

LP LIGHT PISTACHIO

LR LIPSTICK RED

MB MIDNIGHT BLUE

MG MEADOW GREEN

MK MILK

MS METALLIC SILVER

NK NICKEL

OC OCHRE

PY PALE YELLOW

RO RED ORANGE

RR RUSTY RED

SB SOFT BLUE

SD SAND

TC TERRACOTTA

TP TAUPE

#### 4. Options

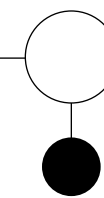

##### Ganging

SG GANGING **+53**

Used to connect chairs to adjacent chairs or benches.

##### Power

IN-SEAT POWER  
C1X PORT W/10' CORD **+452**

IN-SEAT POWER  
C2X PORT W/20' CORD **+485**

See [page 7](#) for power port spec info.

##### Power Port Finish

Power ports can be finished in any standard powder coat available.

#### 5. Upholstery Style

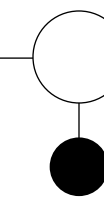

##### Upholstery Style

U1 MONO-COLOR WATERLINE

U2 DUAL-COLOR WATERLINE

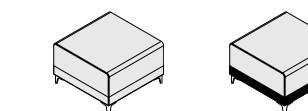

U1

U2

When pricing models with more than one fabric, the higher grade fabric will determine the overall grade of the specific product.

#### 6. Upholstery

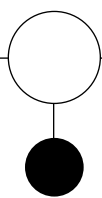

##### Upholstery

**See general information section for details on textile program and COM/COL information.**

Share will develop comfort wrinkles over time. The extent of these wrinkles is determined by the fabric specified.

# Share

BENCH: OUTSIDE CORNER

## Textile Upholstery Grades

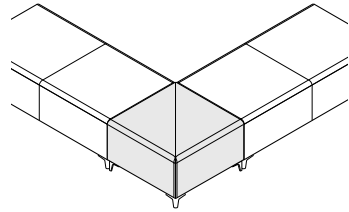
TITLE	SERIES	TYPE	SEAT	UPH	DIMENSIONS	YDG	COM	A	B	C	D	E	F	G	H	I	J	K	L	M	
<b>Bench, Outside Corner, Lounge Height</b> 	Standard Upholstery	SH	06	16	28W x 28D x 16H	2	1,459	1,629	1,720	1,811	1,903	1,996	2,096	2,198	2,317	2,470	2,657	2,731	2,907	3,036	
	Mono-Color Waterline	SH	06	16	U1	28W x 28D x 16H	2	1,574	1,744	1,835	1,925	2,017	2,111	2,211	2,313	2,432	2,584	2,771	2,841	3,018	3,146
	Dual-Color Waterline	SH	06	16	U2	28W x 28D x 16H	1.6 above Waterline 0.9 below Waterline	1,574	1,786	1,900	2,011	2,128	2,243	2,372	2,496	2,647	2,839	3,070	3,174	3,394	3,554
<b>Bench, Outside Corner, Task Height</b>	Standard Upholstery	SH	06	18	28W x 28D x 18H	2.2	1,459	1,644	1,748	1,846	1,947	2,050	2,159	2,272	2,403	2,574	2,775	2,865	3,057	3,198	
	Mono-Color Waterline	SH	06	18	U1	28W x 28D x 18H	2.2	1,574	1,759	1,863	1,960	2,060	2,163	2,274	2,387	2,519	2,687	2,891	2,975	3,167	3,309
	Dual-Color Waterline	SH	06	18	U2	28W x 28D x 18H	1.7 above Waterline 0.9 below Waterline	1,574	1,795	1,915	2,032	2,150	2,271	2,401	2,533	2,689	2,891	3,130	3,241	3,468	3,637

### To Order Select Below

#### 1. Series/Type/Seat

SH0616  
**Share Bench, Outside Corner, Lounge Height**

---

SH0618  
**Share Bench, Outside Corner, Task Height**

#### 2. Leg

**Leg**

L1 CORNER LEG, ADJ. PLASTIC GLIDES  
 L2 ROUND LEG, ADJ. PLASTIC GLIDES  
 L3 WOOD LEG

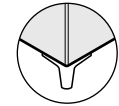
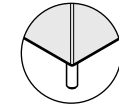
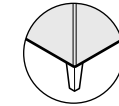
 **L1**  **L2**  **L3**

**Mobility**  
 The round leg glide has a larger diameter (1") than the corner leg for easier sliding on low pile carpet. Stylex is not responsible for damage to carpeting or floors.

#### 3. Leg Finish

**Standard Powder Coated Metal**

BL BLUE  
 BM BLACK MATTE  
 CP CHAMPAGNE  
 DB DARK BRONZE  
 DG DARK GRAY  
 DP DUSTY PINK  
 DS DARK SAGE  
 LG LIGHT GRAY  
 LL LILAC GRAY  
 LP LIGHT PISTACHIO  
 LR LIPSTICK RED  
 MB MIDNIGHT BLUE

MG MEADOW GREEN  
 MK MILK  
 MS METALLIC SILVER  
 NK NICKEL  
 OC OCHRE  
 PY PALE YELLOW  
 RO RED ORANGE  
 RR RUSTY RED  
 SB SOFT BLUE  
 SD SAND  
 TC TERRACOTTA  
 TP TAUPE

#### 4. Options

**Polished Aluminum**

AL POLISHED ALUMINUM

**Wood Finish +224**

81 WHITE OAK  
 83 NATURAL MAPLE  
 85 WALNUT

**Custom Color Match**

09 CUSTOM COLOR

Per order per color - 20 chair minimum.  
 Contact customer service for details.

#### Ganging

SG GANGING **+53**

Used to connect chairs to adjacent chairs or benches.

#### Power

IN-SEAT POWER  
 C1X PORT W/10' CORD **+452**

IN-SEAT POWER  
 C2X PORT W/20' CORD **+485**

See [page 7](#) for power port spec info.

#### Power Port Finish

Power ports can be finished in any standard powder coat available.

#### 5. Upholstery Style

**Upholstery Style**

U1 MONO-COLOR WATERLINE  
 U2 DUAL-COLOR WATERLINE

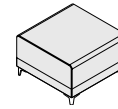
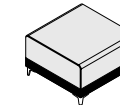
 **U1**  **U2**

When pricing models with more than one fabric, the higher grade fabric will determine the overall grade of the specific product.

#### 6. Upholstery

**Upholstery**

**See general information section for details on textile program and COM/COL information.**

Share will develop comfort wrinkles over time. The extent of these wrinkles is determined by the fabric specified.

# Share

END CAP: SINGLE NARROW

## Textile Upholstery Grades

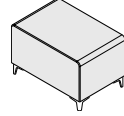
TITLE		SERIES	TYPE	SEAT	UPH	DIMENSIONS	YDG	COM	A	B	C	D	E	F	G	H	I	J	K	L	M
 <b>End Cap, Single Narrow, Lounge Height</b>	Standard Upholstery	SH	03	06		19W x 28D x 16H	1.6	1,306	1,439	1,514	1,588	1,661	1,737	1,814	1,897	1,992	2,114	2,262	2,324	2,465	2,581
	Mono-Color Waterline	SH	03	06	U1	19W x 28D x 16H	1.3	1,494	1,607	1,666	1,724	1,785	1,846	1,913	1,977	2,054	2,154	2,273	2,322	2,436	2,530
	Dual-Color Waterline	SH	03	06	U2	19W x 28D x 16H	1.3 above Waterline 0.4 below Waterline	1,494	1,640	1,717	1,797	1,874	1,952	2,038	2,124	2,228	2,357	2,513	2,577	2,726	2,850
<b>End Cap, Single Narrow, Task Height</b>	Standard Upholstery	SH	03	08		19W x 28D x 18H	1.7	1,306	1,448	1,527	1,606	1,682	1,761	1,848	1,931	2,036	2,165	2,320	2,389	2,538	2,661
	Mono-Color Waterline	SH	03	08	U1	19W x 28D x 18H	1.4	1,494	1,613	1,679	1,744	1,809	1,873	1,943	2,013	2,097	2,205	2,335	2,386	2,508	2,610
	Dual-Color Waterline	SH	03	08	U2	19W x 28D x 18H	1.4 above Waterline 0.4 below Waterline	1,494	1,649	1,731	1,813	1,897	1,979	2,071	2,161	2,270	2,408	2,574	2,641	2,798	2,929

### To Order Select Below

#### 1. Series/Type/Seat

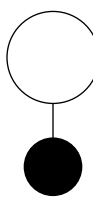

SH0306

**Share**  
End Cap, Single Narrow,  
Lounge Height

SH0308

**Share**  
End Cap, Single Narrow,  
Task Height

#### 2. Leg

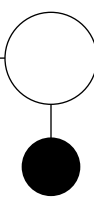

**Leg**

L1 CORNER LEG, ADJ. PLASTIC GLIDES

L2 ROUND LEG, ADJ. PLASTIC GLIDES

L3 WOOD LEG

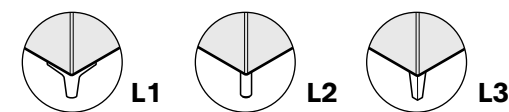

**Mobility**

The round leg glide has a larger diameter (1") than the corner leg for easier sliding on low pile carpet. Stylex is not responsible for damage to carpeting or floors.

#### 3. Leg Finish

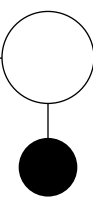

**Standard Powder Coated Metal**

BL BLUE

BM BLACK MATTE

CP CHAMPAGNE

DB DARK BRONZE

DG DARK GRAY

DP DUSTY PINK

DS DARK SAGE

LG LIGHT GRAY

LL LILAC GRAY

LP LIGHT PISTACHIO

LR LIPSTICK RED

MB MIDNIGHT BLUE

MG MEADOW GREEN

MK MILK

MS METALLIC SILVER

NK NICKEL

OC OCHRE

PY PALE YELLOW

RO RED ORANGE

RR RUSTY RED

SB SOFT BLUE

SD SAND

TC TERRACOTTA

TP TAUPE

#### 4. Options

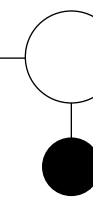

**Ganging**

SG GANGING **+53**

Used to connect chairs to adjacent chairs or benches.

**Power**

IN-SEAT POWER  
C1X PORT W/10' CORD **+452**

IN-SEAT POWER  
C2X PORT W/20' CORD **+485**

See [page 7](#) for power port spec info.

**Power Port Finish**

Power ports can be finished in any standard powder coat available.

#### 5. Upholstery Style

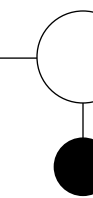

**Upholstery Style**

U1 MONO-COLOR WATERLINE

U2 DUAL-COLOR WATERLINE

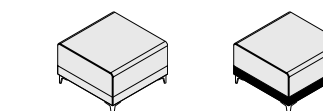

**U1**

**U2**

When pricing models with more than one fabric, the higher grade fabric will determine the overall grade of the specific product.

#### 6. Upholstery

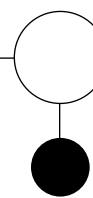

**Upholstery**

**See general information section for details on textile program and COM/COL information.**

Share will develop comfort wrinkles over time. The extent of these wrinkles is determined by the fabric specified.

# Share

END CAP: DOUBLE NARROW

## Textile Upholstery Grades

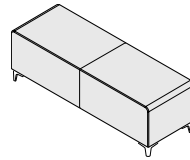
TITLE	SERIES	TYPE	SEAT	UPH	DIMENSIONS	YDG	COM	A	B	C	D	E	F	G	H	I	J	K	L	M	
 <b>End Cap, Double Narrow, Lounge Height</b>	Standard Upholstery	SH	03	16	19W x 56D x 16H	2	1,920	2,088	2,181	2,271	2,361	2,455	2,556	2,658	2,777	2,931	3,116	3,193	3,368	3,514	
	Mono-Color Waterline	SH	03	16	U1	19W x 56D x 16H	2	2,149	2,317	2,409	2,501	2,595	2,686	2,787	2,888	3,009	3,162	3,346	3,422	3,596	3,743
	Dual-Color Waterline	SH	03	16	U2	19W x 56D x 16H	1.8 above Waterline 0.8 below Waterline	2,149	2,368	2,489	2,607	2,726	2,845	2,978	3,109	3,268	3,466	3,704	3,804	4,031	4,221
<b>End Cap, Double Narrow, Task Height</b>	Standard Upholstery	SH	03	18	19W x 56D x 18H	2.1	1,920	2,095	2,192	2,288	2,386	2,484	2,585	2,695	2,820	2,980	3,174	3,257	3,440	3,593	
	Mono-Color Waterline	SH	03	18	U1	19W x 56D x 18H	2.2	2,149	2,335	2,436	2,537	2,638	2,741	2,852	2,963	3,094	3,264	3,466	3,550	3,742	3,902
	Dual-Color Waterline	SH	03	18	U2	19W x 56D x 18H	1.9 above Waterline 0.8 below Waterline	2,149	2,376	2,499	2,625	2,751	2,874	3,010	3,146	3,311	3,515	3,763	3,868	4,104	4,300

### To Order Select Below

#### 1. Series/Type/Seat



SH0316  
**Share**  
**End Cap, Double Narrow, Lounge Height**

SH0318  
**Share**  
**End Cap, Double Narrow Task Height**

#### 2. Leg

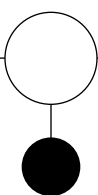

##### Leg

- L1 CORNER LEG, ADJ. PLASTIC GLIDES
- L2 ROUND LEG, ADJ. PLASTIC GLIDES
- L3 WOOD LEG

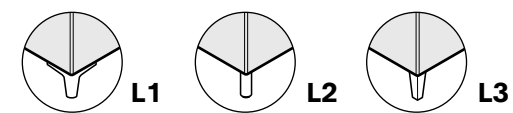

##### Mobility

The round leg glide has a larger diameter (1") than the corner leg for easier sliding on low pile carpet. Stylex is not responsible for damage to carpeting or floors.

#### 3. Leg Finish

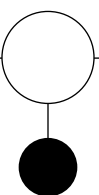

##### Standard Powder Coated Metal

- BL BLUE
- BM BLACK MATTE
- CP CHAMPAGNE
- DB DARK BRONZE
- DG DARK GRAY
- DP DUSTY PINK
- DS DARK SAGE
- LG LIGHT GRAY
- LL LILAC GRAY
- LP LIGHT PISTACHIO
- LR LIPSTICK RED
- MB MIDNIGHT BLUE

- MG MEADOW GREEN
- MK MILK
- MS METALLIC SILVER
- NK NICKEL
- OC OCHRE
- PY PALE YELLOW
- RO RED ORANGE
- RR RUSTY RED
- SB SOFT BLUE
- SD SAND
- TC TERRACOTTA
- TP TAUPE

##### Polished Aluminum

- AL POLISHED ALUMINUM

##### Wood Finish +224

- 81 WHITE OAK
- 83 NATURAL MAPLE
- 85 WALNUT

##### Custom Color Match

- 09 CUSTOM COLOR

Per order per color - 20 chair minimum.  
Contact customer service for details.

#### 4. Options

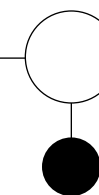

##### Ganging

- SG GANGING **+53**

Used to connect chairs to adjacent chairs or benches.

##### Power

- C1X IN-SEAT POWER PORT W/10' CORD **+452**
- C2X IN-SEAT POWER PORT W/20' CORD **+485**

See [page 7](#) for power port spec info.

##### Power Port Finish

Power ports can be finished in any standard powder coat available.

#### 5. Upholstery Style

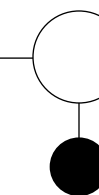

##### Upholstery Style

- U1 MONO-COLOR WATERLINE
- U2 DUAL-COLOR WATERLINE

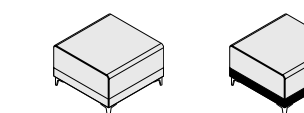

U1

U2

When pricing models with more than one fabric, the higher grade fabric will determine the overall grade of the specific product.

#### 6. Upholstery

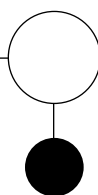

##### Upholstery

**See general information section for details on textile program and COM/COL information.**

Share will develop comfort wrinkles over time. The extent of these wrinkles is determined by the fabric specified.

# Share

END CAP: DOUBLE NARROW +

## Textile Upholstery Grades

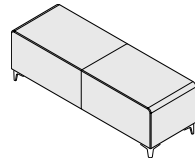
TITLE		SERIES	TYPE	SEAT	UPH	DIMENSIONS	YDG	COM	A	B	C	D	E	F	G	H	I	J	K	L	M
 <b>End Cap, Double Narrow +, Lounge Height</b>	Standard Upholstery	SH	03	26		19W x 57D x 16H	2.1	1,996	2,172	2,270	2,367	2,463	2,560	2,666	2,771	2,898	3,060	3,252	3,333	3,516	3,669
	Mono-Color Waterline	SH	03	26	U1	19W x 57D x 16H	2.1	2,227	2,401	2,497	2,596	2,693	2,789	2,895	3,005	3,127	3,287	3,482	3,564	3,747	3,900
	Dual-Color Waterline	SH	03	26	U2	19W x 57D x 16H	1.9 above Waterline 0.8 below Waterline	2,227	2,452	2,578	2,702	2,829	2,948	3,089	3,227	3,385	3,591	3,842	3,946	4,182	4,378
<b>End Cap, Double Narrow +, Task Height</b>	Standard Upholstery	SH	03	28		19W x 57D x 18H	2.1	1,996	2,172	2,270	2,367	2,463	2,560	2,666	2,771	2,898	3,060	3,252	3,333	3,516	3,669
	Mono-Color Waterline	SH	03	28	U1	19W x 57D x 18H	2.2	2,227	2,411	2,512	2,614	2,715	2,816	2,929	3,040	3,171	3,340	3,541	3,628	3,820	3,980
	Dual-Color Waterline	SH	03	28	U2	19W x 57D x 18H	1.9 above Waterline 0.8 below Waterline	2,227	2,452	2,578	2,702	2,829	2,948	3,089	3,227	3,385	3,591	3,842	3,946	4,182	4,378

### To Order Select Below

#### 1. Series/Type/Seat

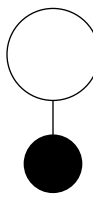

SH0326  
**Share End Cap, Double Narrow +, Lounge Height**

SH0328  
**Share End Cap, Double Narrow +, Task Height**

#### 2. Leg

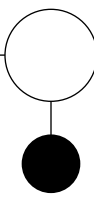

##### Leg

L1 CORNER LEG, ADJ. PLASTIC GLIDES  
L2 ROUND LEG, ADJ. PLASTIC GLIDES  
L3 WOOD LEG

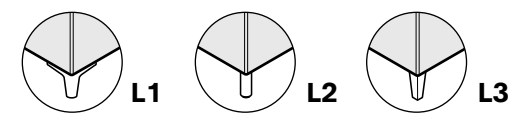

##### Mobility

The round leg glide has a larger diameter (1") than the corner leg for easier sliding on low pile carpet. Stylex is not responsible for damage to carpeting or floors.

#### 3. Leg Finish

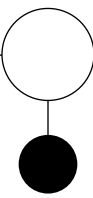

##### Standard Powder Coated Metal

BL BLUE  
BM BLACK MATTE  
CP CHAMPAGNE  
DB DARK BRONZE  
DG DARK GRAY  
DP DUSTY PINK  
DS DARK SAGE  
LG LIGHT GRAY  
LL LILAC GRAY  
LP LIGHT PISTACHIO  
LR LIPSTICK RED  
MB MIDNIGHT BLUE

MG MEADOW GREEN  
MK MILK  
MS METALLIC SILVER  
NK NICKEL  
OC OCHRE  
PY PALE YELLOW  
RO RED ORANGE  
RR RUSTY RED  
SB SOFT BLUE  
SD SAND  
TC TERRACOTTA  
TP TAUPE

#### 4. Options

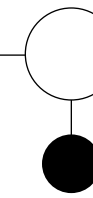

##### Ganging

SG GANGING **+53**

Used to connect chairs to adjacent chairs or benches.

##### Power

IN-SEAT POWER  
C1X PORT W/10' CORD **+452**  
IN-SEAT POWER  
C2X PORT W/20' CORD **+485**

See [page 7](#) for power port spec info.

##### Power Port Finish

Power ports can be finished in any standard powder coat available.

#### 5. Upholstery Style

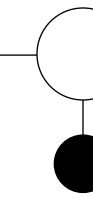

##### Upholstery Style

U1 MONO-COLOR WATERLINE  
U2 DUAL-COLOR WATERLINE

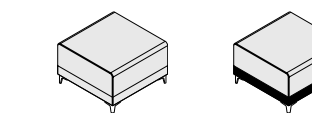

U1

U2

When pricing models with more than one fabric, the higher grade fabric will determine the overall grade of the specific product.

#### 6. Upholstery

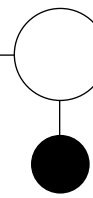

##### Upholstery

**See general information section for details on textile program and COM/COL information.**

Share will develop comfort wrinkles over time. The extent of these wrinkles is determined by the fabric specified.



# Share

END CAP: DOUBLE WIDE

## Textile Upholstery Grades

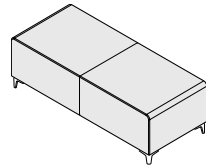
TITLE	SERIES	TYPE	SEAT	UPH	DIMENSIONS	YDG	COM	A	B	C	D	E	F	G	H	I	J	K	L	M	
<b>End Cap, Double Wide, Lounge Height</b> 	Standard Upholstery	SH	03	46	19W x 56D x 16H	2.8	2,227	2,462	2,592	2,720	2,846	2,976	3,119	3,262	3,429	3,643	3,901	4,009	4,254	4,458	
	Mono-Color Waterline	SH	03	46	U1	19W x 56D x 16H	2.4	2,494	2,696	2,805	2,918	3,027	3,139	3,261	3,381	3,525	3,712	3,931	4,022	4,232	4,406
	Dual-Color Waterline	SH	03	46	U2	19W x 56D x 16H	2 above Waterline 0.8 below Waterline	2,494	2,728	2,860	2,988	3,117	3,245	3,387	3,530	3,696	3,911	4,170	4,276	4,521	4,726
<b>End Cap, Double Wide, Task Height</b>	Standard Upholstery	SH	03	48	19W x 56D x 18H	2.9	2,227	2,468	2,604	2,737	2,870	3,006	3,151	3,298	3,470	3,692	3,960	4,073	4,326	4,538	
	Mono-Color Waterline	SH	03	48	U1	19W x 56D x 18H	2.6	2,494	2,713	2,833	2,954	3,071	3,191	3,323	3,455	3,612	3,808	4,050	4,150	4,376	4,567
	Dual-Color Waterline	SH	03	48	U2	19W x 56D x 18H	2.2 above Waterline 0.8 below Waterline	2,494	2,749	2,885	3,023	3,162	3,300	3,451	3,603	3,785	4,013	4,289	4,404	4,666	4,885

### To Order Select Below

#### 1. Series/Type/Seat

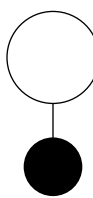

SH0346

**Share**  
End Cap, Double Wide,  
Lounge Height

SH0348

**Share**  
End Cap, Double Wide,  
Task Height

#### 2. Leg

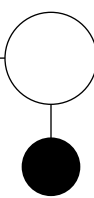

**Leg**

L1 CORNER LEG, ADJ. PLASTIC GLIDES

L2 ROUND LEG, ADJ. PLASTIC GLIDES

L3 WOOD LEG

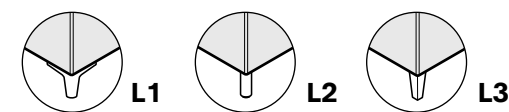

#### Mobility

The round leg glide has a larger diameter (1") than the corner leg for easier sliding on low pile carpet. Stylex is not responsible for damage to carpeting or floors.

#### 3. Leg Finish

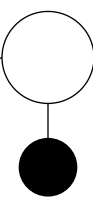

**Standard Powder Coated Metal**

BL BLUE

BM BLACK MATTE

CP CHAMPAGNE

DB DARK BRONZE

DG DARK GRAY

DP DUSTY PINK

DS DARK SAGE

LG LIGHT GRAY

LL LILAC GRAY

LP LIGHT PISTACHIO

LR LIPSTICK RED

MB MIDNIGHT BLUE

MG MEADOW GREEN

MK MILK

MS METALLIC SILVER

NK NICKEL

OC OCHRE

PY PALE YELLOW

RO RED ORANGE

RR RUSTY RED

SB SOFT BLUE

SD SAND

TC TERRACOTTA

TP TAUPE

**Polished Aluminum**

AL POLISHED ALUMINUM

**Wood Finish** +224

81 WHITE OAK

83 NATURAL MAPLE

85 WALNUT

**Custom Color Match**

09 CUSTOM COLOR

Per order per color - 20 chair minimum.  
Contact customer service for details.

#### 4. Options

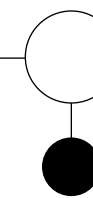

**Ganging**

SG GANGING +53

Used to connect chairs to adjacent chairs or benches.

**Power**

IN-SEAT POWER  
C1X PORT W/10' CORD +452

IN-SEAT POWER  
C2X PORT W/20' CORD +485

See [page 7](#) for power port spec info.

#### Power Port Finish

Power ports can be finished in any standard powder coat available.

#### 5. Upholstery Style

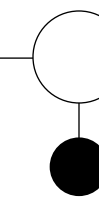

**Upholstery Style**

U1 MONO-COLOR WATERLINE

U2 DUAL-COLOR WATERLINE

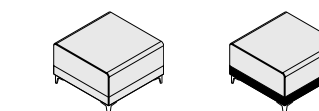

U1

U2

When pricing models with more than one fabric, the higher grade fabric will determine the overall grade of the specific product.

#### 6. Upholstery

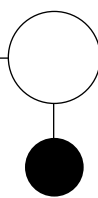

**Upholstery**

**See general information section for details on textile program and COM/COL information.**

Share will develop comfort wrinkles over time. The extent of these wrinkles is determined by the fabric specified.

# Share

END CAP: DOUBLE WIDE +

## Textile Upholstery Grades

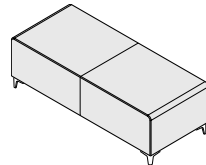
TITLE		SERIES	TYPE	SEAT	UPH	DIMENSIONS	YDG	COM	A	B	C	D	E	F	G	H	I	J	K	L	M
 <b>End Cap, Double Wide +, Lounge Height</b>	Standard Upholstery	SH	03	56		19W x 57D x 16H	2.9	2,302	2,547	2,681	2,815	2,946	3,082	3,229	3,376	3,547	3,772	4,037	4,148	4,401	4,612
	Mono-Color Waterline	SH	03	56	U1	19W x 57D x 16H	2.5	2,570	2,783	2,896	3,011	3,127	3,242	3,370	3,495	3,644	3,837	4,066	4,161	4,379	4,562
	Dual-Color Waterline	SH	03	56	U2	19W x 57D x 16H	2.1 above Waterline 0.9 below Waterline	2,570	2,825	2,963	3,100	3,238	3,377	3,529	3,681	3,859	4,091	4,365	4,480	4,742	4,961
<b>End Cap, Double Wide +, Task Height</b>	Standard Upholstery	SH	03	58		19W x 57D x 18H	3	2,302	2,554	2,694	2,832	2,971	3,106	3,261	3,411	3,588	3,821	4,098	4,212	4,474	4,692
	Mono-Color Waterline	SH	03	58	U1	19W x 57D x 18H	2.6	2,570	2,790	2,910	3,028	3,150	3,270	3,402	3,534	3,688	3,888	4,127	4,226	4,452	4,643
	Dual-Color Waterline	SH	03	58	U2	19W x 57D x 18H	2.2 above Waterline 0.9 below Waterline	2,570	2,833	2,975	3,117	3,261	3,404	3,559	3,718	3,902	4,141	4,427	4,544	4,814	5,041

### To Order Select Below

#### 1. Series/Type/Seat

SH0356

**Share**  
End Cap, Double Wide +,  
Lounge Height

---

SH0358

**Share**  
End Cap, Double Wide +,  
Task Height

#### 2. Leg

**Leg**

L1 CORNER LEG, ADJ. PLASTIC GLIDES  
L2 ROUND LEG, ADJ. PLASTIC GLIDES  
L3 WOOD LEG

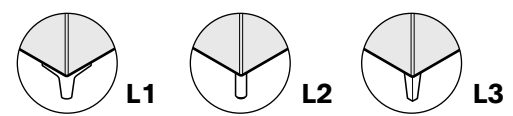

**Mobility**  
The round leg glide has a larger diameter (1") than the corner leg for easier sliding on low pile carpet. Stylex is not responsible for damage to carpeting or floors.

#### 3. Leg Finish

**Standard Powder Coated Metal**

BL BLUE  
BM BLACK MATTE  
CP CHAMPAGNE  
DB DARK BRONZE  
DG DARK GRAY  
DP DUSTY PINK  
DS DARK SAGE  
LG LIGHT GRAY  
LL LILAC GRAY  
LP LIGHT PISTACHIO  
LR LIPSTICK RED  
MB MIDNIGHT BLUE

MG MEADOW GREEN  
MK MILK  
MS METALLIC SILVER  
NK NICKEL  
OC OCHRE  
PY PALE YELLOW  
RO RED ORANGE  
RR RUSTY RED  
SB SOFT BLUE  
SD SAND  
TC TERRACOTTA  
TP TAUPE

#### 4. Options

**Polished Aluminum**

AL POLISHED ALUMINUM

**Wood Finish +224**

81 WHITE OAK  
83 NATURAL MAPLE  
85 WALNUT

**Custom Color Match**

09 CUSTOM COLOR

Per order per color - 20 chair minimum.  
Contact customer service for details.

**Ganging**

SG GANGING **+53**

Used to connect chairs to adjacent chairs or benches.

**Power**

IN-SEAT POWER  
C1X PORT W/10' CORD **+452**

IN-SEAT POWER  
C2X PORT W/20' CORD **+485**

See [page 7](#) for power port spec info.

**Power Port Finish**  
Power ports can be finished in any standard powder coat available.

#### 5. Upholstery Style

**Upholstery Style**

U1 MONO-COLOR WATERLINE  
U2 DUAL-COLOR WATERLINE

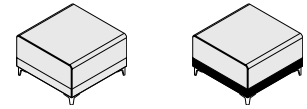

**U1**      **U2**

When pricing models with more than one fabric, the higher grade fabric will determine the overall grade of the specific product.

#### 6. Upholstery

**Upholstery**

**See general information section for details on textile program and COM/COL information.**

Share will develop comfort wrinkles over time. The extent of these wrinkles is determined by the fabric specified.

# Share

KNEE WALL: 24H

## Textile Upholstery Grades

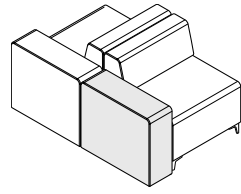
TITLE		SERIES	TYPE	SEAT	UPH	DIMENSIONS	YDG	COM	A	B	C	D	E	F	G	H	I	J	K	L	M
 <b>Knee Wall, 24 Low</b>	Standard Upholstery	SH	24	1		9W x 28D x 24H	1.6	1,076	1,208	1,283	1,356	1,431	1,502	1,586	1,667	1,761	1,884	2,034	2,095	2,235	2,351
	Mono-Color Waterline	SH	24	1	U1	9W x 28D x 24H	1.5	1,267	1,395	1,462	1,531	1,602	1,669	1,745	1,822	1,912	2,025	2,163	2,221	2,352	2,463
	Dual-Color Waterline	SH	24	1	U2	9W x 28D x 24H	0.9 above Waterline 0.6 below Waterline	1,267	1,395	1,462	1,531	1,602	1,669	1,745	1,822	1,912	2,025	2,163	2,221	2,352	2,463
<b>Knee Wall, 24 Low +</b>	Standard Upholstery	SH	24	2		9W x 28.5D x 24H	1.6	1,076	1,208	1,283	1,356	1,431	1,502	1,586	1,667	1,761	1,884	2,034	2,095	2,235	2,351
	Mono-Color Waterline	SH	24	2	U1	9W x 28.5D x 24H	1.5	1,267	1,395	1,462	1,531	1,602	1,669	1,745	1,822	1,912	2,025	2,163	2,221	2,352	2,463
	Dual-Color Waterline	SH	24	2	U2	9W x 28.5D x 24H	0.9 above Waterline 0.6 below Waterline	1,267	1,395	1,462	1,531	1,602	1,669	1,745	1,822	1,912	2,025	2,163	2,221	2,352	2,463

### To Order Select Below

#### 1. Series/Type/Seat

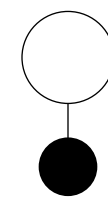

SH241

**Share**  
**Knee Wall, 24H Low**

SH242

**Share**  
**Knee Wall, 24H Low +**

#### 2. Location

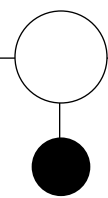

##### Location

L LEFT HAND

R RIGHT HAND

M MIDDLE

Knee walls include required ganging.  
They must be specified left, right or middle.

Location is from the seated perspective.

#### 3. Power Port

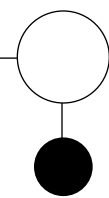

##### Power Port

P10 9' POWER CORD **+500**

P20 19' POWER CORD **+580**

**Knee Wall Flip Out Power**  
Soft Touch Anodized Cover  
1 Grounded 3-Prong  
Electrical Outlet  
1 USB 2.1A Port

#### 4. Upholstery Style

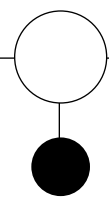

##### Upholstery Style

U1 MONO-COLOR WATERLINE

U2 DUAL-COLOR WATERLINE

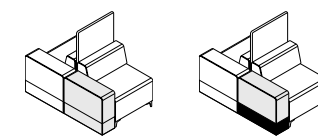

U1

U2

When pricing models with more than one fabric, the higher grade fabric will determine the overall grade of the specific product.

#### 5. Upholstery

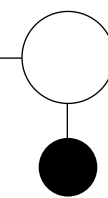

##### Upholstery

**See general information section for details on textile program and COM/COL information.**

Share will develop comfort wrinkles over time. The extent of these wrinkles is determined by the fabric specified.

# Share

KNEE WALL: 29H

## Textile Upholstery Grades

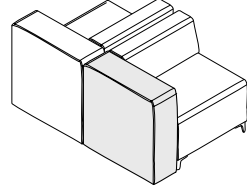
TITLE		SERIES	TYPE	SEAT	UPH	DIMENSIONS	YDG	COM	A	B	C	D	E	F	G	H	I	J	K	L	M
 <b>Knee Wall, 29 High</b>	Standard Upholstery	SH	29	1		9W x 28D x 29H	1.7	1,151	1,295	1,373	1,451	1,530	1,608	1,694	1,782	1,882	2,010	2,168	2,234	2,383	2,506
	Mono-Color Waterline	SH	29	1	U1	9W x 28D x 29H	2	1,342	1,513	1,604	1,697	1,787	1,880	1,980	2,083	2,202	2,356	2,540	2,615	2,789	2,936
	Dual-Color Waterline	SH	29	1	U2	9W x 28D x 29H	1.4 above Waterline 0.6 below Waterline	1,342	1,513	1,604	1,697	1,787	1,880	1,980	2,083	2,202	2,356	2,540	2,615	2,789	2,936
<b>Knee Wall, 29 High +</b>	Standard Upholstery	SH	29	2		9W x 28.5D x 29H	1.7	1,151	1,295	1,373	1,451	1,530	1,608	1,694	1,782	1,882	2,010	2,168	2,234	2,383	2,506
	Mono-Color Waterline	SH	29	2	U1	9W x 28.5D x 29H	2	1,342	1,513	1,604	1,697	1,787	1,880	1,980	2,083	2,202	2,356	2,540	2,615	2,789	2,936
	Dual-Color Waterline	SH	29	2	U2	9W x 28.5D x 29H	1.4 above Waterline 0.6 below Waterline	1,342	1,513	1,604	1,697	1,787	1,880	1,980	2,083	2,202	2,356	2,540	2,615	2,789	2,936

### To Order Select Below

#### 1. Series/Type/Seat

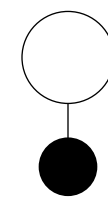

SH291

**Share**  
**Knee Wall, 29 High**

SH292

**Share**  
**Knee Wall, 29 High +**

#### 2. Location

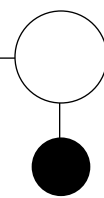

##### Location

L LEFT HAND  
R RIGHT HAND  
M MIDDLE

Knee walls include required ganging.  
They must be specified left, right or middle.

Location is from the seated perspective.

#### 3. Power Port

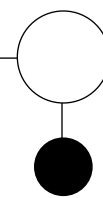

##### Power Port

P10 9' POWER CORD **+500**  
P20 19' POWER CORD **+580**

**Knee Wall Flip Out Power**  
Soft Touch Anodized Cover  
1 Grounded 3-Prong  
Electrical Outlet  
1 USB 2.1A Port

#### 4. Upholstery Style

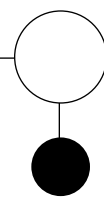

##### Upholstery Style

U1 MONO-COLOR WATERLINE  
U2 DUAL-COLOR WATERLINE

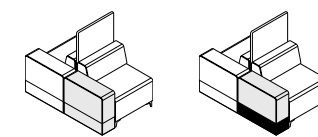

**U1**

**U2**

When pricing models with more than one fabric, the higher grade fabric will determine the overall grade of the specific product.

#### 5. Upholstery

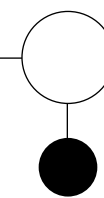

##### Upholstery

**See general information section for details on textile program and COM/COL information.**

Share will develop comfort wrinkles over time. The extent of these wrinkles is determined by the fabric specified.

# Share

## ARM

### Textile Upholstery Grades

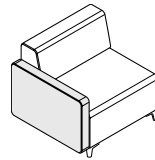
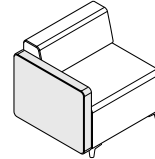
TITLE	SERIES	TYPE	SEAT	UPH	DIMENSIONS	YDG	COM	A	B	C	D	E	F	G	H	I	J	K	L	M	
	Standard Upholstery	SH	54	6	4W x 28D x 20H	2.1	446	625	722	816	914	1,009	1,117	1,224	1,350	1,512	1,706	1,826	2,009	2,146	
	Mono-Color Waterline	SH	54	6	U1	4W x 28D x 20H	1.8	625	780	861	943	1,025	1,110	1,198	1,292	1,399	1,537	1,704	1,797	1,957	2,071
	Dual-Color Waterline	SH	54	6	U2	4W x 28D x 20H	1.8 above Waterline 0.9 below Waterline	625	856	980	1,099	1,225	1,351	1,487	1,623	1,785	1,994	2,243	2,314	2,560	2,741
	Standard Upholstery	SH	56	8	4W x 28D x 22H	2.2	446	625	722	816	914	1,009	1,117	1,224	1,350	1,512	1,706	1,826	2,009	2,146	
	Mono-Color Waterline	SH	56	8	U1	4W x 28D x 22H	1.9	625	780	861	943	1,025	1,110	1,198	1,292	1,399	1,537	1,704	1,797	1,957	2,071
	Dual-Color Waterline	SH	56	8	U2	4W x 28D x 22H	1.9 above Waterline 0.9 below Waterline	625	856	980	1,099	1,225	1,351	1,487	1,623	1,785	1,994	2,243	2,314	2,560	2,741

### To Order Select Below

#### 1. Series/Type/Seat

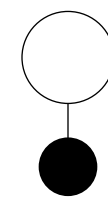

SH546

**Share  
Arm, 24H**

SH568

**Share  
Arm, 26H**

24H Arms are for Lounge Height Seats.  
26H Arms are for Task Height Seats.

The 24H arm and 26H arm are primarily intended to be used to create club chairs, loveseats, and sofas based on the modular one, two, and three seat units.

#### 2. Arm Location

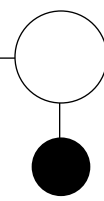

##### Arm Location

L LEFT HAND

R RIGHT HAND

M MID

Location is from the seated perspective.

#### 3. Upholstery Style

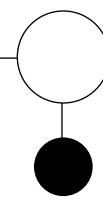

##### Upholstery Style

U1 MONO-COLOR WATERLINE

U2 DUAL-COLOR WATERLINE

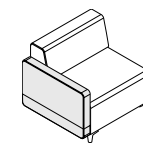

**U1**

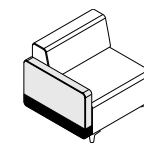

**U2**

When pricing models with more than one fabric, the higher grade fabric will determine the overall grade of the specific product.

#### 4. Upholstery

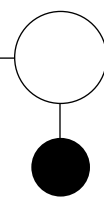

##### Upholstery

**See general information section for details on textile program and COM/COL information.**

Share will develop comfort wrinkles over time. The extent of these wrinkles is determined by the fabric specified.

# Share

## ROUND OTTOMAN

### Textile Upholstery Grades

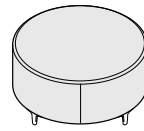
TITLE		SERIES	TYPE	SEAT	UPH	DIMENSIONS	YDG	COM	A	B	C	D	E	F	G	H	I	J	K	L	M
 <b>Round Ottoman, Lounge Height</b>	Standard Upholstery	SH	04	86		36D x 16H	3.4	2,921	2,944	3,105	3,264	3,428	3,593	3,773	3,951	4,164	4,439	4,764	4,897	5,205	5,522
	Mono-Color Waterline	SH	04	86	U1	36D x 16H	3.4	2,921	3,223	3,386	3,544	3,709	3,874	4,052	4,230	4,442	4,717	5,044	5,167	5,475	5,791
	Dual-Color Waterline	SH	04	86	U2	36D x 16H	2.6 above Waterline 1 below Waterline	2,921	3,240	3,413	3,582	3,754	3,927	4,118	4,309	4,533	4,824	5,169	5,305	5,634	5,966
<b>Round Ottoman, Task Height</b>	Standard Upholstery	SH	04	88		36D x 18H	3.6	2,921	3,038	3,212	3,379	3,553	3,727	3,916	4,107	4,328	4,622	4,967	5,110	5,439	5,772
	Mono-Color Waterline	SH	04	88	U1	36D x 18H	3.6	2,921	3,318	3,491	3,660	3,831	4,004	4,193	4,386	4,610	4,899	5,248	5,378	5,706	6,040
	Dual-Color Waterline	SH	04	88	U2	36D x 18H	2.8 above Waterline 1 below Waterline	3,698	4,035	4,217	4,394	4,578	4,760	4,962	5,163	5,398	5,705	6,070	6,189	6,536	6,889

### To Order Select Below

#### 1. Series/Type/Seat

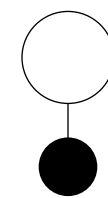

SH0486

**Share Round Ottoman, Lounge Height**

SH0488

**Share Round Ottoman, Task Height**

#### 2. Leg

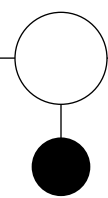

**Leg**

L1 CORNER LEG, ADJ. PLASTIC GLIDES

L2 ROUND LEG, ADJ. PLASTIC GLIDES

L3 WOOD LEG

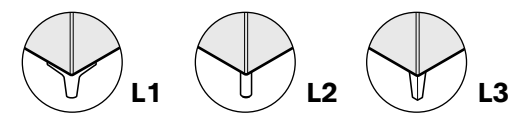

#### Mobility

The round leg glide has a larger diameter (1") than the corner leg for easier sliding on low pile carpet. Stylex is not responsible for damage to carpeting or floors.

#### 3. Leg Finish

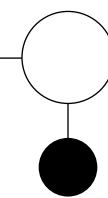

**Standard Powder Coated Metal**

BL BLUE

BM BLACK MATTE

CP CHAMPAGNE

DB DARK BRONZE

DG DARK GRAY

DP DUSTY PINK

DS DARK SAGE

LG LIGHT GRAY

LL LILAC GRAY

LP LIGHT PISTACHIO

LR LIPSTICK RED

MB MIDNIGHT BLUE

MG MEADOW GREEN

MK MILK

MS METALLIC SILVER

NK NICKEL

OC OCHRE

PY PALE YELLOW

RO RED ORANGE

RR RUSTY RED

SB SOFT BLUE

SD SAND

TC TERRACOTTA

TP TAUPE

#### 4. Upholstery Style

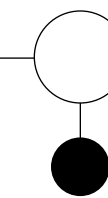

**Upholstery Style**

U1 MONO-COLOR WATERLINE

U2 DUAL-COLOR WATERLINE

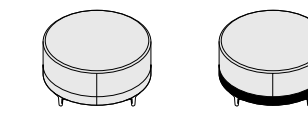

**U1**

**U2**

When pricing models with more than one fabric, the higher grade fabric will determine the overall grade of the specific product.

#### 5. Upholstery

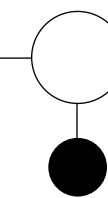

**Upholstery**

**See general information section for details on textile program and COM/COL information.**

Share will develop comfort wrinkles over time. The extent of these wrinkles is determined by the fabric specified.

# Share

ACCESSORIES: CUBE SEAT

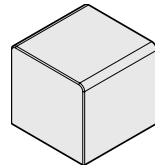
								Textile Upholstery Grades													
TITLE		SERIES	TYPE	SEAT	UPH	DIMENSIONS	YDG	COM	A	B	C	D	E	F	G	H	I	J	K	L	M
 <b>Accessories, Cube Seat, Lounge Height</b>	Standard Upholstery	SH	41	06		19W x 19D x 16H	1.4	920	1,038	1,104	1,167	1,231	1,296	1,369	1,439	1,524	1,631	1,757	1,812	1,934	2,036
	Mono-Color Waterline	SH	41	06	U1	19W x 19D x 16H	1	1,114	1,196	1,241	1,289	1,336	1,381	1,432	1,483	1,542	1,619	1,710	1,750	1,838	1,910
	Dual-Color Waterline	SH	41	06	U2	19W x 19D x 16H	1 above Waterline 0.4 below Waterline	1,114	1,229	1,295	1,361	1,426	1,489	1,560	1,631	1,715	1,822	1,949	2,005	2,128	2,230
<b>Accessories, Cube Seat, Task Height</b>	Standard Upholstery	SH	41	08		19W x 19D x 18H	1.5	920	1,048	1,117	1,185	1,256	1,324	1,400	1,477	1,566	1,681	1,819	1,875	2,006	2,116
	Mono-Color Waterline	SH	41	08	U1	19W x 19D x 18H	1.1	1,114	1,205	1,257	1,307	1,356	1,406	1,462	1,522	1,586	1,669	1,772	1,814	1,910	1,991
	Dual-Color Waterline	SH	41	08	U2	19W x 19D x 18H	1 above Waterline 0.4 below Waterline	1,114	1,239	1,308	1,375	1,447	1,515	1,592	1,667	1,754	1,873	2,009	2,005	2,128	2,230

To Order Select Below

### 1. Series/Type/Seat

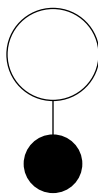

SH4106

**Share  
Accessories, Cube Seat,  
Lounge Height**

SH4108

**Share  
Accessories, Cube Seat,  
Task Height**

The light weight cube seat can be stowed along side other share pieces and easily moved as required.

### 2. Upholstery Style

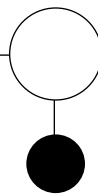

**Upholstery Style**

U1 MONO-COLOR WATERLINE

U2 DUAL-COLOR WATERLINE

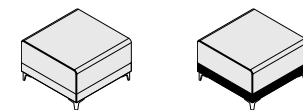

U1

U2

When pricing models with more than one fabric, the higher grade fabric will determine the overall grade of the specific product.

### 3. Upholstery

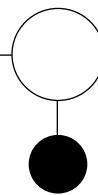

**Upholstery**

**See general information section for details on textile program and COM/COL information.**

Share will develop comfort wrinkles over time. The extent of these wrinkles is determined by the fabric specified.

# Share

ACCESSORIES: PRIVACY SCREEN

## Textile Upholstery Grades

TITLE	SERIES	TYPE	SEAT	UPH	DIMENSIONS	YDG	COM	A	B	C	D	E	F	G	H	I	J	K	L	M
<b>Accessories, Privacy Screen</b>	Standard Upholstery	SH	31	00	27W x 1.25D x 43H	1.6	769	903	976	1,050	1,123	1,196	1,278	1,361	1,455	1,577	1,724	1,787	1,927	2,044
					Overall Height: 47 Height Above Back: 18 Height Above Back on Banquette Chairs: 11															

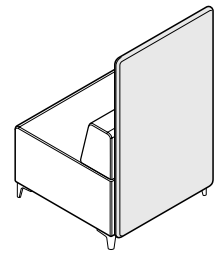

### To Order Select Below

#### 1. Series/Type/Seat/Height

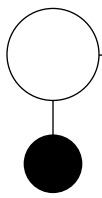

SH31006

**Share  
Accessories, Privacy Screen,  
Lounge Height**

SH31008

**Share  
Accessories, Privacy Screen,  
Task Height**

**Important Information**  
Share privacy screens are field installed on chairs. Each seat takes one screen. Screens can be removed without damage to chair upholstery. To simplify screen installation brackets are pre-installed at the factory based on floor plans submitted with an order.

Note: Privacy screens are unavailable on curved units.

#### 2. Upholstery Style

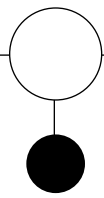

**Upholstery Style**

U1 MONO-COLOR WATERLINE

U2 DUAL-COLOR WATERLINE

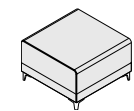

U1

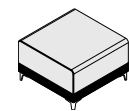

U2

When pricing models with more than one fabric, the higher grade fabric will determine the overall grade of the specific product.

#### 3. Upholstery

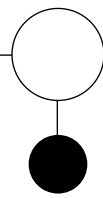

**Upholstery**

**See general information section for details on textile program and COM/COL information.**

Share will develop comfort wrinkles over time. The extent of these wrinkles is determined by the fabric specified.