

stylex

Still Screens

PRICE LIST

Effective November 01, 2024

Updated November 06, 2024

General Information

STYLEX PRICE LIST

GENERAL INFORMATION

Terms

Net 30 days from date of invoice,
F. O. B . Delanco, New Jersey.

Damaged Shipments

All Stylex products are carefully inspected before they are packed in sturdy cartons designed to satisfy shipping requirements. Stylex is not responsible for damage in shipment. The transportation company assumes responsibility for delivering products to you in good condition when the bill of lading is signed. You protect yourself by refusing shipments showing damage or shortage until transportation company has noted on the delivery sheet the extent of damage or shortage. Concealed damage should be reported to the carrier as soon as discovered, but no later than 5 days after receiving shipment.

Return/Restocking Policy

Return shipments will not be accepted unless specifically authorized by Stylex in writing. The Return Authorization number should be clearly marked on the carton. The customer returning Stylex products is responsible for return shipping costs. Merchandise must be returned unused. Returned merchandise is subject to a 35% restocking fee.

Special Products

Modifications to standard products will be considered for large runs. Contact factory for price quotations.

Design Changes

In keeping with modern manufacturing advances, Stylex reserves the right to incorporate minor modifications and design changes in products without notice.

Cancellation/Change Order Policy

Regarding requests for order cancellation and/or order modification, please be advised that no charges will be applied before production, unless inventory has been specifically requisitioned to fulfill your order. Once orders proceed to the production phase, they cannot be altered or canceled under any circumstances. All requests for order cancellations or order changes must be submitted in writing and will only be considered valid upon approval by Stylex.

WARRANTY

Except as provided below, Stylex warrants exclusively to the original Purchaser of our product that all parts, under normal use and service, will be free from defects in workmanship and material for a period of ten (10) years from the date of purchase. "Normal use and service" means that the product will be used in a typical office environment for 40-45 hours per week.

This warranty is subject to the following limitations, exclusions and provisions:

Limitations involving materials and components:

Wood components of plywood stacking chairs
(such as Brooks and Welcome)
5 years

Upholstery

(including mesh used for Click, F4, Insight, and Zephyr Mesh)
3 years

SAVA Mesh

10 years

Pneumatic Cylinders

3 years

COM Upholstery

No warranty
Stylex makes every effort to ensure that the COM Upholstery it approves is suitable for the intended use. Nevertheless, we will not warrant, and assume no responsibility for, the durability or tailoring quality of any COM or COL . If you have any concerns about the ultimate appearance of any covering, please order an upholstered sample.

Painted Stack Chair Frames

No Warranty
We will not warrant the finish of painted stack chair frames against damage from stacking. Please order chrome frames for chairs that will be stacked.

Felt Glides

No warranty
Due to the different surfaces on which felt glides may be used, we cannot warrant their durability over time.

If this product fails during normal use and service within the applicable warranty period (other than through normal wear and tear), please submit a warranty claim at stylexdesign.com/warranty-claim/. Quantity, model details, description of issue, and Stylex certified labels are required for submission. PLEASE DO NOT RETURN PARTS OR THE PRODUCT TO STYLEX UNLESS INSTRUCTED TO DO SO BY STYLEX. Stylex will, at its discretion, either repair or replace the defective product or part at no cost. Labor requests must receive approval and will be authorized on a case-by-case basis. We will only reimburse for labor costs directly incurred, excluding any travel-related expenses. Purchaser may be required (at the option of Stylex) to return to Stylex at Purchaser's expense any defective part with all freight or shipping charges prepaid. The foregoing warranty shall be void if the product has been altered or repaired (other than by Stylex). The warranty does not cover damage to the product caused by accident, neglect, misuse, abuse, modification to the product by anyone other than Stylex or damage caused by use of the product for a purpose other than that for which it was designed. This warranty extends only to the original Purchaser of the product.

No Other Warranties

This warranty is in lieu of all other warranties, expressed or implied, including, but not limited to, implied warranties of merchantability and fitness for a particular purpose. The rights and remedies provided herein are the exclusive rights and remedies of the original purchaser of the product.

No Liability For Damages

In no event shall Stylex or its suppliers be responsible or liable for any special, indirect, consequential, or incidental damages. In no event shall the liability of Stylex exceed the actual purchase price paid to Stylex for the product.

Out of Warranty Products

For all products no longer covered by our warranty, please refer to our Design for Durability and Upgradability Policy. Contact your Account Manager if you would like to purchase any replaceable components to further extend the life of any Stylex seating product. This warranty applies to all Stylex products purchased on April 13, 2018, and thereafter.

PRODUCT TAKE BACK PROGRAM

In order to be good stewards of our products, Stylex offers a pathway towards a Product Take Back Program as a more viable solution to the end of our products' originally intended life.

Stylex supports the sustainable programs of ANEW and offers their added value to our clients through a comprehensive take-back solution for surplus office furniture and materials of any kind, in any condition. ANEW is a 501(c)(3) non-profit organization that exists to provide companies with smart, cost effective alternatives for their surplus furniture and other items with the priority of matching it to non- profits, public agencies and the underserved, within the local community of the project site. Corporate Social Responsibility is raised while the impact on the environment is lowered by diverting products and materials otherwise destined for landfill.

Stylex is proud to offer ANEW to customers dedicated to strengthening their community network by repurposing their furniture, fixtures and architectural materials to those in need. In 2014, Stylex committed to making this relationship a part of our strategic sales strategy. Visit www.anewfound.org to find out more.

To initiate a Product Take Back strategy through ANEW, contact Stylex Account Management at 800-257-5742.

For other end of life recovery options, please see our Product Disassembly Instructions and End of Life Recovery Options documents available on our website in the resources section of each product in our line.

FREIGHT PROGRAM

Freight charges will be calculated as a percentage of the net product price and added to the invoice at the time of shipment. The continental United States has been divided into three zones. Please use the map below to determine freight charges for the product's destination. Minimum freight charge is \$250. Please let us know if you will be shipping to a residential address or require inside delivery as this requires an additional fee. Also please note we need to be made aware if a liftgate is required prior to delivery. If any requests are made at the time of delivery, applicable charges will apply.



ZONE 1 - 4%

Connecticut
Delaware
New York
New Jersey
Maryland
Massachusetts
North Carolina
Ohio
Pennsylvania
Rhode Island
Virginia
Washington D.C.
West Virginia

ZONE 2 - 5%

Alabama
Arkansas
Canada, Ontario
Canada, Quebec
Florida
Georgia
Iowa
Illinois
Indiana
Kansas
Kentucky
Louisiana
Nebraska
New Hampshire
Oklahoma
Maine
Michigan
Minnesota
Missouri
Mississippi
South Carolina
Tennessee
Texas
Vermont
Wisconsin

ZONE 3 - 6%

Arizona
California
Colorado
Idaho
Montana
Nevada
New Mexico
North Dakota
Oregon
South Dakota
Utah
Washington
Wyoming

Quote Per Project

Alaska
Hawaii
Canada
(outside Ontario & Quebec)
Mexico

General Information

STYLEX PRICE LIST

TEXTILE PARTNERS & APPROVALS

Textile Partners

To customize your furniture performance needs and design vision, Stylex offers a wide selection of in-graded leathers and textiles from Grades A through Y. We've partnered with leading manufacturers on the options, focusing on color, price, durability, and construction. To view our partners and explore our digital carded program with broadly approved textiles, visit [this page](#). We stand by these textiles: They're tried and tested, and will effortlessly fit into any design aesthetic.

Textile Approvals

All textiles must be approved for the product you are specifying. For the related approved textile lists, visit [this page](#).

CAL 117 AND 133 COMPLIANCE

CAL 117-2013

CAL 117-2013 compliance is a requirement for all textiles applied on our seating products. All Stylex seating products meet this standard.

CAL 133

Most Stylex seating can be ordered to meet the requirements of CAL 133. When ordering, simply specify "CAL 133 compliance required". The upcharge for this option is \$54 list per yard. Please refer to the COM yardage of each model to determine the number of yards required. We do frequently require full-scale burn tests in order to certify CAL 133 before an order will be accepted. Such burn tests may increase normal lead times and do carry additional charges. Please contact your Stylex account manager for details.

CUSTOMER'S OWN MATERIAL/LEATHER

Customer's own material (COM) and customer's own leather (COL) will generally be upholstered at the price designated in each product's price list. Please be advised, however, that we specifically reserve the right to charge a higher price when we determine that special circumstances, such as unusual repeats or challenging materials, present themselves. All orders for custom coverings must be approved by Stylex before they will be accepted for production. To submit proposed textile for approval, please use the COM form [here](#).

Special Note:

We assume no responsibility for the durability or tailoring quality of any COM or COL. Directional covers in particular may not meet your satisfaction due to the design of certain products. Please be advised that COM and COL orders are not subject to return. If you have doubts about the ultimate appearance of certain coverings, please order a sample done with that specific COM or COL. In addition, while we inspect fabrics for mill imperfections, some are difficult to recognize. We cannot be responsible for defects, color inaccuracies, dye lot variations, or other flaws.

Under no circumstances will we be responsible for COM shortages, flaws, or other such problems. Finally, it is not our responsibility to police the receipt of COM's in order to meet delivery deadlines, and we assume our customers are aware of any undue delay in the shipment of their COM fabrics.

COM fabric and COL leather should be sent prepaid to: Stylex

**Attn: COM/COL - [Your Stylex PO #]
740 Coopertown Road
Delanco, NJ 08075**

All COM/COL sent to Stylex must be accompanied with a packing list which indicates the dealers' name, Stylex corresponding PO number, sales order number, COM/COL supplier name, textile pattern, colorway and shipped quantity. Stylex requires COM to be sent in as continuous yardage in the same dielot.

Yardage requirements shown in the price list are based on non-directional goods of 54" width. Fabrics less than 54" wide or those requiring matching (stripes, prints, or large patterned designs) call for additional yardage. We will be happy to supply yardage requirements for large quantities where economies may be realized.

Add the following yardage for stripes, plaids, or patterns with repeats:

Fabric Width	Plain Fabric	2-14" Repeat	15-24" Repeat	25-27" Repeat	28-36" Repeat
54"	0%	10%	15%	20%	25%
50"	10%	20%	25%	30%	35%
48"	15%	25%	30%	35%	40%
45"	40%	50%	55%	60%	65%
36"	50%	60%	65%	70%	75%

COM/COL FORM

To avoid delay in processing COM orders we request that you submit a sample of your COM textile stapled to this form which can be downloaded [here](#). If a textile has a stripe or design, the size of the repeat should be indicated. Please indicate the textile supplier's name, textile number, and color. Also indicate the Stylex product on which the textile will be used. If a certain direction of application is required, please ensure that information is communicated directly to your Stylex account manager.

The fabric supplier must indicate on his shipping labels the dealer name and purchase order number as well as the Stylex model number.

Please Note:

No order may be entered into production or have a shipping date assigned until all related COM is received at the factory.



CENTER OF STRIPE OR DESIGN

TOP OF CHAIR	TOP OF CHAIR
--------------	--------------

1. Size of Repeat

2. Textile Supplier

3. Textile Number

4. Color

5. Stylex Product

Still Screens

Contents

<hr/>		<hr/>	
COLORS, MATERIALS, AND FINISHES	5	HOW TO ORDER	15
<hr/>		<hr/>	
STATEMENT OF LINE	6	UPHOLSTERED SCREENS	17
<hr/>		<hr/>	
DIMENSIONS	7	WOOD SCREENS	27
<hr/>		<hr/>	
LAYOUT RULES	8	BASEPLATES AND ACCESSORIES	31
<hr/>		<hr/>	
POWER	11		
<hr/>			

CLICK THE TITLES ABOVE TO NAVIGATE THROUGH THE DOCUMENT
PRODUCT HEADERS ON SUBSEQUENT PAGES LINK BACK TO THIS PAGE

Still Screens

COLORS, MATERIALS, AND FINISHES

POWDER COATED METAL

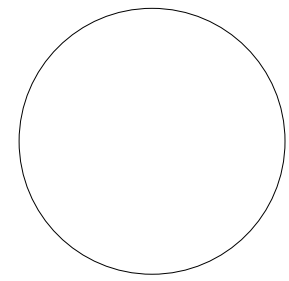

MILK
(MK)

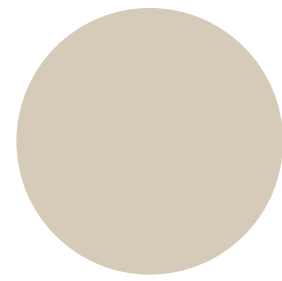

SAND
(SD)

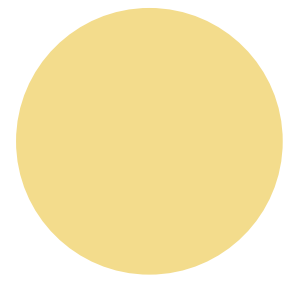

PALE YELLOW
(PY)

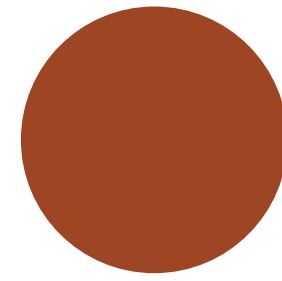

TERRACOTTA
(TC)

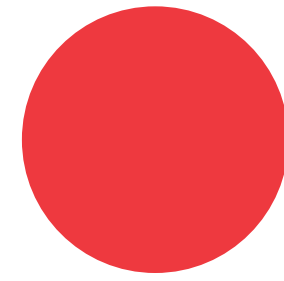

LIPSTICK RED
(LR)

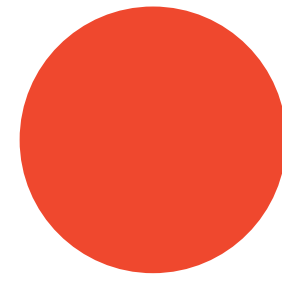

RED ORANGE
(RO)

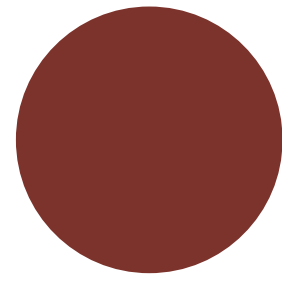

RUSTY RED
(RR)

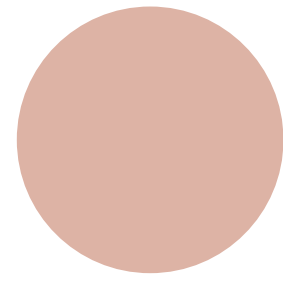

DUSTY PINK
(DP)



LIGHT PISTACHIO
(LP)

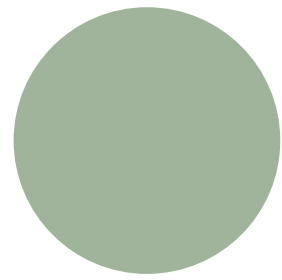

MEADOW GREEN
(MG)

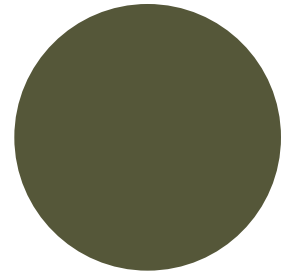

DARK SAGE
(DS)

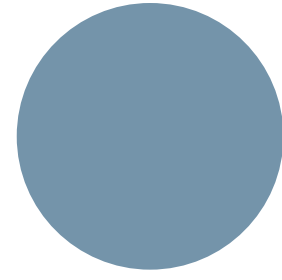

SOFT BLUE
(SB)

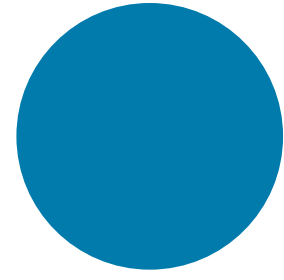

BLUE
(BL)

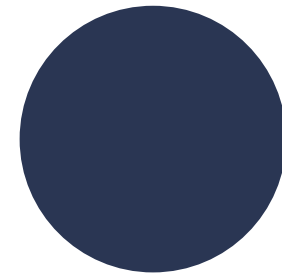

MIDNIGHT BLUE
(MB)



LILAC GRAY
(LL)

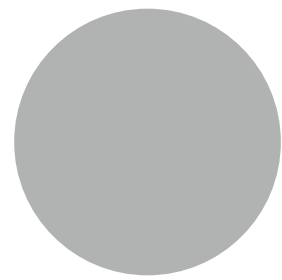

LIGHT GRAY
(LG)



CHAMPAGNE
(CP)

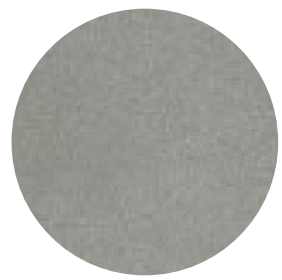

METALLIC SILVER
(MS)



NICKEL
(NK)

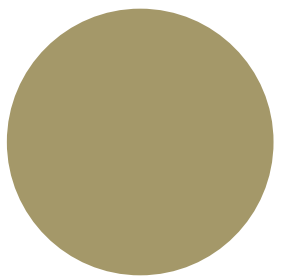

OCHRE
(OC)

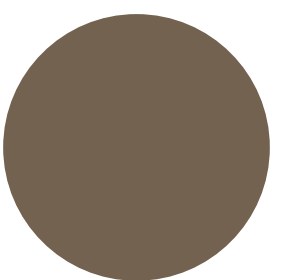

TAUPE
(TP)



DARK BRONZE
(DB)

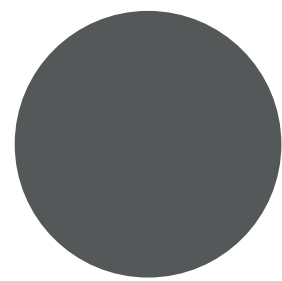

DARK GRAY
(DG)

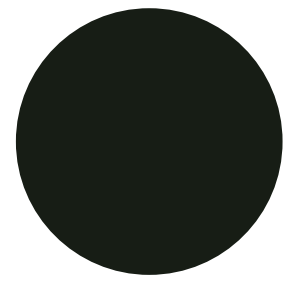

BLACK MATTE
(BM)

SOLID WOOD



NATURAL MAPLE
(SW83)



OAK
(SW81)



WALNUT
(SW85)





OPAQUE BLACK
(SW87)

Still Screens

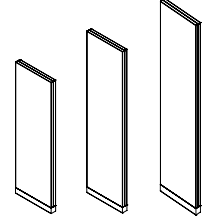
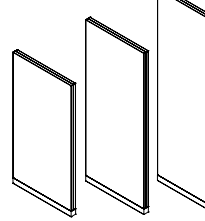
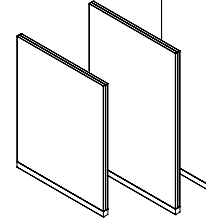
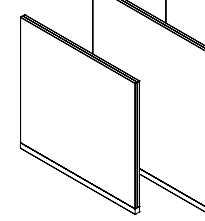
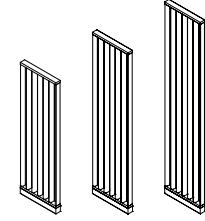
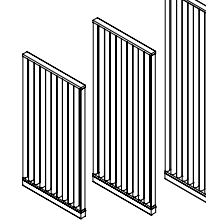
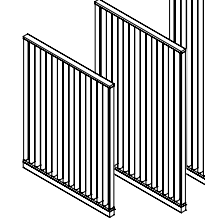
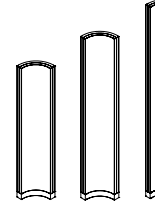
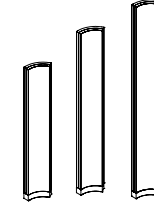
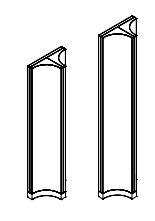
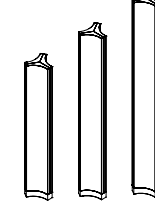
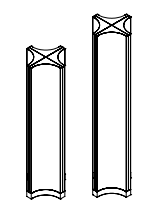
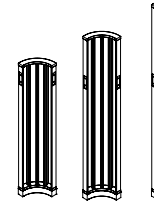
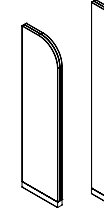
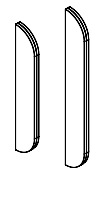
SPECIFICATION GUIDE: STATEMENT OF LINE

OVERVIEW	UPHOLSTERED					WOOD		
Screens 48H, 59H, 70H	15W 	24W 	36W 	48W 		15W 	24W 	36W 
Corners 48H, 59H, 70H	90° Corner 	120° Corner 	3-Way T 	3-Way Y 	4-Way 	90° Corner 		
Transitions 59H, 70H	15W 							
End Caps 48H, 59H, 70H	8W 							

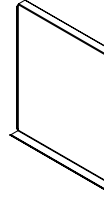
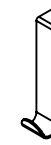
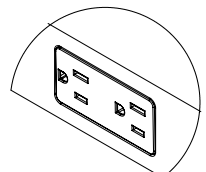
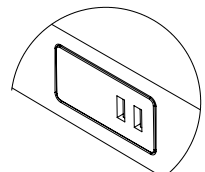
Bases	Small	Large	Large Mid	
				
Accessories and Power	White Board	Hook	Duplex Receptacle	USB
				

PRODUCT INFORMATION

Design Fig40

Screens

Upholstered screens are constructed with an internal wood frame. Acoustic insulation is adhered to absorb environmental noise and provide a soft, tackable surface. They are fully upholstered with no visible hardware. Wood screens are constructed of solid oak, maple or walnut and finished in a satin clear water-based finish.

Bases

Bases are constructed of steel plates and equipped with felt glides. Small and Large bases align with the edge of a screen. The Large Mid Base is centered on the joint between two screens. Screens are assembled with adjustable height plastic glides at each end. Glides on straight screens may be replaced with bases ([pg 6](#)) as needed for stability. See [page 8](#) for layout rules. Powder coated baseboards snap into place after screens are ganged together in an assembly. Baseboards and bases may be powder coated in one of our 26 colors.

Ganging

Screens are equipped with lower connectors in the baseboard and recessed upper connectors to allow for concealed ganging. As a default, 48"H screens include a single upper connector and 59"H and 70"H screens include two upper connectors per side. Upper connectors may be excluded from one or both sides of a screen for a smooth edge when exposed in an assembly.

Power

Power receptacles are offered in 24"W and larger screens. Two different power receptacles are available - dual USB power ports or dual grounded 3-prong electrical outlets. Both options are available in 3 colors. Refer to Power Information on [pages 11-14](#).

Accessories

Coat hooks are constructed of bent steel and may be powder coated in one of our 26 colors. These can be hung anywhere on an upholstered screen. Weight limit 10 lb. Whiteboards are constructed of bent steel and powder coated in a white dry erase finish. These can be hung anywhere on an upholstered screen.

Testing



Manufactured to comply with:
ANSI/BIFMA X5.6 Panel Systems - Tests

Certifications

Greenguard Gold
LEVEL® 2

Still Screens

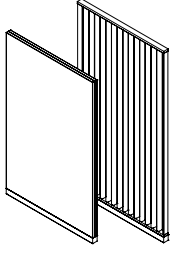
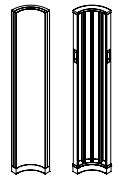
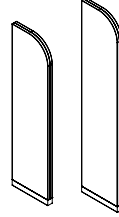
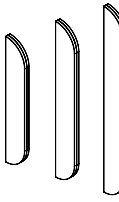
SPECIFICATION GUIDE: DIMENSIONS

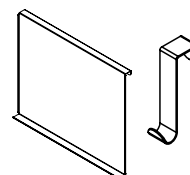
DIMENSIONS		UPHOLSTERED				WOOD				
Screens A. Screen Height B. Screen Width C. Screen Thickness		15W A. 48, 59, or 70 B. 15 C. 1.875	24W A. 48, 59, or 70 B. 24.5 C. 1.875	36W A. 48, 59, or 70 B. 36.375 C. 1.875	48W A. 48, 59, or 70 B. 48 C. 1.875		15W A. 48, 59, or 70 B. 15 C. 1.875	24W A. 48, 59, or 70 B. 24.5 C. 1.875	36W A. 48, 59, or 70 B. 36.375 C. 1.875	
Corners A. Corner Height B. Corner Length C. Corner Width D. Corner Thickness		90° Corner A. 48, 59, or 70 B. 8 C. 8 D. 1.875	120° Corner A. 48, 59, or 70 B. 7.3 C. 5.2 D. 1.875	3-Way T A. 48, 59, or 70 B. 14.125 C. 8 D. 1.875	3-Way Y A. 48, 59, or 70 B. 8.5 C. 8.5 D. 1.875	4-Way A. 48, 59, or 70 B. 14 C. 14 D. 1.875	90° Corner A. 48, 59, or 70 B. 8 C. 8 D. 1.875			
Transitions A. Transition Height B. Transition Width C. Transition Thickness		15W A. 59, or 70 B. 15 C. 1.875								
End Caps A. End Cap Height B. End Cap Width C. End Cap Thickness		8W A. 48, 59, or 70 B. 8 C. 1.875								
Bases A. Base Length B. Base Width C. Base Thickness		Small A. 14 B. 6 C. 0.18	Large A. 18 B. 8.5 C. 0.25	Large Mid A. 18 B. 9.25 C. 0.25						
Accessories A. Accessory Height B. Accessory Width C. Accessory Thickness		White Board A. 29.75 B. 36.375 C. 2.5	Hook A. 6.6 B. 1.5 C. 1.5							

Still Screens

SPECIFICATION GUIDE: LAYOUT RULES, LINEAR ASSEMBLIES

LINEAR ASSEMBLIES

General Guidelines

Large baseplates must be installed at each end of a freestanding or linear assembly.

Additional large baseplates are needed along the length of the assembly if it exceeds the maximum length.

All dimensions given are the stated widths of screens, not the measured widths. For layout rule purposes, screen widths are 15", 24", 36", and 48", Transition screens are 15", and Endcaps are 8".

Endcaps must match adjacent screen height.

Baseplate Layout - Large

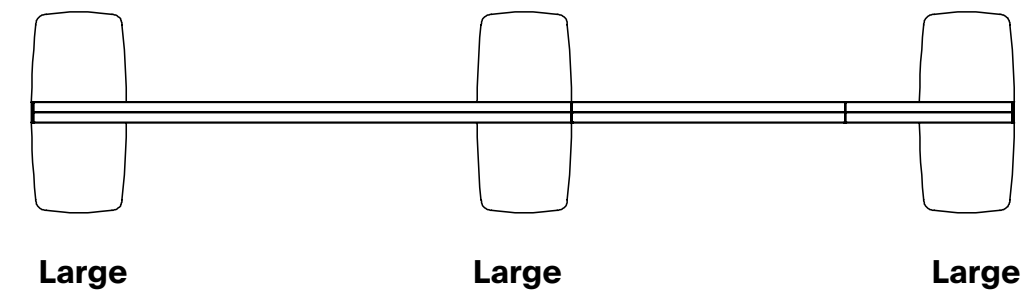

Baseplate Layout - Large Mid

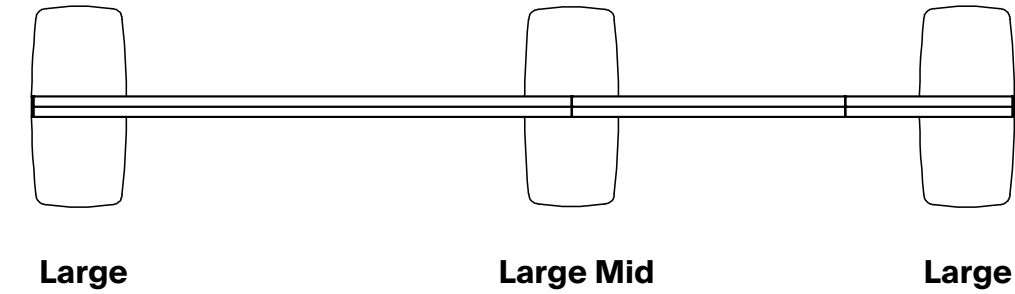

Baseplate Layout - Small

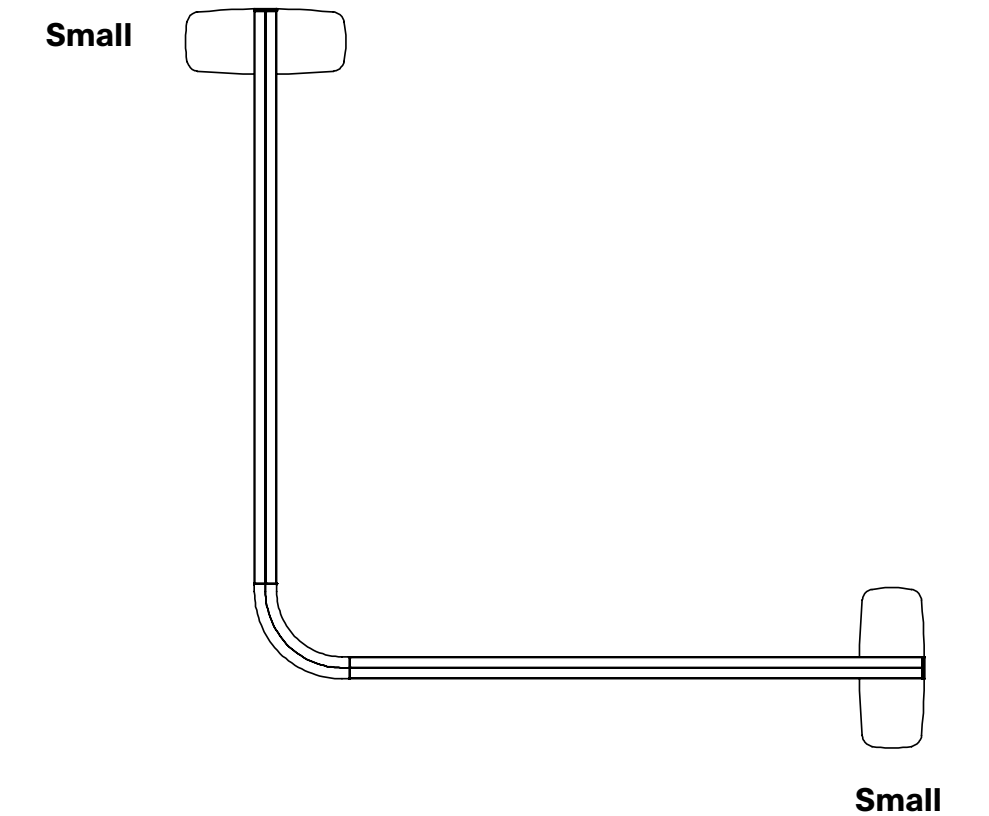

Freestanding Screens

These screens may be used on their own, with Large baseplates:

- Upholstered 48H x 36W**
- Upholstered 48H x 48W**
- Upholstered 59H x 36W**
- Upholstered 59H x 48W**
- Wood 48H x 36W**
- Wood 59H x 36W**

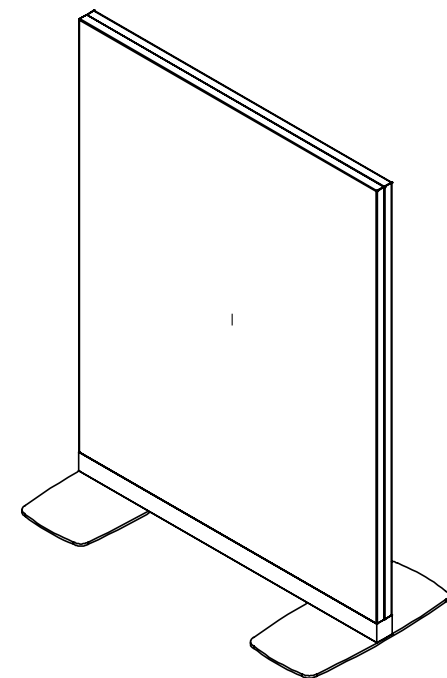

Minimum Length of Linear Assembly

Screen Type/Height	Minimum Length
Upholstered & Wood 48H	36"
Upholstered & Wood 59H	36"
Upholstered & Wood 70H	60"
Upholstered 70H	51"

*70H wood screens must be combined with upholstered screens for linear assemblies.

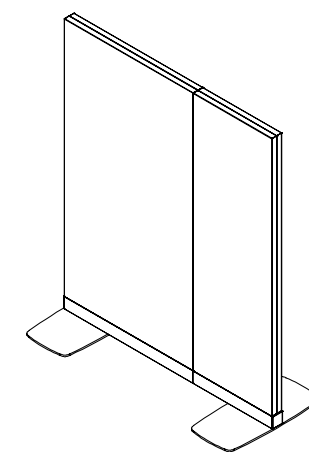
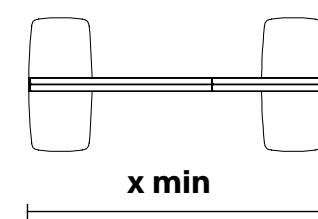

Maximum Length Between Baseplates

Screen Type/Height	Maximum Length
Upholstered 48H	72"
Upholstered 59H	72"
Upholstered 70H	63"
Wood 48H	60"
Wood 59H	51"
Wood 70H	51"

The maximum overall length for a linear assembly is 192". If a section between baseplates consists of upholstered and wood screens, use the maximum length for wood screens. If multiple height screens are connected between baseplates, use the maximum length for the tallest screen.

*70H Wood screens cannot be used alone in linear assemblies. When combined with 70H upholstered screens, no more than half of the total length may be Wood screens.

Sample Layout Large Baseplate:

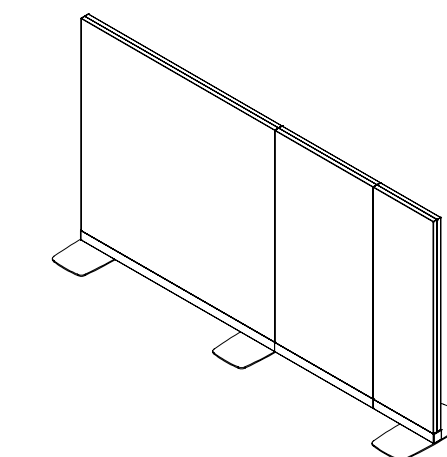
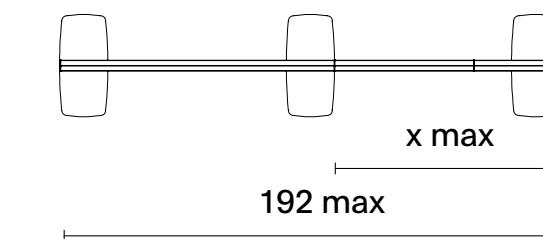

Sample Layout Large Mid Baseplate:

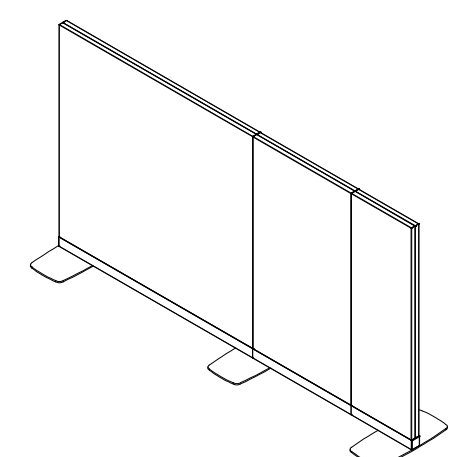
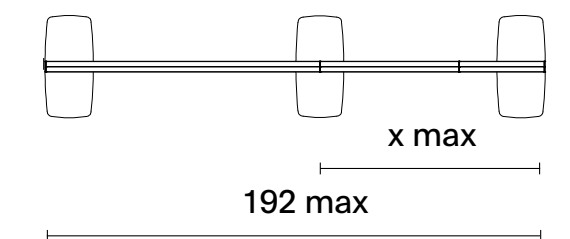

Still Screens

SPECIFICATION GUIDE: LAYOUT RULES, CORNER ASSEMBLIES

CORNER ASSEMBLIES

General Guidelines

Small baseplates may be used instead of large baseplates when a corner is included in an assembly.

Baseplates are required at the end of an assembly when the distance to a corner from that end is 30" or greater.

Endcaps and corners must match adjacent screen height. All connections on a corner must be used.

All dimensions given are the stated widths of screens, not the measured widths. For layout rule purposes, screen widths are 15", 24", 36", and 48", Transition screens are 15", and Endcaps are 8".

Endcap panels should not be included to meet minimum length requirements in corner panel layouts.

Maximum Length Between Baseplates

The length of screens between baseplates and/or to a corner should not exceed 108".

If a length supported by one corner exceeds 192", large baseplates are required on that segment.

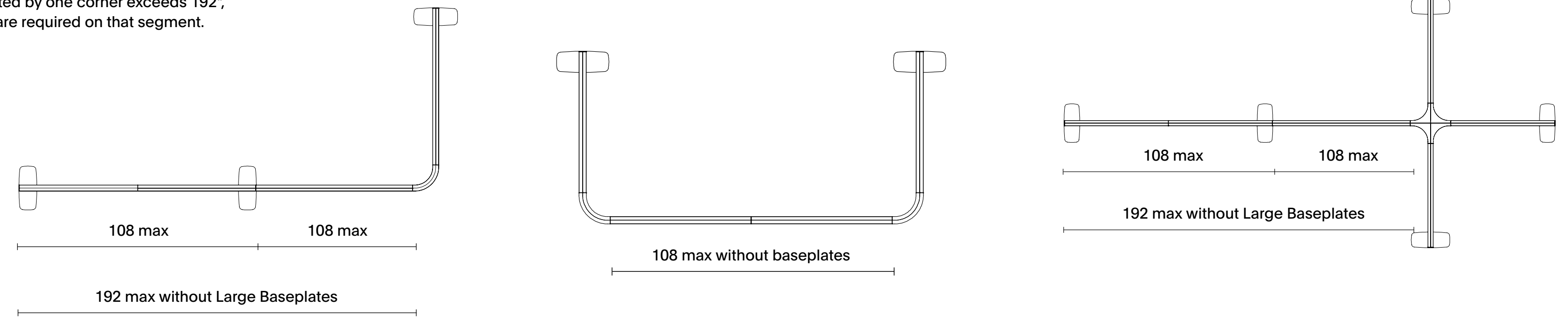

T-Shaped Assemblies

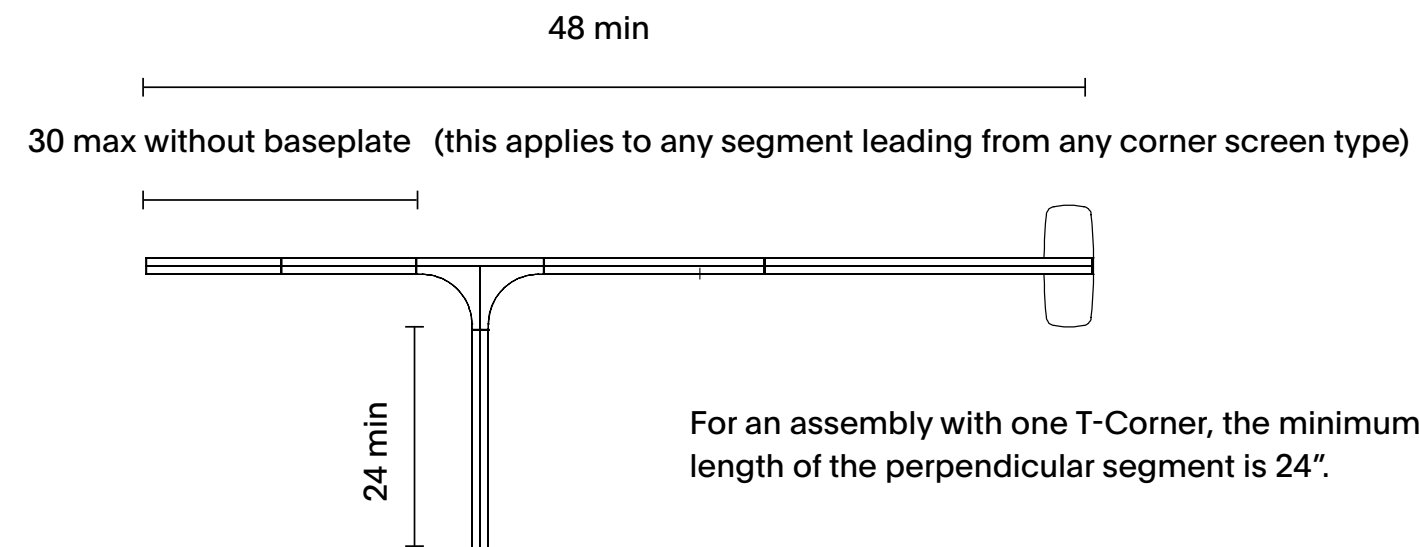

L-Shaped Assemblies

Applications including a 90° or 120° corner

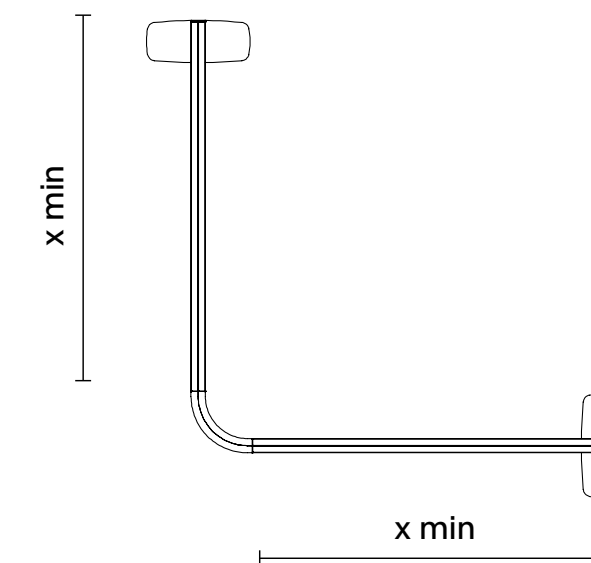

Screen Height	Minimum Length
Upholstered & Wood 48"H	30"
Upholstered & Wood 59"H	30"
Upholstered & Wood 70"H	36"

Minimum lengths are based on the tallest screen in the assembly.

One side of an L-shaped layout may be shorter than the minimum length but Large Bases must be used and it must adhere to the guidelines of a linear assembly.

Still Screens

SPECIFICATION GUIDE: LAYOUT RULES, SCREEN HEIGHT AND CONNECTORS

SCREEN HEIGHT AND CONNECTORS

General Guidelines

Corners and endcaps only connect to screens of the same height.

Connector Right (CR) or Connector Left (CL) are specified to eliminate all connectors on a side for a smooth, finished edge.

Low Connector option (LR, LL, LB) is specified on a 59H or 70H screen when connecting to a different height screen.

Connector locations are determined from Side A of a screen.

Sample Connector Selections

See [How to Order](#) for connector selection ordering steps.

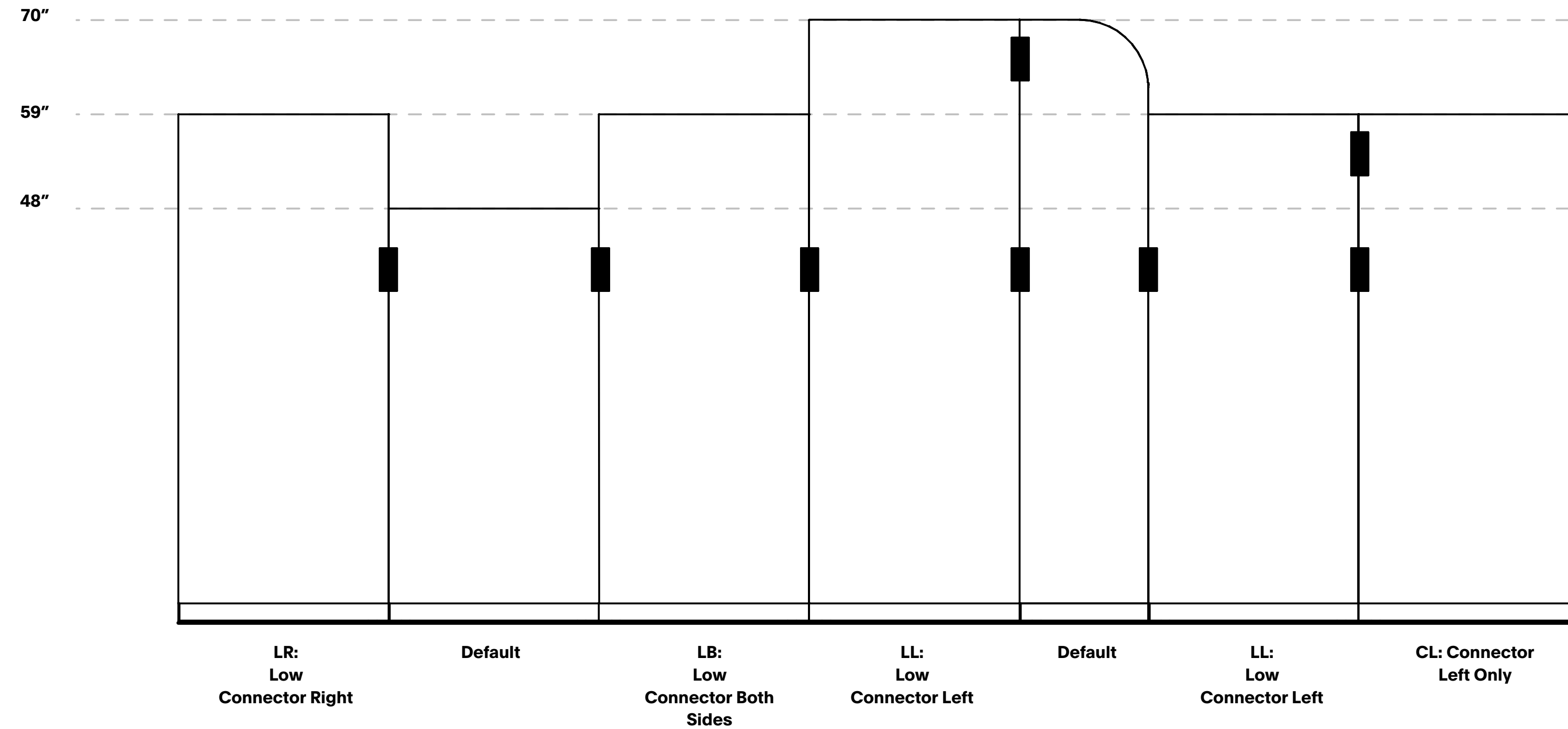

Still Screens

SPECIFICATION GUIDE: POWER

POWER SPECIFICATION

Please use pages 11-14 as a power specification guide. A full specification requires CET. If you do not use CET, you may create a quick quote using the method below and request a full specification and quote through your Stylex Rep or Account Manager.

A. Receptacle Options

Receptacles are offered as both Duplex (3-pronged outlets) or USB power ports. Three color options are available: black, gray, and white. Select these options when configuring a specific screen to include a receptacle in the layout.

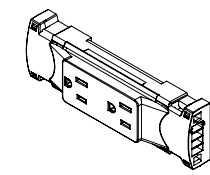

Duplex

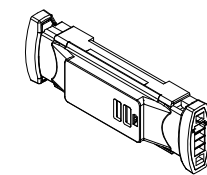

USB



Color Options

B. Infeed Options

Power is supplied to the Still system with one of multiple infeed options. A hardwired infeed is installed by an electrician and connects the system directly to the building's power supply. A corded infeed is also available with a three-pronged plug for connection to a 20amp socket. Multiple infeeds may be used if additional capacity is needed. Refer to your installer and local code requirements to specify the appropriate option.

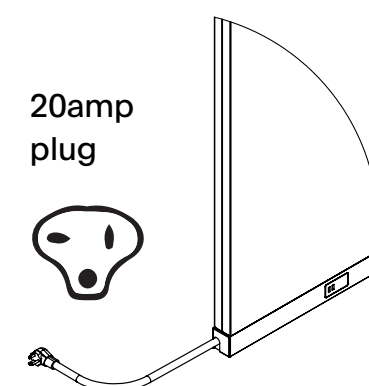

End-Infeed : Corded
UL Recognized

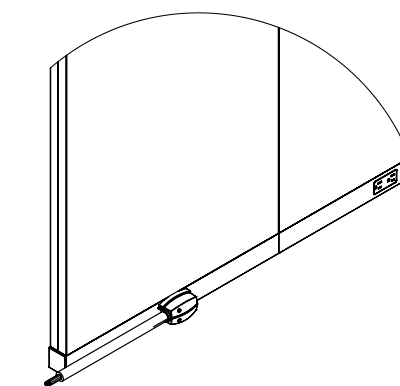

Side-Infeed : Hardwired
UL Listed

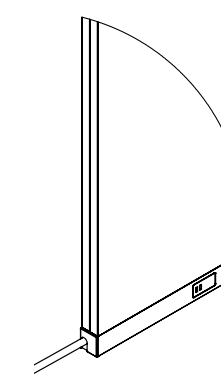

End-Infeed : Hardwired
UL Listed

*not available with liquid-tight conduit

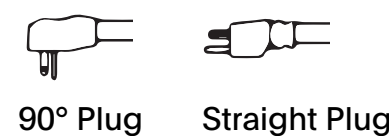

90° Plug Straight Plug

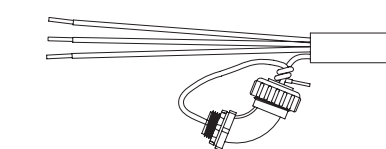
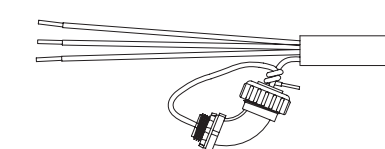

C. Internal Jumper Options

Jumpers are used to connect receptacles within the Still system. Stylex will determine jumper quantities and lengths based on layout and infeed location. Jumper material selection is based on building and local requirements. Please refer to your installer and local code requirements to specify the correct option for your needs.

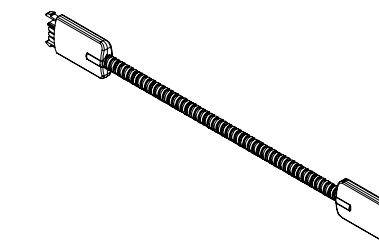

Metal Conduit
(Standard)

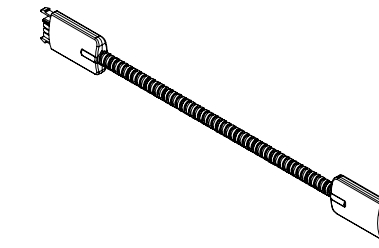

Metal Jacketed Liquid-Tight

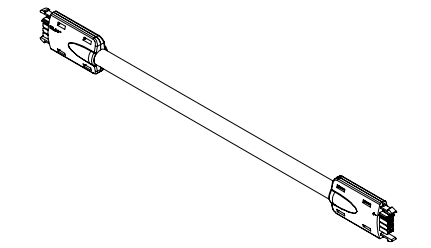

Nonmetallic Liquid-Tight

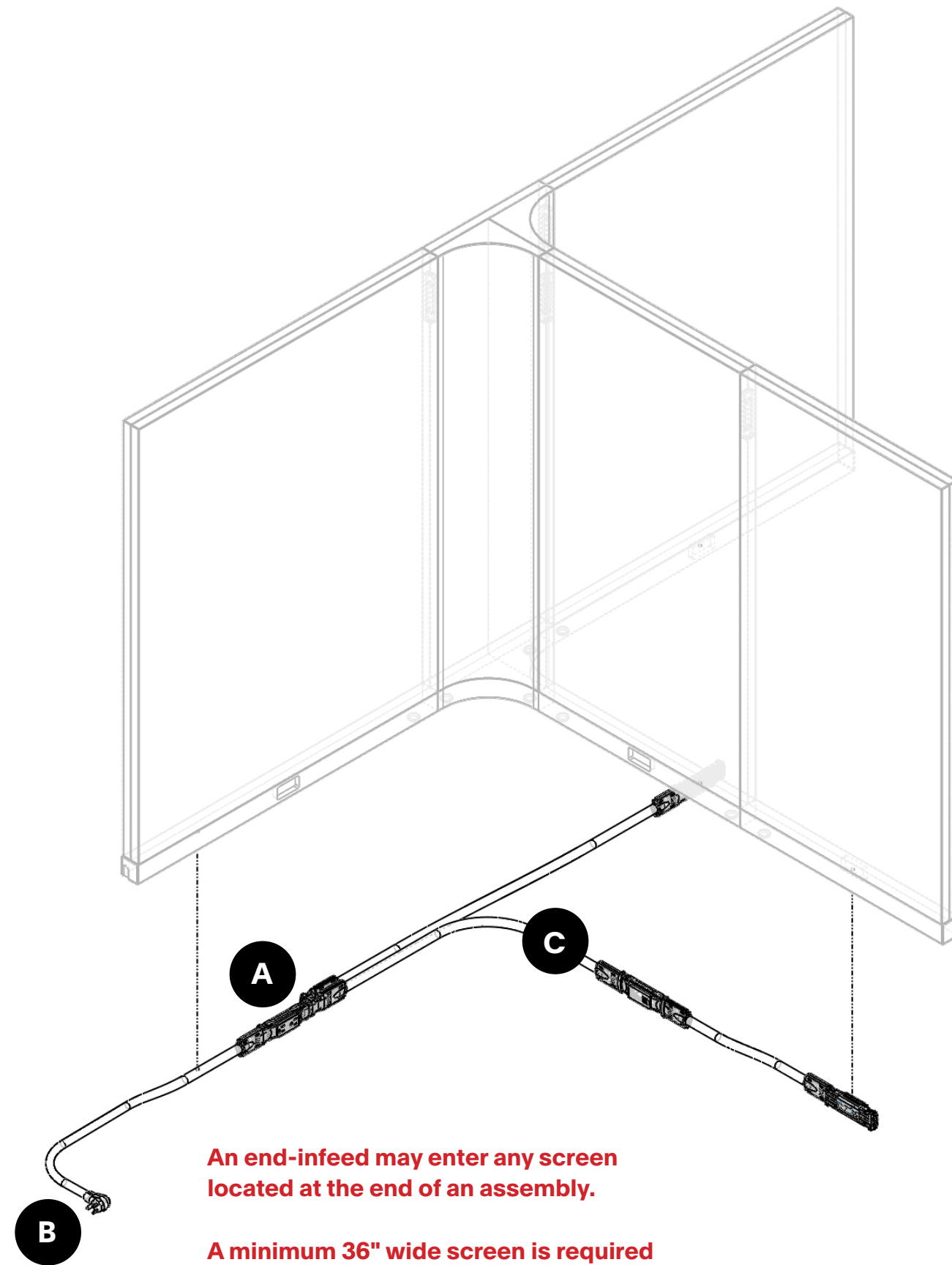

An end-infeed may enter any screen located at the end of an assembly.

A minimum 36" wide screen is required when a corded infeed and receptacle are specified in the same screen.

A hardwired infeed may connect to a receptable in any sized screen.

Still Screens

POWER GUIDE: INFEEDS, RECEPTACLES, JUMPERS AND CONNECTORS

POWER SPECIFICATION

Please use pages 11-14 as a power specification guide. A full specification requires CET. If you do not use CET, you may create a quick quote using the method below and request a full specification and quote through your Stylex Rep or Account Manager.

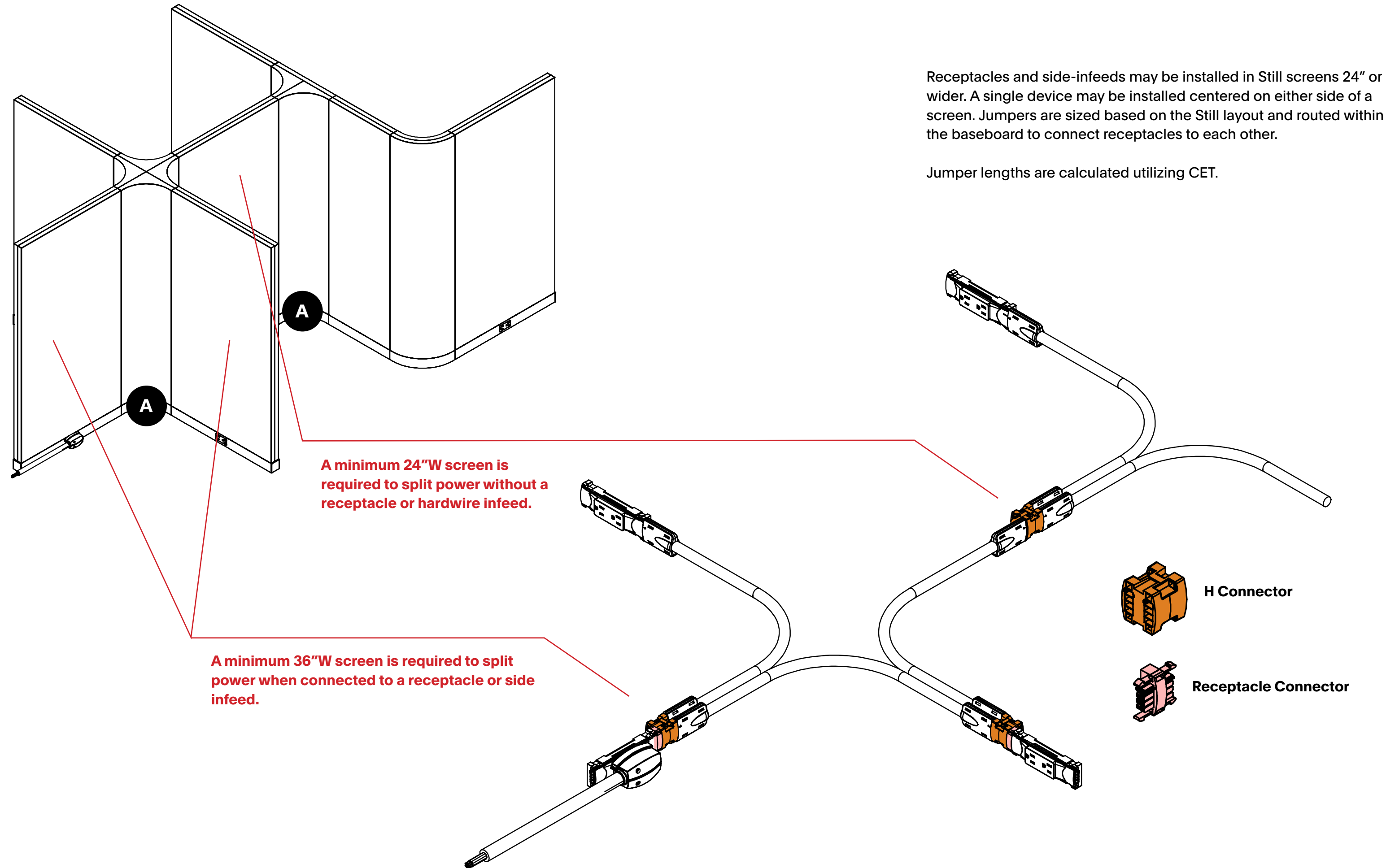

Receptacles and side-infeeds may be installed in Still screens 24" or wider. A single device may be installed centered on either side of a screen. Jumpers are sized based on the Still layout and routed within the baseboard to connect receptacles to each other.



Jumper lengths are calculated utilizing CET.

A. Splitting Power

A power system may split in two or three directions to distribute power at corners. An H-Connector must be used in a straight screen to split power, joining two jumpers together. A Receptacle Connector is used to connect a receptacle or Side-infeed to an H-Connector. A receptacle or baseplate cannot be located between a split and a corner.

Still Screens

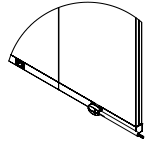
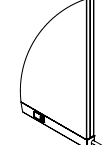
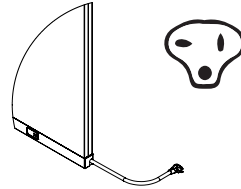
POWER

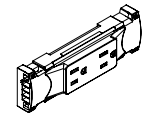
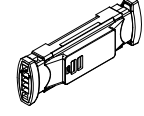
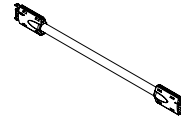
COMPONENT	MODEL OPTIONS	MODEL CODE	(XXX)=LENGTH (IN)	PRICE	DESCRIPTION AND SPECIFICATION GUIDELINES	
Infeed - Side/Hardwired		PSB4IHS	072	291	This type of infeed uses 0.5" liquid tight conduit, entering the center of the baseboard on the selected screen. 72" is left exposed, and may be cut to length during installation. Hardwired electrical systems may be wired to 1 or 2 building circuits allowing for a maximum of 26 receptacles. Hardwired Infeed is UL Listed as a Manufactured Wiring System (UL 183)	
Infeed - End/Hardwired		PSB4IHE	(XXX)	301	This type of infeed uses metal conduit wrapped in mesh sleeving and enters the end of the screen system connecting to the first receptacle. Hardwired electrical systems may be wired to 1 or 2 building circuits allowing for a maximum of 26 receptacles. Hardwired Infeed is UL Listed as a Manufactured Wiring System (UL 183). *CET is used to configure the total internal and external (24-72") length with a max total length of 120".	
Infeed - End/Corded		90° Plug 	PSB4ICN	(XXX)*	335	This type of infeed uses metal conduit within the screen system, and enters the end of the screen system with a 17" long corded 20amp plug. It is not available with liquid-tight conduit. Corded systems may only be connected to 1 circuit allowing for a maximum of 13 receptacles. Corded Infeed is UL Recognized as an Office Furnishing Accessory (UL 1286) *CET is used to configure the total internal and external length with a max total length of 144".
		Straight Plug 	PSB4ICS	(XXX)*	216	
Receptacle - Duplex		Duplex Black	PSB4DB1 / PSB4DB2		267	Each Duplex receptacle has two 3-prong outlets. There is a 13 Duplex Receptacle limit on 1 circuit systems for each infeed. The limit is increased to 26 on 2 circuit systems. The last digit in the model code indicates the circuit number.
		Duplex Gray	PSB4DG1 / PSB4DG2		277	
		Duplex White	PSB4DW1 / PSB4DW2		277	
Receptacle - USB		USB Black	PSB4URB1		438	Each USB receptacle has 2 USB power ports. There is a 13 USB Receptacle limit for each infeed, even on 2 circuit systems. The last digit in the model code indicates the circuit number.
		USB Gray	PSB4URG1		460	
		USB White	PSB4URW1		460	
Jumpers		Metal Conduit	PSB4JMC	(XXX)	2/inch	CET is used to configure jumper quantities and individual lengths based on layout and infeed location. Any fraction of an inch is rounded up for pricing purposes. Jumper material selection is based on building and local requirements. Please refer to your installer and local code requirements to specify the correct option for your needs. Default jumper material is Metal Conduit. Total jumper pricing can be estimated using the the total length of screens with power in a layout. Add up the width of screens that have receptacles, jumpers, and infeeds. See example on pg 14.
		Non-Metallic Liquid Tight Conduit	PSB4JLT	(XXX)	2/inch	
		Metallic Liquid Tight Conduit	PSB4JLM	(XXX)	2/inch	
Connectors		H-Connector	PSB4CHF		32	An H-Connector must be used in a straight screen to split power, joining two jumpers together. A Receptacle Connector is used to connect a receptacle or side-infeed to an H-Connector. CET will determine actual parts and quantities needed to create the layout.
		Receptacle Connector	PSB4CRM		19	

To Quick Quote Select Below (For Budgetary Purposes Only, for precise pricing obtain from CET)

1. Select Infeed type. 2. Select Receptacle type and quantity. 3. Add up screen widths that have Receptacles, Jumpers, and Infeeds. 4. Add Connectors

Please refer to each component description for specific instructions and guidelines. For an accurate quote, use CET or reach out to our team at designapplication@stylexdesign.com

Still Screens

SPECIFICATION GUIDE: POWER LAYOUT EXAMPLE

EXAMPLE	SPECIFICATION STEPS	COMPONENT	MODEL OPTIONS	MODEL CODE	PRICE	QTY	EXTENDED COST
	A Step 1 Identify infeed location and type. Please follow the specification guidelines on page 13 .	Infeed Hardwired, Side		PSB4IHS072	291	1	280
	B Step 2 Identify receptacle locations and select options and quantities. Please follow the specification guidelines on page 13 .	Receptacle Duplex	Duplex Black	PSB4DB1	267	2	534
		Receptacle USB	USB Black	PSB4URB	460	2	920
	C Step 3 Add up screen widths with power and select which jumper type is appropriate based on the specification guidelines on page 13 . For power estimation purposes use the following widths: 15", 24", 36", and 48". Add 12" per corner. Ex. (36" x qty. 5) + (48" x qty. 3) = 324" CET is used to configure jumper quantities and individual lengths based on layout and infeed location. Any fraction of an inch is rounded up for pricing purposes.	Jumper	Liquid Tight	PSB4JLT324	2/inch	372	744
	D Step 4 Add up quantities of H-Connectors and Receptacle connectors that were used to split power. Please follow the specification guidelines on page 13 .	Power Split Connectors	H-Connector	PSB4CHF	32	3	96
Receptacle Connector			PSB4CRM	19	3	57	
TOTAL COST							2,631

To Quick Quote Select Below (For Budgetary Purposes Only, for precise pricing obtain from CET)

1. Select Infeed type.	2. Select Receptacle type and quantity.	3. Add up screen widths that have Receptacles, Jumpers, and Infeeds.	4. Add Connectors	Please refer to each component description for specific instructions and guidelines. For an accurate quote, use CET or reach out to our team at designapplication@stylexdesign.com
○	○	○	○	

Still Screens

SPECIFICATION GUIDE: HOW TO ORDER

MODEL CODE BREAKDOWN - SCREENS

Sample Model Code: **STU01H59W36CLBLPACOM**

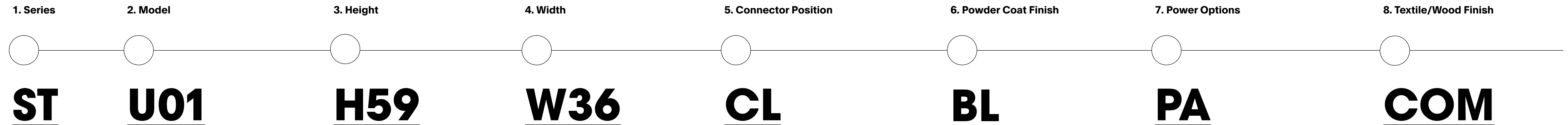

Series
ST STILL

Model
Upholstered Screen
U01 UPHOLSTERED SCREEN
U02 TRANSITION, RADIUS
U10 END CAP, RADIUS
U20 90 DEGREE CORNER
U21 120 DEGREE CORNER
U22 3-WAY T CORNER
U23 3-WAY Y CORNER
U24 4-WAY CORNER

Wood Screen
W01 WOOD SCREEN
W02 90 DEGREE CORNER

Height
H48 48"H
H59 59"H
H70 70"H

Width
W15 15"W
W24 24"W
W36 36"W
W48 48"W

Note: W48 only available for Upholstered Screens

Connector Position
CL LEFT CONNECTOR ONLY
CR RIGHT CONNECTOR ONLY
~ BOTH CONNECTORS
LL LOW CONNECTOR, LEFT
LR LOW CONNECTOR, RIGHT
LB LOW CONNECTOR, BOTH
CF NO CONNECTOR

Powder Coat Finish
Standard Powder Coat
BL BLUE
BM BLACK MATTE
CP CHAMPAGNE
DB DARK BRONZE
DG DARK GRAY
DP DUSTY PINK
DS DARK SAGE
LG LIGHT GRAY
LL LILAC GRAY
LP LIGHT PISTACHIO
LR LIPSTICK RED
MB MIDNIGHT BLUE
MG MEADOW GREEN
MK MILK
MS METALLIC SILVER
NK NICKEL
OC OCHRE
PY PALE YELLOW
RO RED ORANGE
RR RUSTY RED
SB SOFT BLUE
SD SAND
TC TERRACOTTA
TP TAUPE

Power Options
PA POWER POSITION A
PB POWER POSITION B
~ NO POWER
PS POWER SPLIT
IE INFEEED END

Textile Grades
COM CUSTOMER'S OWN MATERIAL
A GRADE A
B GRADE B
C GRADE C
D GRADE D
E GRADE E
F GRADE F
G GRADE G
H GRADE H
I GRADE I
J GRADE J
K GRADE K
L GRADE L
M GRADE M

Wood Finish
SW81 OAK
SW83 NATURAL MAPLE
SW85 WALNUT
SW87 OPAQUE BLACK

Still Screens

SPECIFICATION GUIDE: HOW TO ORDER

MODEL CODE BREAKDOWN - BASES & ACCESSORIES

Sample Model Code: **STB01BL**

1. Series

2. Model

3. Powder Coat Finish

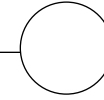
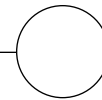
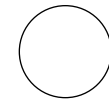

ST

B01

BL

Series

ST STILL

Model

Base

B01 SMALL BASE
B02 LARGE BASE
B03 LARGE BASE, MID

Accessories

A01 COAT HOOK
A02 WHITE BOARD

Note: White board only available in dry erase paint.

Powder Coat Finish

Standard Powder Coat

BL BLUE
BM BLACK MATTE
CP CHAMPAGNE
DB DARK BRONZE
DG DARK GRAY
DP DUSTY PINK
DS DARK SAGE
LG LIGHT GRAY
LL LILAC GRAY
LP LIGHT PISTACHIO
LR LIPSTICK RED
MB MIDNIGHT BLUE
MG MEADOW GREEN
MK MILK
MS METALLIC SILVER
NK NICKEL
OC OCHRE
PY PALE YELLOW
RO RED ORANGE
RR RUSTY RED
SB SOFT BLUE
SD SAND
TC TERRACOTTA
TP TAUPE

Still Screens

UPHOLSTERED SCREENS: 48IN HEIGHT

Textile Upholstery Grades

TITLE	SERIES	MODEL	HEIGHT	WIDTH	DIMENSIONS	YDG	COM	A	B	C	D	E	F	G	H	I	J	K	L	M
Upholstered Screen, 48in Height, 15in Width	ST	U01	H48	W15	15W x 1.88D x 48H	1.7	899	1,020	1,087	1,150	1,216	1,282	1,354	1,426	1,512	1,620	1,753	1,883	2,016	2,147
Upholstered Screen, 48in Height, 24in Width	ST	U01	H48	W24	24.5W x 1.88D x 48H	3.3	1,035	1,276	1,410	1,537	1,669	1,802	1,946	2,090	2,261	2,479	2,745	3,006	3,270	3,530
Upholstered Screen, 48in Height, 36in Width	ST	U01	H48	W36	36.4W x 1.88D x 48H	3.3	1,274	1,516	1,649	1,777	1,909	2,040	2,186	2,331	2,502	2,720	2,984	3,245	3,510	3,771
Upholstered Screen, 48in Height, 48in Width	ST	U01	H48	W48	48W x 1.88D x 48H	3.3	1,326	1,567	1,699	1,828	1,960	2,092	2,236	2,382	2,552	2,771	3,035	3,296	3,559	3,821

To Order Select Below

1. Series/Model/Height

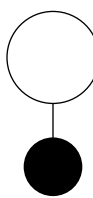

STU01H48

Still Upholstered Screen, 48in Height

2. Width

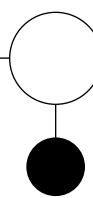

Width

W15	15" W
W24	24" W
W36	36" W
W48	48" W

3. Connectors

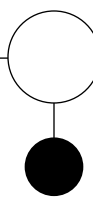

Connectors

CL	LEFT CONNECTOR ONLY
CR	RIGHT CONNECTOR ONLY
CF	NO CONNECTOR

A connector is considered Left or Right when facing Side A. 48in screens include low connectors on both sides as a default. CF - No Connector is not available on all sizes. Refer to [pages 8-10](#) for layout rules.

4. Baseboard Finish

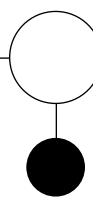

Standard Powder Coated Metal

BL	BLUE	MG	MEADOW GREEN
BM	BLACK MATTE	MK	MILK
CP	CHAMPAGNE	MS	METALLIC SILVER
DB	DARK BRONZE	NK	NICKEL
DG	DARK GRAY	OC	OCHRE
DP	DUSTY PINK	PY	PALE YELLOW
DS	DARK SAGE	RO	RED ORANGE
LG	LIGHT GRAY	RR	RUSTY RED
LL	LILAC GRAY	SB	SOFT BLUE
LP	LIGHT PISTACHIO	SD	SAND
LR	LIPSTICK RED	TC	TERRACOTTA
MB	MIDNIGHT BLUE	TP	TAUPE

5. Power

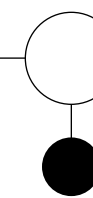

Power

PA	POWER POSITION A
PB	POWER POSITION B
PS	POWER SPLIT
IE	INFEEED END

Refer to [pages 11-14](#) for an explanation of Power Selection.

PS is only required when power is splitting in a 24"W screen.

6. Upholstery

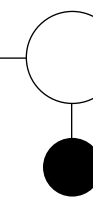

Upholstery

See general information section for details on textile program and COM/COL information.

Still textiles must be applied up the roll.

For tackability, please confirm your textile is tackable directly with the manufacturer.

Still Screens

UPHOLSTERED SCREENS: 59IN HEIGHT

Textile Upholstery Grades

TITLE	SERIES	MODEL	HEIGHT	WIDTH	DIMENSIONS	YDG	COM	A	B	C	D	E	F	G	H	I	J	K	L	M
Upholstered Screen, 59in Height, 15in Width	ST	U01	H59	W15	15W x 1.88D x 59H	2.2	955	1,115	1,203	1,288	1,376	1,464	1,560	1,657	1,771	1,917	2,092	2,267	2,443	2,618
Upholstered Screen, 59in Height, 24in Width	ST	U01	H59	W24	24.5W x 1.88D x 59H	3.9	1,127	1,410	1,564	1,713	1,868	2,022	2,190	2,358	2,558	2,812	3,121	3,425	3,734	4,038
Upholstered Screen, 59in Height, 36in Width	ST	U01	H59	W36	36.4W x 1.88D x 59H	3.9	1,388	1,669	1,825	1,974	2,128	2,283	2,450	2,619	2,818	3,072	3,381	3,686	3,995	4,299
Upholstered Screen, 59in Height, 48in Width	ST	U01	H59	W48	48W x 1.88D x 59H	3.9	1,449	1,730	1,884	2,034	2,188	2,343	2,512	2,680	2,879	3,135	3,443	3,747	4,056	4,361

To Order Select Below

1. Series/Model/Height

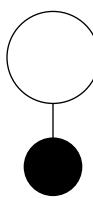

STU01H59

Still Upholstered Screen, 59in Height

2. Width

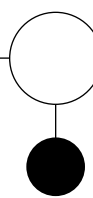

Width

W15	15" W
W24	24" W
W36	36" W
W48	48" W

3. Connectors

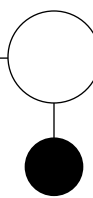

Connectors

CL	LEFT CONNECTOR ONLY
CR	RIGHT CONNECTOR ONLY
LL	LOW CONNECTOR, LEFT
LR	LOW CONNECTOR, RIGHT
LB	LOW CONNECTOR, BOTH
CF	NO CONNECTOR

A connector is considered Left or Right when facing Side A. 59in screens include two upper connectors per side as a default. "Low Connector" is specified when connecting to a different height screen. CF - No Connector is not available on all sizes. Refer to [pages 8-10](#) for layout rules.

4. Baseboard Finish

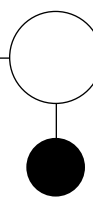

Standard Powder Coated Metal

BL	BLUE	MG	MEADOW GREEN
BM	BLACK MATTE	MK	MILK
CP	CHAMPAGNE	MS	METALLIC SILVER
DB	DARK BRONZE	NK	NICKEL
DG	DARK GRAY	OC	OCHRE
DP	DUSTY PINK	PY	PALE YELLOW
DS	DARK SAGE	RO	RED ORANGE
LG	LIGHT GRAY	RR	RUSTY RED
LL	LILAC GRAY	SB	SOFT BLUE
LP	LIGHT PISTACHIO	SD	SAND
LR	LIPSTICK RED	TC	TERRACOTTA
MB	MIDNIGHT BLUE	TP	TAUPE

5. Power

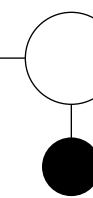

Power

PA	POWER POSITION A
PB	POWER POSITION B
PS	POWER SPLIT
IE	INFEEED END

Refer to [pages 11-14](#) for an explanation of Power Selection.

PS is only required when power is splitting in a 24"W screen.

6. Upholstery

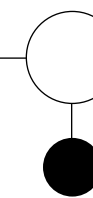

Upholstery

See general information section for details on textile program and COM/COL information.

Still textiles must be applied up the roll.

For tackability, please confirm your textile is tackable directly with the manufacturer.

Still Screens

UPHOLSTERED SCREENS: 70IN HEIGHT

Textile Upholstery Grades

TITLE	SERIES	MODEL	HEIGHT	WIDTH	DIMENSIONS	YDG	COM	A	B	C	D	E	F	G	H	I	J	K	L	M
Upholstered Screen, 70in Height, 15in Width	ST	U01	H70	W15	15W x 1.88D x 70H	2.8	1,035	1,237	1,347	1,455	1,564	1,675	1,794	1,915	2,057	2,239	2,460	2,677	2,896	3,115
Upholstered Screen, 70in Height, 24in Width	ST	U01	H70	W24	24.5W x 1.88D x 70H	5.0	1,205	1,567	1,766	1,958	2,157	2,356	2,571	2,787	3,043	3,371	3,769	4,159	4,556	4,948
Upholstered Screen, 70in Height, 36in Width	ST	U01	H70	W36	36.4W x 1.88D x 70H	5.0	1,512	1,873	2,073	2,265	2,463	2,662	2,878	3,094	3,350	3,676	4,075	4,465	4,863	5,253
Upholstered Screen, 70in Height, 48in Width	ST	U01	H70	W48	48W x 1.88D x 70H	5.0	1,598	1,961	2,161	2,354	2,551	2,749	2,966	3,182	3,438	3,765	4,162	4,554	4,951	5,341

To Order Select Below

1. Series/Model/Height

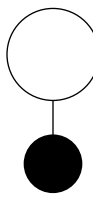

STU01H70

Still Upholstered Screen, 70in Height

2. Width

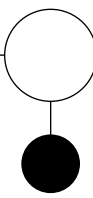

Width

W15	15" W
W24	24" W
W36	36" W
W48	48" W

3. Connectors

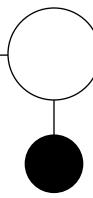

Connectors

CL	LEFT CONNECTOR ONLY
CR	RIGHT CONNECTOR ONLY
LL	LOW CONNECTOR, LEFT
LR	LOW CONNECTOR, RIGHT
LB	LOW CONNECTOR, BOTH

A connector is considered Left or Right when facing Side A. 70in screens include two upper connectors per side as a default. "Low Connector" is specified when connecting to a lower height screen. Refer to [pages 8-10](#) for layout rules.

4. Baseboard Finish

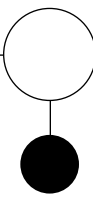

Standard Powder Coated Metal

BL	BLUE	MG	MEADOW GREEN
BM	BLACK MATTE	MK	MILK
CP	CHAMPAGNE	MS	METALLIC SILVER
DB	DARK BRONZE	NK	NICKEL
DG	DARK GRAY	OC	OCHRE
DP	DUSTY PINK	PY	PALE YELLOW
DS	DARK SAGE	RO	RED ORANGE
LG	LIGHT GRAY	RR	RUSTY RED
LL	LILAC GRAY	SB	SOFT BLUE
LP	LIGHT PISTACHIO	SD	SAND
LR	LIPSTICK RED	TC	TERRACOTTA
MB	MIDNIGHT BLUE	TP	TAUPE

5. Power

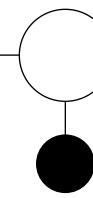

Power

PA	POWER POSITION A
PB	POWER POSITION B
PS	POWER SPLIT
IE	INFEEED END

Refer to [pages 11-14](#) for an explanation of Power Selection.

PS is only required when power is splitting in a 24"W screen.

6. Upholstery



Upholstery

See general information section for details on textile program and COM/COL information.



Still textiles must be applied up the roll.

For tackability, please confirm your textile is tackable directly with the manufacturer.

Still Screens

UPHOLSTERED SCREENS: TRANSITIONS

Textile Upholstery Grades

TITLE	SERIES	MODEL	HEIGHT	WIDTH	DIMENSIONS	YDG	COM	A	B	C	D	E	F	G	H	I	J	K	L	M
Upholstered Screen, 59in Height, Transition 	ST	U02	H59	W15	15W x 1.88D x 59H	2.2	955	1,115	1,203	1,288	1,376	1,464	1,560	1,657	1,771	1,917	2,092	2,267	2,443	2,618
Upholstered Screen, 70in Height, Transition 	ST	U02	H70	W15	15W x 1.88D x 70H	2.8	1,029	1,229	1,340	1,447	1,558	1,667	1,788	1,907	2,051	2,232	2,452	2,670	2,890	3,108

To Order Select Below

1. Series/Model/Height

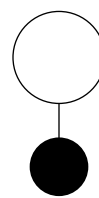

STU02H59

Still Upholstered Screen, 59in Height, Transition

STU02H70

Still Upholstered Screen, 70in Height, Transition

2. Width

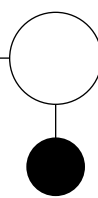

Width

W15 15" W

3. Connectors

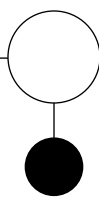

Connectors

CL LEFT CONNECTOR ONLY
LL LOW CONNECTOR, LEFT

The radius is on the right side when facing Side A.

Specify "LL" when connecting to a different height screen on the left.

59H and 70H Transition Screens have a single low connector on the right side as a default. "LR" and "LB" are not available.

4. Baseboard Finish

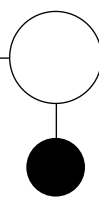

Standard Powder Coated Metal

BL BLUE	MG MEADOW GREEN
BM BLACK MATTE	MK MILK
CP CHAMPAGNE	MS METALLIC SILVER
DB DARK BRONZE	NK NICKEL
DG DARK GRAY	OC OCHRE
DP DUSTY PINK	PY PALE YELLOW
DS DARK SAGE	RO RED ORANGE
LG LIGHT GRAY	RR RUSTY RED
LL LILAC GRAY	SB SOFT BLUE
LP LIGHT PISTACHIO	SD SAND
LR LIPSTICK RED	TC TERRACOTTA
MB MIDNIGHT BLUE	TP TAUPE

5. Power

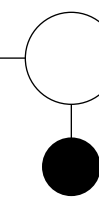

Power

IE INFEEED END (CORDED)

Refer to **pages 11-14** for an explanation of Power Selection.

PS is only required when power is splitting in a 24"W screen.

6. Upholstery

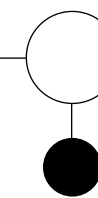

Upholstery

See general information section for details on textile program and COM/COL information.

Still textiles must be applied up the roll.

For tackability, please confirm your textile is tackable directly with the manufacturer.

Still Screens

UPHOLSTERED SCREENS: END CAP

Textile Upholstery Grades

TITLE	SERIES	MODEL	HEIGHT	WIDTH	DIMENSIONS	YDG	COM	A	B	C	D	E	F	G	H	I	J	K	L	M
Upholstered Screen, 48in Height, End Cap	ST	U10	H48		8W x 1.88D x 48H	1.7	558	678	744	809	875	941	1,013	1,086	1,171	1,280	1,412	1,543	1,675	1,805
Upholstered Screen, 59in Height, End Cap	ST	U10	H59		8W x 1.88D x 59H	2.2	596	757	846	932	1,020	1,108	1,204	1,300	1,414	1,559	1,737	1,909	2,087	2,259
Upholstered Screen, 70in Height, End Cap	ST	U10	H70		8W x 1.88D x 70H	2.8	632	832	943	1,049	1,161	1,270	1,390	1,510	1,654	1,835	2,055	2,272	2,493	2,710

To Order Select Below

1. Series/Model/Height

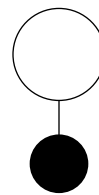

STU10H48

Still Upholstered Screen, 48in Height, End Cap

STU10H59

Still Upholstered Screen, 59in Height, End Cap

STU10H70

Still Upholstered Screen, 70in Height, End Cap

2. Connectors

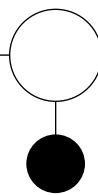

No Connectors Required

The radius is on the right side when facing Side A. Refer to [pages 8-10](#) for layout rules.

3. Baseboard Finish

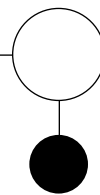

Standard Powder Coated Metal

BL BLUE

BM BLACK MATTE

CP CHAMPAGNE

DB DARK BRONZE

DG DARK GRAY

DP DUSTY PINK

DS DARK SAGE

LG LIGHT GRAY

LL LILAC GRAY

LP LIGHT PISTACHIO

LR LIPSTICK RED

MB MIDNIGHT BLUE

MG MEADOW GREEN

MK MILK

MS METALLIC SILVER

NK NICKEL

OC OCHRE

PY PALE YELLOW

RO RED ORANGE

RR RUSTY RED

SB SOFT BLUE

SD SAND

TC TERRACOTTA

TP TAUPE

4. Power

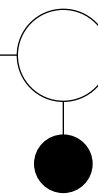

Power

IE INFEEED END (CORDED)

Refer to [pages 11-14](#) for an explanation of Power Selection.

PS is on Still Screens when they are supplied in a 24"W screen.

Endcaps are not tackable.

5. Upholstery

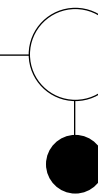

Upholstery

See general information section for details on textile program and COM/COL information.

Still textiles must be applied up the roll.

For tackability, please confirm your textile is tackable directly with the manufacturer.

Still Screens

UPHOLSTERED SCREENS: 90 DEGREE CORNER

Textile Upholstery Grades

TITLE	SERIES	MODEL	HEIGHT	WIDTH	DIMENSIONS	YDG	COM	A	B	C	D	E	F	G	H	I	J	K	L	M
Upholstered Screen, 48in Height, 90 Degree	ST	U20	H48		8W x 8D x 48H	1.7	820	939	1,006	1,070	1,136	1,202	1,273	1,346	1,432	1,540	1,672	1,803	1,935	2,066
Upholstered Screen, 59in Height, 90 Degree	ST	U20	H59		8W x 8D x 59H	2.2	986	1,147	1,236	1,322	1,410	1,498	1,593	1,689	1,803	1,948	2,125	2,298	2,475	2,649
Upholstered Screen, 70in Height, 90 Degree	ST	U20	H70		8W x 8D x 70H	2.8	1,028	1,228	1,338	1,446	1,556	1,666	1,787	1,905	2,049	2,230	2,450	2,669	2,889	3,106

To Order Select Below

1. Series/Model/Height

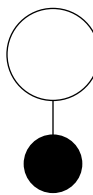

STU20H48

Still Upholstered Screen, 48in Height, 90° Corner

STU20H59

Still Upholstered Screen, 59in Height, 90° Corner

STU20H70

Still Upholstered Screen, 70in Height, 90° Corner

2. Connectors

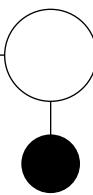

No Connectors Required

Refer to [pages 8-10](#) for layout rules.

3. Baseboard Finish

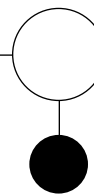

Standard Powder Coated Metal

BL BLUE

BM BLACK MATTE

CP CHAMPAGNE

DB DARK BRONZE

DG DARK GRAY

DP DUSTY PINK

DS DARK SAGE

LG LIGHT GRAY

LL LILAC GRAY

LP LIGHT PISTACHIO

LR LIPSTICK RED

MB MIDNIGHT BLUE

MG MEADOW GREEN

MK MILK

MS METALLIC SILVER

NK NICKEL

OC OCHRE

PY PALE YELLOW

RO RED ORANGE

RR RUSTY RED

SB SOFT BLUE

SD SAND

TC TERRACOTTA

TP TAUPE

4. Power

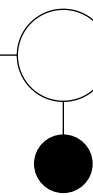

Power

IE INFEEED END (CORDED)

Refer to [pages 11-14](#) for an explanation of Power Selection.

PS is on Still Textiles when the roll is unrolled in a 24"W screen.

Corners are not tackable.

5. Upholstery

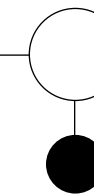

Upholstery

See general information section for details on textile program and COM/COL information.

Still textiles must be applied up the roll.

For tackability, please confirm your textile is tackable directly with the manufacturer.

Still Screens

UPHOLSTERED SCREENS: 120 DEGREE CORNER

Textile Upholstery Grades

TITLE	SERIES	MODEL	HEIGHT	WIDTH	DIMENSIONS	YDG	COM	A	B	C	D	E	F	G	H	I	J	K	L	M
Upholstered Screen, 48in Height, 120 Degree	ST	U21	H48		5.2W x 7.3D x 48H	1.7	751	872	938	1,003	1,068	1,135	1,206	1,279	1,366	1,473	1,606	1,737	1,869	2,000
Upholstered Screen, 59in Height, 120 Degree	ST	U21	H59		5.2W x 7.3D x 59H	2.2	866	1,026	1,115	1,200	1,288	1,376	1,473	1,568	1,683	1,828	2,005	2,179	2,356	2,529
Upholstered Screen, 70in Height, 120 Degree	ST	U21	H70		5.2W x 7.3D x 70H	2.8	905	1,107	1,218	1,325	1,434	1,545	1,664	1,785	1,927	2,109	2,330	2,547	2,767	2,985

To Order Select Below

1. Series/Model/Height

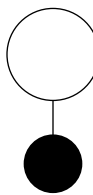

STU21H48

Still Upholstered Screen, 48in Height, 120° Corner

STU21H59

Still Upholstered Screen, 59in Height, 120° Corner

STU21H70

Still Upholstered Screen, 70in Height, 120° Corner

2. Connectors

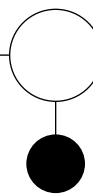

No Connectors Required

Refer to [pages 8-10](#) for layout rules.

3. Baseboard Finish

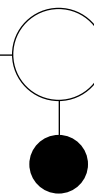

Standard Powder Coated Metal

BL BLUE

BM BLACK MATTE

CP CHAMPAGNE

DB DARK BRONZE

DG DARK GRAY

DP DUSTY PINK

DS DARK SAGE

LG LIGHT GRAY

LL LILAC GRAY

LP LIGHT PISTACHIO

LR LIPSTICK RED

MB MIDNIGHT BLUE

MG MEADOW GREEN

MK MILK

MS METALLIC SILVER

NK NICKEL

OC OCHRE

PY PALE YELLOW

RO RED ORANGE

RR RUSTY RED

SB SOFT BLUE

SD SAND

TC TERRACOTTA

TP TAUPE

4. Power

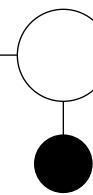

Power

IE INFEEED END (CORDED)

Refer to [pages 11-14](#) for an explanation of Power Selection.

PS is on Still Textiles when the roll is in a 24"W screen.

Corners are not tackable.

5. Upholstery

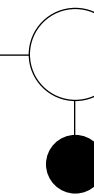

Upholstery

See general information section for details on textile program and COM/COL information.

Still textiles must be applied up the roll.

For tackability, please confirm your textile is tackable directly with the manufacturer.

Still Screens

UPHOLSTERED SCREENS: 3-WAY T CORNER

Textile Upholstery Grades

TITLE	SERIES	MODEL	HEIGHT	WIDTH	DIMENSIONS	YDG	COM	A	B	C	D	E	F	G	H	I	J	K	L	M
Upholstered Screen, 48in Height, 3-Way T	ST	U22	H48		8W x 14.13D x 48H	1.7	1,223	1,345	1,411	1,475	1,540	1,607	1,679	1,750	1,837	1,945	2,078	2,208	2,340	2,471
Upholstered Screen, 59in Height, 3-Way T	ST	U22	H59		8W x 14.13D x 59H	2.2	1,468	1,631	1,717	1,803	1,892	1,980	2,076	2,170	2,286	2,430	2,607	2,781	2,958	3,130
Upholstered Screen, 70in Height, 3-Way T	ST	U22	H70		8W x 14.13D x 70H	2.8	1,535	1,738	1,847	1,955	2,065	2,176	2,295	2,416	2,558	2,739	2,961	3,178	3,398	3,615

To Order Select Below

1. Series/Model/Height

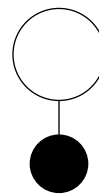

STU22H48

Still Upholstered Screen, 48in Height, 3-Way T

STU22H59

Still Upholstered Screen, 59in Height, 3-Way T

STU22H70

Still Upholstered Screen, 70in Height, 3-Way T

2. Connectors

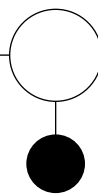

No Connectors Required

Refer to [pages 8-10](#) for layout rules.

3. Baseboard Finish

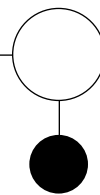

Standard Powder Coated Metal

BL BLUE

BM BLACK MATTE

CP CHAMPAGNE

DB DARK BRONZE

DG DARK GRAY

DP DUSTY PINK

DS DARK SAGE

LG LIGHT GRAY

LL LILAC GRAY

LP LIGHT PISTACHIO

LR LIPSTICK RED

MB MIDNIGHT BLUE

MG MEADOW GREEN

MK MILK

MS METALLIC SILVER

NK NICKEL

OC OCHRE

PY PALE YELLOW

RO RED ORANGE

RR RUSTY RED

SB SOFT BLUE

SD SAND

TC TERRACOTTA

TP TAUPE

4. Power

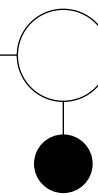

Power

IE INFEEED END (CORDED)

Refer to [pages 11-14](#) for an explanation of Power Selection.

PS is on Still Textiles when the roll is applied in a 24"W screen.

Corners are not tackable.

5. Upholstery

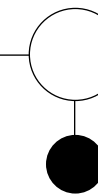

Upholstery

See general information section for details on textile program and COM/COL information.

Still textiles must be applied up the roll.

For tackability, please confirm your textile is tackable directly with the manufacturer.

Still Screens

UPHOLSTERED SCREENS: 3-WAY Y CORNER

Textile Upholstery Grades

TITLE	SERIES	MODEL	HEIGHT	WIDTH	DIMENSIONS	YDG	COM	A	B	C	D	E	F	G	H	I	J	K	L	M
Upholstered Screen, 48in Height, 3-Way Y	ST	U23	H48		8.5W x 8.5D x 48H	1.7	1,169	1,289	1,356	1,420	1,486	1,552	1,623	1,696	1,783	1,891	2,023	2,154	2,286	2,417
Upholstered Screen, 59in Height, 3-Way Y	ST	U23	H59		8.5W x 8.5D x 59H	2.2	1,322	1,481	1,569	1,656	1,743	1,831	1,928	2,024	2,138	2,284	2,461	2,634	2,811	2,984
Upholstered Screen, 70in Height, 3-Way Y	ST	U23	H70		8.5W x 8.5D x 70H	2.8	1,384	1,586	1,696	1,802	1,914	2,023	2,142	2,264	2,406	2,589	2,808	3,025	3,246	3,463

To Order Select Below

1. Series/Model/Height

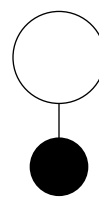

STU23H48

Still Upholstered Screen, 48in Height, 3-Way Y

STU23H59

Still Upholstered Screen, 59in Height, 3-Way Y

STU23H70

Still Upholstered Screen, 70in Height, 3-Way Y

2. Connectors

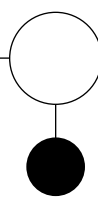

No Connectors Required

Refer to [pages 8-10](#) for layout rules.

3. Baseboard Finish

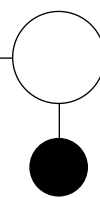

Standard Powder Coated Metal

BL BLUE

BM BLACK MATTE

CP CHAMPAGNE

DB DARK BRONZE

DG DARK GRAY

DP DUSTY PINK

DS DARK SAGE

LG LIGHT GRAY

LL LILAC GRAY

LP LIGHT PISTACHIO

LR LIPSTICK RED

MB MIDNIGHT BLUE

MG MEADOW GREEN

MK MILK

MS METALLIC SILVER

NK NICKEL

OC OCHRE

PY PALE YELLOW

RO RED ORANGE

RR RUSTY RED

SB SOFT BLUE

SD SAND

TC TERRACOTTA

TP TAUPE

4. Power

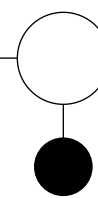

Power

IE INFEEED END (CORDED)

Refer to [pages 11-14](#) for an explanation of Power Selection.

PS is on Still Screens where applicable in a 24"W screen.

Corners are not tackable.

5. Upholstery

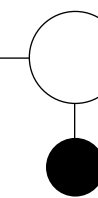

Upholstery

See general information section for details on textile program and COM/COL information.

Still textiles must be applied up the roll.

For tackability, please confirm your textile is tackable directly with the manufacturer.

Still Screens

UPHOLSTERED SCREENS: 4-WAY CORNER

Textile Upholstery Grades

TITLE	SERIES	MODEL	HEIGHT	WIDTH	DIMENSIONS	YDG	COM	A	B	C	D	E	F	G	H	I	J	K	L	M
Upholstered Screen, 48in Height, 4-Way	ST	U24	H48		14W x 14D x 48H	2.2	1,650	1,812	1,899	1,985	2,074	2,162	2,257	2,354	2,467	2,612	2,789	2,963	3,140	3,313
Upholstered Screen, 59in Height, 4-Way	ST	U24	H59		14W x 14D x 59H	2.8	1,952	2,154	2,265	2,371	2,480	2,592	2,711	2,831	2,973	3,154	3,376	3,594	3,815	4,031
Upholstered Screen, 70in Height, 4-Way	ST	U24	H70		14W x 14D x 70H	2.8	2,040	2,243	2,354	2,462	2,571	2,682	2,801	2,921	3,064	3,246	3,466	3,684	3,904	4,123

To Order Select Below

1. Series/Model/Height

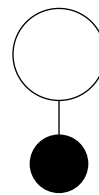

STU24H48

Still Upholstered Screen, 48in Height, 4-Way

STU24H59

Still Upholstered Screen, 59in Height, 4-Way

STU24H70

Still Upholstered Screen, 70in Height, 4-Way

2. Connectors

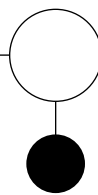

No Connectors Required

Refer to [pages 8-10](#) for layout rules.

3. Baseboard Finish

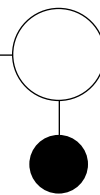

Standard Powder Coated Metal

BL BLUE

BM BLACK MATTE

CP CHAMPAGNE

DB DARK BRONZE

DG DARK GRAY

DP DUSTY PINK

DS DARK SAGE

LG LIGHT GRAY

LL LILAC GRAY

LP LIGHT PISTACHIO

LR LIPSTICK RED

MB MIDNIGHT BLUE

MG MEADOW GREEN

MK MILK

MS METALLIC SILVER

NK NICKEL

OC OCHRE

PY PALE YELLOW

RO RED ORANGE

RR RUSTY RED

SB SOFT BLUE

SD SAND

TC TERRACOTTA

TP TAUPE

4. Power

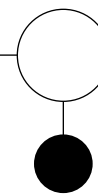

Power

IE INFEEED END (CORDED)

Refer to [pages 11-14](#) for an explanation of Power Selection.

PS is on Still Textiles when the roll is in a 24"W screen.

Corners are not tackable.

5. Upholstery

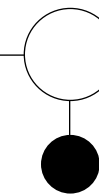

Upholstery



See general information section for details on textile program and COM/COL information.

Still textiles must be applied up the roll.

For tackability, please confirm your textile is tackable directly with the manufacturer.

Still Screens

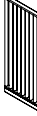
WOOD SCREENS: 48IN HEIGHT

							Solid Wood
TITLE	SERIES	MODEL	HEIGHT	WIDTH	DIMENSIONS		P1
Wood Screen, 48in Height, 15in Width 	ST	W01	H48	W15	15W x 1.88D x 48H		1,450
Wood Screen, 48in Height, 24in Width 	ST	W01	H48	W24	24.5W x 1.88D x 48H		1,971
Wood Screen, 48in Height, 36in Width 	ST	W01	H48	W36	36.4W x 1.88D x 48H		2,650

To Order Select Below

1. Series/Model/Height

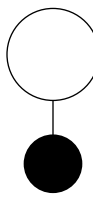

STW01H48

Still Wood Screen, 48in Height

2. Width

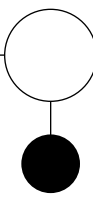

Width

W15 15" W

W24 24" W

W36 36" W

3. Connectors

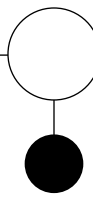

Connectors

CL LEFT CONNECTOR ONLY

CR RIGHT CONNECTOR ONLY

CF NO CONNECTOR

A connector is considered Left or Right when facing Side A. 48in screens include low connectors on both sides as a default. CF - No Connector is not available on all sizes. Refer to [pages 8-10](#) for layout rules.

4. Baseboard Finish

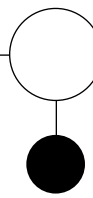

Standard Powder Coated Metal

BL BLUE

BM BLACK MATTE

CP CHAMPAGNE

DB DARK BRONZE

DG DARK GRAY

DP DUSTY PINK

DS DARK SAGE

LG LIGHT GRAY

LL LILAC GRAY

LP LIGHT PISTACHIO

LR LIPSTICK RED

MB MIDNIGHT BLUE

MG MEADOW GREEN

MK MILK

MS METALLIC SILVER

NK NICKEL

OC OCHRE

PY PALE YELLOW

RO RED ORANGE

RR RUSTY RED

SB SOFT BLUE

SD SAND

TC TERRACOTTA

TP TAUPE

5. Power

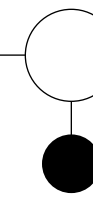

Power

PA POWER POSITION A

PB POWER POSITION B

PS POWER SPLIT

IE INFEEED END

Refer to [pages 11-14](#) for an explanation of Power Selection.

PS is only required when power is splitting in a 24"W screen.

6. Wood Finish



Wood Finish

SW81 OAK

SW83 NATURAL MAPLE

SW85 WALNUT

SW87 OPAQUE BLACK

15W

24W

36W

+218

+340

+494

Still Screens

WOOD SCREENS: 59IN HEIGHT

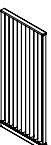
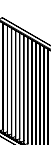
							Solid Wood
TITLE	SERIES	MODEL	HEIGHT	WIDTH	DIMENSIONS		P1
Wood Screen, 59in Height, 15in Width 	ST	W01	H59	W15	15W x 1.88D x 59H		1,581
Wood Screen, 59in Height, 24in Width 	ST	W01	H59	W24	24.5W x 1.88D x 59H		2,168
Wood Screen, 59in Height, 36in Width 	ST	W01	H59	W36	36.4W x 1.88D x 59H		2,932

To Order Select Below

1. Series/Model/Height

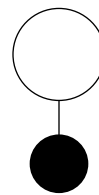

STW01H59

**Still
Wood Screen,
59in Height**

2. Width

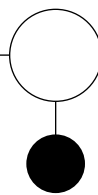

Width

W15 15" W

W24 24" W

W36 36" W

3. Connectors

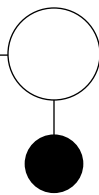

Connectors

CL LEFT CONNECTOR ONLY

CR RIGHT CONNECTOR ONLY

LL LOW CONNECTOR, LEFT

LR LOW CONNECTOR, RIGHT

LB LOW CONNECTOR, BOTH

CF NO CONNECTOR

A connector is considered Left or Right when facing Side A. 59in screens include two upper connectors per side as a default. "Low Connector" is specified when connecting to a different height screen. CF - No Connector is not available on all sizes. Refer to **X** for layout rules.

4. Baseboard Finish

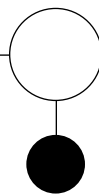

Standard Powder Coated Metal

BL BLUE

BM BLACK MATTE

CP CHAMPAGNE

DB DARK BRONZE

DG DARK GRAY

DP DUSTY PINK

DS DARK SAGE

LG LIGHT GRAY

LL LILAC GRAY

LP LIGHT PISTACHIO

LR LIPSTICK RED

MB MIDNIGHT BLUE

MG MEADOW GREEN

MK MILK

MS METALLIC SILVER

NK NICKEL

OC OCHRE

PY PALE YELLOW

RO RED ORANGE

RR RUSTY RED

SB SOFT BLUE

SD SAND

TC TERRACOTTA

TP TAUPE

5. Power

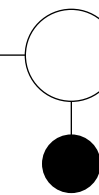

Power

PA POWER POSITION A

PB POWER POSITION B

PS POWER SPLIT

IE INFEEED END

Refer to **pages 11-14** for an explanation of Power Selection.

PS is only required when power is splitting in a 24"W screen.

6. Wood Finish

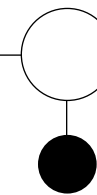

Wood Finish

SW81 OAK

SW83 NATURAL MAPLE

SW85 WALNUT

SW87 OPAQUE BLACK

15W

24W

36W



+285

+451

+661

Still Screens

WOOD SCREENS: 70IN HEIGHT

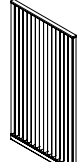
							Solid Wood
TITLE	SERIES	MODEL	HEIGHT	WIDTH	DIMENSIONS		P1
Wood Screen, 70in Height, 15in Width 	ST	W01	H70	W15	15W x 1.88D x 70H		1,730
Wood Screen, 70in Height, 24in Width 	ST	W01	H70	W24	24.5W x 1.88D x 70H		2,414
Wood Screen, 70in Height, 36in Width 	ST	W01	H70	W36	36.4W x 1.88D x 70H		3,293

To Order Select Below

1. Series/Model/Height

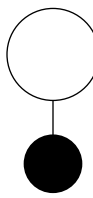

STW01H70

Still Wood Screen, 70in Height

2. Width

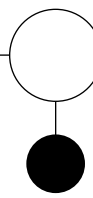

Width

W15	15" W
W24	24" W
W36	36" W

3. Connectors

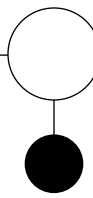

Connectors

CL	LEFT CONNECTOR ONLY
CR	RIGHT CONNECTOR ONLY
LL	LOW CONNECTOR, LEFT
LR	LOW CONNECTOR, RIGHT
LB	LOW CONNECTOR, BOTH

A connector is considered Left or Right when facing Side A. 70in screens include two upper connectors per side as a default. "Low Connector" is specified when connecting to a lower height screen. Refer to [pages 8-10](#) for layout rules.

4. Baseboard Finish

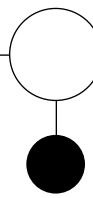

Standard Powder Coated Metal

BL	BLUE	MG	MEADOW GREEN
BM	BLACK MATTE	MK	MILK
CP	CHAMPAGNE	MS	METALLIC SILVER
DB	DARK BRONZE	NK	NICKEL
DG	DARK GRAY	OC	OCHRE
DP	DUSTY PINK	PY	PALE YELLOW
DS	DARK SAGE	RO	RED ORANGE
LG	LIGHT GRAY	RR	RUSTY RED
LL	LILAC GRAY	SB	SOFT BLUE
LP	LIGHT PISTACHIO	SD	SAND
LR	LIPSTICK RED	TC	TERRACOTTA
MB	MIDNIGHT BLUE	TP	TAUPE

5. Power

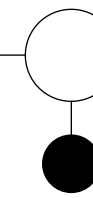

Power

PA	POWER POSITION A
PB	POWER POSITION B
PS	POWER SPLIT
IE	INFEEED END

Refer to [pages 11-14](#) for an explanation of Power Selection.

PS is only required when power is splitting in a 24"W screen.

6. Wood Finish





Wood Finish

		15W	24W	36W
SW81	OAK			
SW83	NATURAL MAPLE			
SW85	WALNUT	+359	+558	+811
SW87	OPAQUE BLACK			

Still Screens

WOOD SCREENS: 90 DEGREE CORNER

							Solid Wood
TITLE	SERIES	MODEL	HEIGHT	WIDTH	DIMENSIONS		P 1
Wood Screen, 48in Height, 90 Degree Corner 	ST	W02	H48		8W x 8D x 48H		1,196
Wood Screen, 59in Height, 90 Degree Corner 	ST	W02	H59		8W x 8D x 59H		1,295
Wood Screen, 70in Height, 90 Degree Corner 	ST	W02	H70		8W x 8D x 70H		1,399

To Order Select Below

1. Series/Model/Height

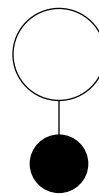

STW02H48

Still Wood Screen, 48in Height, 90° Corner

STW02H59

Still Wood Screen, 59in Height, 90° Corner

STW02H70

Still Wood Screen, 70in Height, 90° Corner

2. Connectors

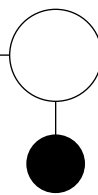

No Connectors Required

Refer to [pages 8-10](#) for layout rules.

3. Baseboard Finish

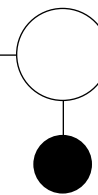

Standard Powder Coated Metal

BL BLUE

BM BLACK MATTE

CP CHAMPAGNE

DB DARK BRONZE

DG DARK GRAY

DP DUSTY PINK

DS DARK SAGE

LG LIGHT GRAY

LL LILAC GRAY

LP LIGHT PISTACHIO

LR LIPSTICK RED

MB MIDNIGHT BLUE

MG MEADOW GREEN

MK MILK

MS METALLIC SILVER

NK NICKEL

OC OCHRE

PY PALE YELLOW

RO RED ORANGE

RR RUSTY RED

SB SOFT BLUE

SD SAND

TC TERRACOTTA

TP TAUPE

4. Wood Finish

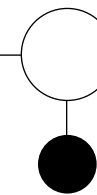

Wood Finish

48H

59H

70H

SW81 OAK

SW83 NATURAL MAPLE

SW85 WALNUT

+184



+225

+283

SW87 OPAQUE BLACK

Still Screens

BASEPLATES AND ACCESSORIES

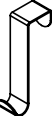
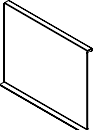
TITLE		SERIES	MODEL	DIMENSIONS	P1
Base, Small		ST	B01	6W x 14D x 0.18H	128
Base, Large		ST	B02	8.5W x 18D x 0.25H	154
Base, Large Mid		ST	B03	9.25W x 18D x 0.25H	154
Accessories, Hook		ST	A01	1.5W x 1.5D x 6.6H	40
Accessories, Whiteboard		ST	A02	36.38W x 2.5D x 29.75H	811

To Order Select Below

1. Series/Model

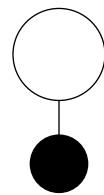

- STB01 SMALL BASEPLATE
- STB02 LARGE BASEPLATE
- STB03 LARGE MID BASEPLATE
- STA01 COAT HOOK
- STA02 WHITE BOARD

The White Board is only available in dry erase paint. Refer to [pages 8-10](#) for layout rules.

2. Baseboard Finish

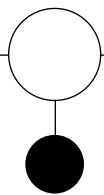

Standard Powder Coated Metal

- | | |
|--------------------|--------------------|
| BL BLUE | MG MEADOW GREEN |
| BM BLACK MATTE | MK MILK |
| CP CHAMPAGNE | MS METALLIC SILVER |
| DB DARK BRONZE | NK NICKEL |
| DG DARK GRAY | OC OCHRE |
| DP DUSTY PINK | PY PALE YELLOW |
| DS DARK SAGE | RO RED ORANGE |
| LG LIGHT GRAY | RR RUSTY RED |
| LL LILAC GRAY | SB SOFT BLUE |
| LP LIGHT PISTACHIO | SD SAND |
| LR LIPSTICK RED | TC TERRACOTTA |
| MB MIDNIGHT BLUE | TP TAUPE |