

stylex

Free Address

PRICE LIST

Effective November 01, 2024

Updated November 06, 2024

General Information

STYLEX PRICE LIST

GENERAL INFORMATION

Terms

Net 30 days from date of invoice,
F. O. B . Delanco, New Jersey.

Damaged Shipments

All Stylex products are carefully inspected before they are packed in sturdy cartons designed to satisfy shipping requirements. Stylex is not responsible for damage in shipment. The transportation company assumes responsibility for delivering products to you in good condition when the bill of lading is signed. You protect yourself by refusing shipments showing damage or shortage until transportation company has noted on the delivery sheet the extent of damage or shortage. Concealed damage should be reported to the carrier as soon as discovered, but no later than 5 days after receiving shipment.

Return/Restocking Policy

Return shipments will not be accepted unless specifically authorized by Stylex in writing. The Return Authorization number should be clearly marked on the carton. The customer returning Stylex products is responsible for return shipping costs. Merchandise must be returned unused. Returned merchandise is subject to a 35% restocking fee.

Special Products

Modifications to standard products will be considered for large runs. Contact factory for price quotations.

Design Changes

In keeping with modern manufacturing advances, Stylex reserves the right to incorporate minor modifications and design changes in products without notice.

Cancellation/Change Order Policy

Regarding requests for order cancellation and/or order modification, please be advised that no charges will be applied before production, unless inventory has been specifically requisitioned to fulfill your order. Once orders proceed to the production phase, they cannot be altered or canceled under any circumstances. All requests for order cancellations or order changes must be submitted in writing and will only be considered valid upon approval by Stylex.

WARRANTY

Except as provided below, Stylex warrants exclusively to the original Purchaser of our product that all parts, under normal use and service, will be free from defects in workmanship and material for a period of ten (10) years from the date of purchase. "Normal use and service" means that the product will be used in a typical office environment for 40-45 hours per week.

This warranty is subject to the following limitations, exclusions and provisions:

Limitations involving materials and components:

Wood components of plywood stacking chairs
(such as Brooks and Welcome)
5 years

Upholstery

(including mesh used for Click, F4, Insight, and Zephyr Mesh)
3 years

SAVA Mesh

10 years

Pneumatic Cylinders

3 years

COM Upholstery

No warranty
Stylex makes every effort to ensure that the COM Upholstery it approves is suitable for the intended use. Nevertheless, we will not warrant, and assume no responsibility for, the durability or tailoring quality of any COM or COL. If you have any concerns about the ultimate appearance of any covering, please order an upholstered sample.

Painted Stack Chair Frames

No Warranty
We will not warrant the finish of painted stack chair frames against damage from stacking. Please order chrome frames for chairs that will be stacked.

Felt Glides

No warranty
Due to the different surfaces on which felt glides may be used, we cannot warrant their durability over time.

If this product fails during normal use and service within the applicable warranty period (other than through normal wear and tear), please submit a warranty claim at stylexdesign.com/warranty-claim/. Quantity, model details, description of issue, and Stylex certified labels are required for submission. PLEASE DO NOT RETURN PARTS OR THE PRODUCT TO STYLEX UNLESS INSTRUCTED TO DO SO BY STYLEX. Stylex will, at its discretion, either repair or replace the defective product or part at no cost. Labor requests must receive approval and will be authorized on a case-by-case basis. We will only reimburse for labor costs directly incurred, excluding any travel-related expenses. Purchaser may be required (at the option of Stylex) to return to Stylex at Purchaser's expense any defective part with all freight or shipping charges prepaid. The foregoing warranty shall be void if the product has been altered or repaired (other than by Stylex). The warranty does not cover damage to the product caused by accident, neglect, misuse, abuse, modification to the product by anyone other than Stylex or damage caused by use of the product for a purpose other than that for which it was designed. This warranty extends only to the original Purchaser of the product.

No Other Warranties

This warranty is in lieu of all other warranties, expressed or implied, including, but not limited to, implied warranties of merchantability and fitness for a particular purpose. The rights and remedies provided herein are the exclusive rights and remedies of the original purchaser of the product.

No Liability For Damages

In no event shall Stylex or its suppliers be responsible or liable for any special, indirect, consequential, or incidental damages. In no event shall the liability of Stylex exceed the actual purchase price paid to Stylex for the product.

Out of Warranty Products

For all products no longer covered by our warranty, please refer to our Design for Durability and Upgradability Policy. Contact your Account Manager if you would like to purchase any replaceable components to further extend the life of any Stylex seating product. This warranty applies to all Stylex products purchased on April 13, 2018, and thereafter.

PRODUCT TAKE BACK PROGRAM

In order to be good stewards of our products, Stylex offers a pathway towards a Product Take Back Program as a more viable solution to the end of our products' originally intended life.

Stylex supports the sustainable programs of ANEW and offers their added value to our clients through a comprehensive take-back solution for surplus office furniture and materials of any kind, in any condition. ANEW is a 501(c)(3) non-profit organization that exists to provide companies with smart, cost effective alternatives for their surplus furniture and other items with the priority of matching it to non- profits, public agencies and the underserved, within the local community of the project site. Corporate Social Responsibility is raised while the impact on the environment is lowered by diverting products and materials otherwise destined for landfill.

Stylex is proud to offer ANEW to customers dedicated to strengthening their community network by repurposing their furniture, fixtures and architectural materials to those in need. In 2014, Stylex committed to making this relationship a part of our strategic sales strategy. Visit www.anewfound.org to find out more.

To initiate a Product Take Back strategy through ANEW, contact Stylex Account Management at 800-257-5742.

For other end of life recovery options, please see our Product Disassembly Instructions and End of Life Recovery Options documents available on our website in the resources section of each product in our line.

FREIGHT PROGRAM

Freight charges will be calculated as a percentage of the net product price and added to the invoice at the time of shipment. The continental United States has been divided into three zones. Please use the map below to determine freight charges for the product's destination. Minimum freight charge is \$250. Please let us know if you will be shipping to a residential address or require inside delivery as this requires an additional fee. Also please note we need to be made aware if a liftgate is required prior to delivery. If any requests are made at the time of delivery, applicable charges will apply.

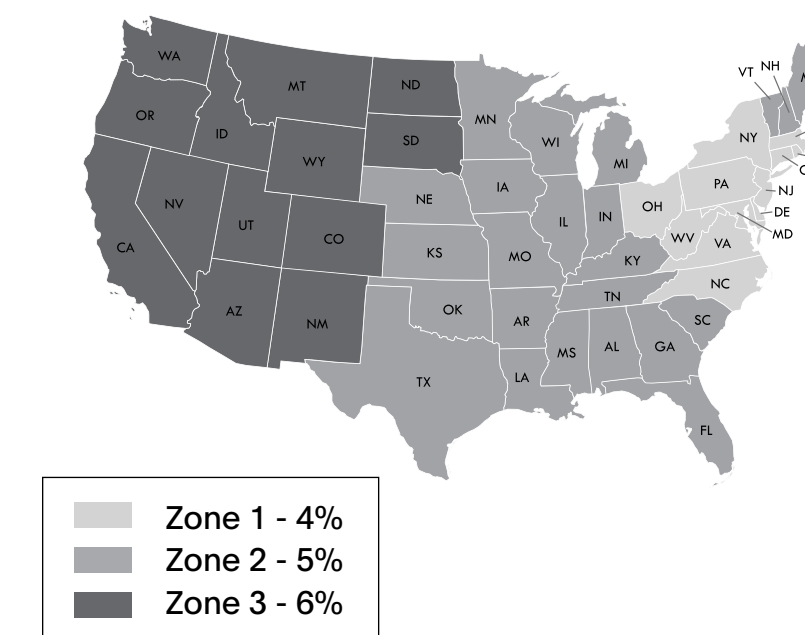

ZONE 1 - 4%

Connecticut
Delaware
New York
New Jersey
Maryland
Massachusetts
North Carolina
Ohio
Pennsylvania
Rhode Island
Virginia
Washington D.C.
West Virginia

ZONE 2 - 5%

Alabama
Arkansas
Canada, Ontario
Canada, Quebec
Florida
Georgia
Iowa
Illinois
Indiana
Kansas
Kentucky
Louisiana
Nebraska
New Hampshire
Oklahoma
Maine
Michigan
Minnesota
Missouri
Mississippi
South Carolina
Tennessee
Texas
Vermont
Wisconsin

ZONE 3 - 6%

Arizona
California
Colorado
Idaho
Montana
Nevada
New Mexico
North Dakota
Oregon
South Dakota
Utah
Washington
Wyoming

Quote Per Project

Alaska
Hawaii
Canada
(outside Ontario & Quebec)
Mexico

General Information

STYLEX PRICE LIST

TEXTILE PARTNERS & APPROVALS

Textile Partners

To customize your furniture performance needs and design vision, Stylex offers a wide selection of in-graded leathers and textiles from Grades A through Y. We've partnered with leading manufacturers on the options, focusing on color, price, durability, and construction. To view our partners and explore our digital carded program with broadly approved textiles, visit [this page](#). We stand by these textiles: They're tried and tested, and will effortlessly fit into any design aesthetic.

Textile Approvals

All textiles must be approved for the product you are specifying. For the related approved textile lists, visit [this page](#).

CAL 117 AND 133 COMPLIANCE

CAL 117-2013

CAL 117-2013 compliance is a requirement for all textiles applied on our seating products. All Stylex seating products meet this standard.

CAL 133

Most Stylex seating can be ordered to meet the requirements of CAL 133. When ordering, simply specify "CAL 133 compliance required". The upcharge for this option is \$54 list per yard. Please refer to the COM yardage of each model to determine the number of yards required. We do frequently require full-scale burn tests in order to certify CAL 133 before an order will be accepted. Such burn tests may increase normal lead times and do carry additional charges. Please contact your Stylex account manager for details.

CUSTOMER'S OWN MATERIAL/LEATHER

Customer's own material (COM) and customer's own leather (COL) will generally be upholstered at the price designated in each product's price list. Please be advised, however, that we specifically reserve the right to charge a higher price when we determine that special circumstances, such as unusual repeats or challenging materials, present themselves. All orders for custom coverings must be approved by Stylex before they will be accepted for production. To submit proposed textile for approval, please use the COM form [here](#).

Special Note:

We assume no responsibility for the durability or tailoring quality of any COM or COL. Directional covers in particular may not meet your satisfaction due to the design of certain products. Please be advised that COM and COL orders are not subject to return. If you have doubts about the ultimate appearance of certain coverings, please order a sample done with that specific COM or COL. In addition, while we inspect fabrics for mill imperfections, some are difficult to recognize. We cannot be responsible for defects, color inaccuracies, dye lot variations, or other flaws.

Under no circumstances will we be responsible for COM shortages, flaws, or other such problems. Finally, it is not our responsibility to police the receipt of COM's in order to meet delivery deadlines, and we assume our customers are aware of any undue delay in the shipment of their COM fabrics.

COM fabric and COL leather should be sent prepaid to: Stylex

**Attn: COM/COL - [Your Stylex PO #]
740 Coopertown Road
Delanco, NJ 08075**

All COM/COL sent to Stylex must be accompanied with a packing list which indicates the dealers' name, Stylex corresponding PO number, sales order number, COM/COL supplier name, textile pattern, colorway and shipped quantity. Stylex requires COM to be sent in as continuous yardage in the same dielot.

Yardage requirements shown in the price list are based on non-directional goods of 54" width. Fabrics less than 54" wide or those requiring matching (stripes, prints, or large patterned designs) call for additional yardage. We will be happy to supply yardage requirements for large quantities where economies may be realized.

Add the following yardage for stripes, plaids, or patterns with repeats:

Fabric Width	Plain Fabric	2-14" Repeat	15-24" Repeat	25-27" Repeat	28-36" Repeat
54"	0%	10%	15%	20%	25%
50"	10%	20%	25%	30%	35%
48"	15%	25%	30%	35%	40%
45"	40%	50%	55%	60%	65%
36"	50%	60%	65%	70%	75%

COM/COL FORM

To avoid delay in processing COM orders we request that you submit a sample of your COM textile stapled to this form which can be downloaded [here](#). If a textile has a stripe or design, the size of the repeat should be indicated. Please indicate the textile supplier's name, textile number, and color. Also indicate the Stylex product on which the textile will be used. If a certain direction of application is required, please ensure that information is communicated directly to your Stylex account manager.

The fabric supplier must indicate on his shipping labels the dealer name and purchase order number as well as the Stylex model number.

Please Note:

No order may be entered into production or have a shipping date assigned until all related COM is received at the factory.



CENTER OF STRIPE OR DESIGN

TOP OF CHAIR	TOP OF CHAIR
--------------	--------------

1. Size of Repeat

2. Textile Supplier

3. Textile Number

4. Color

5. Stylex Product

Free Address

Contents

<hr/>		<hr/>		<hr/>	
COLORS, MATERIALS, AND FINISHES	5	BENCHES	20	TABLE TOPS	43
STATEMENT OF LINE	6	SEATS: 29H	22	CASE GOODS	46
DIMENSIONS	11	SEATS: 36H	26	FRAMES	52
POWER	12	SEATS: 42H	34	TABLES: TABLETS & FREESTANDING	56
HOW TO ORDER	17	ARMS	42	SCREENS	59
<hr/>		<hr/>		<hr/>	

CLICK THE TITLES ABOVE TO NAVIGATE THROUGH THE DOCUMENT
PRODUCT HEADERS ON SUBSEQUENT PAGES LINK BACK TO THIS PAGE

Free Address

COLORS, MATERIALS, AND FINISHES

POWDER COATED METAL

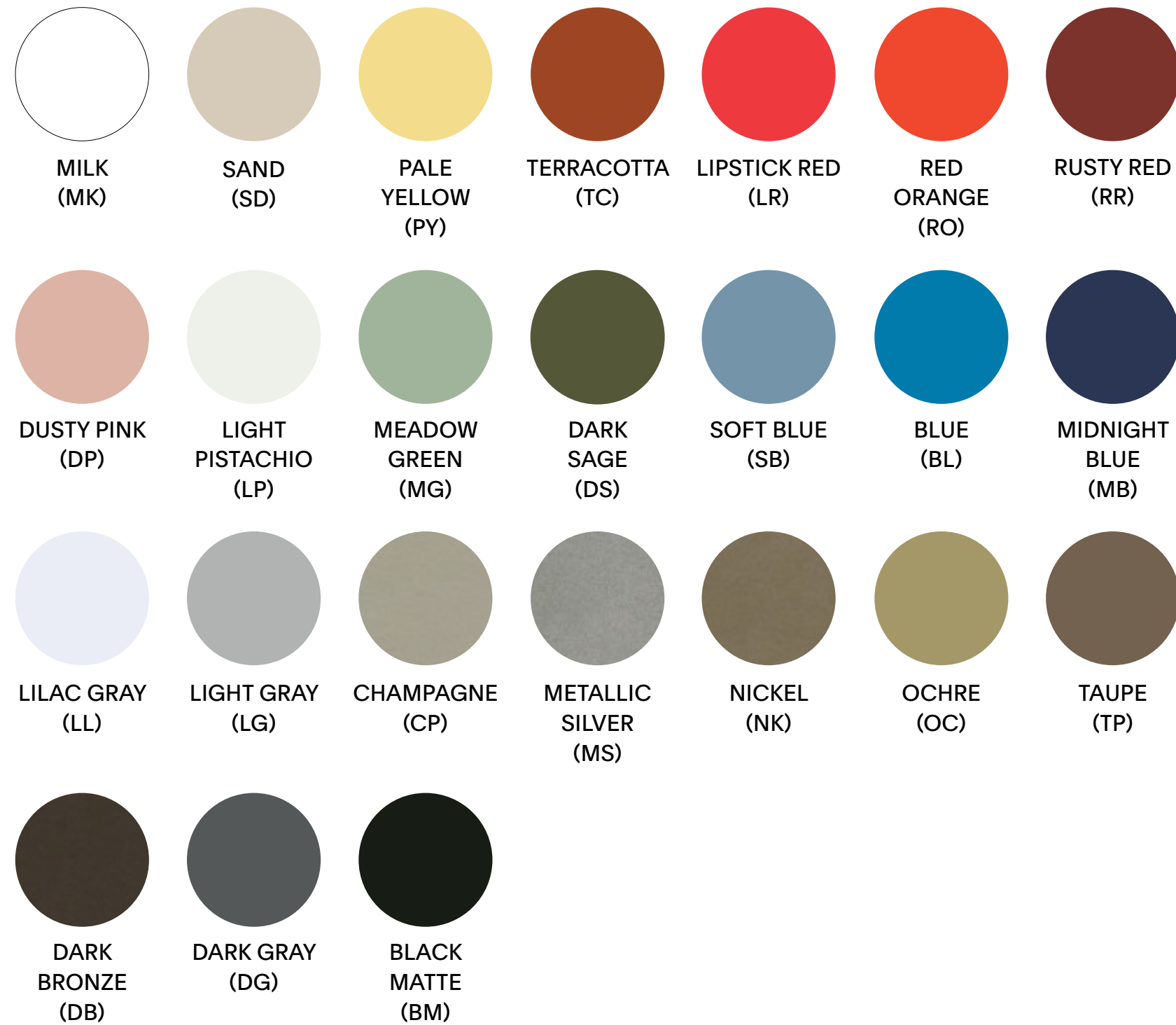

GRADE 1 WILSONART® LAMINATE



WOOD VENEER





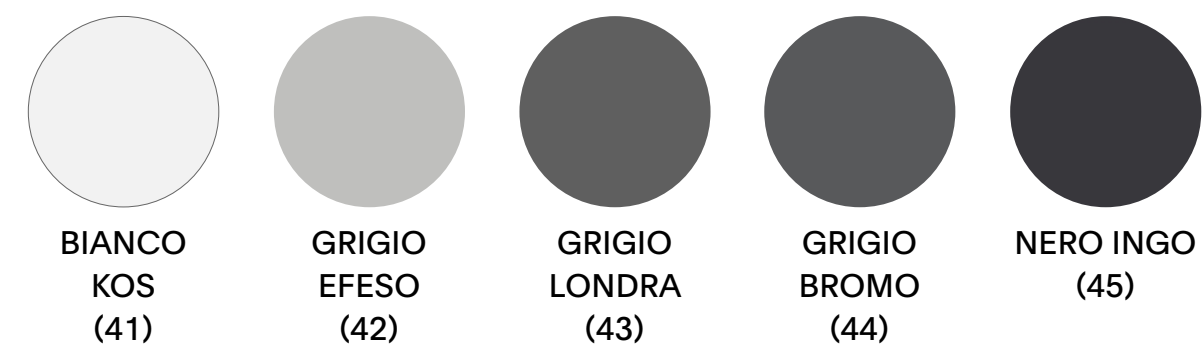



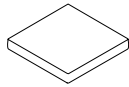
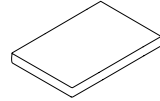
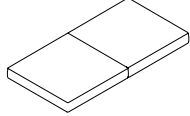
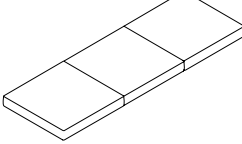
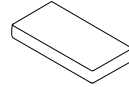
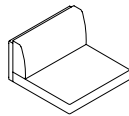
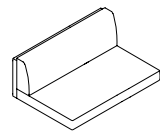
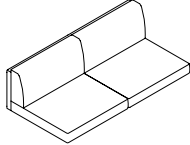
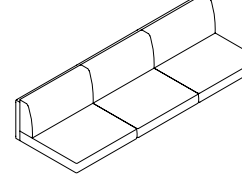
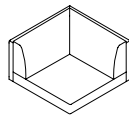
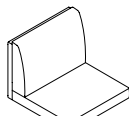
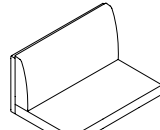
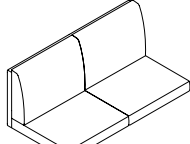
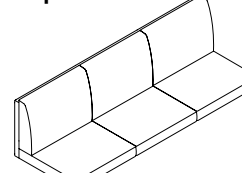
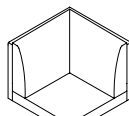
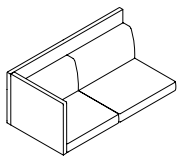
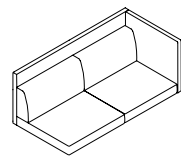
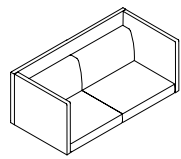

GRADE 2 FENIX® LAMINATE

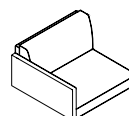
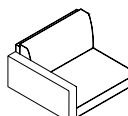
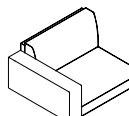
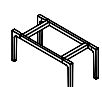
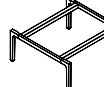
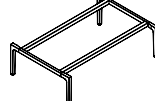
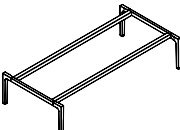
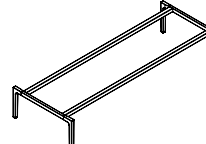
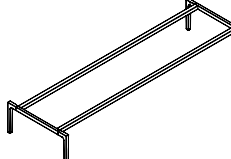

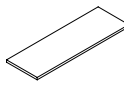
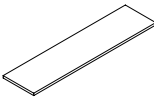
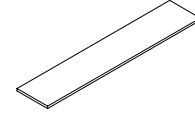
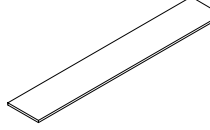
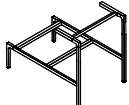
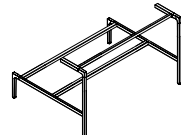
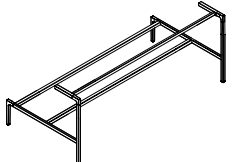
Free Address

SPECIFICATION GUIDE: STATEMENT OF LINE, SEATS AND FRAMES

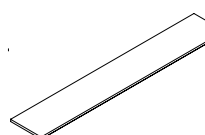
OVERVIEW SEATS							
Benches	Single	Single Plus	Double	Triple	Half		
							
Task Seats 29", 36", 42" Heights	Single	Single Plus	Double	Triple	Corner		
							
Banquette Seats 36", 42" Heights	Single	Single Plus	Double	Triple	Corner		
							
End Panels 29", 36", 42" Heights With Task or Banquette Seats	End Panel Right	End Panel Left	End Panel Both Sides Double/Triple Seat Only	Arms	2" Arm	4" Arm	6" Arm
							
Seat Height Frames 13" High 15", 30", 45" Deep	15" Long	30" Long	45" Long	60" Long	75" Long	90" Long	
							
Seat Height Table Tops 1" Thick 15", 30", 45" Deep	15" Long	30" Long	45" Long	60" Long	75" Long*	90" Long*	*75" and 90" long tops are only available in 15" deep
							
Seat with Ledge Frames 29", 36", 42" High	30" Long	60" Long	90" Long	Ledge Table Tops 1" Thick 15" Deep	30" Long	60" Long	90" Long
							

GENERAL INFORMATION

Design

Stylex / Gensler Product Design Consultant

Frames/Tables/Case Goods

A selection of wood veneer and laminate are available. Effective 5/15/23, lockers, cubbies and shelves in Grade 1 laminate utilize butt-joint construction. Please see [page 10](#) for details.

Configuration

Free Address is a kit of parts comprised of upholstered seating, case goods, and work surfaces offering integrated solutions at 29" task, 36" counter, and 42" bar heights. The customer has freedom to arrange these components on frames in order to prioritize aesthetics, cost and ease of reconfigurability. Users can address a wide variety of workstyles through configuration: short term, long term, individual or collaborative spaces. To ensure clarity when ordering, it is critical that line items should be listed in the order in which they will be arranged from left end (seated perspective) to right end wherever possible. The use of CET Designer is the preferred method for specifying this product.

Glides

Glide height adjustability of seat height frames is 5/8". Glide height adjustability on tables is 1".

Ganging

All frames of the same height may be connected to one another with the use of bent sheet metal ganging brackets.

Use

Designed for indoor use only.

Performance Standards

Manufactured to comply with:
ANSI/BIFMA X5.4 Lounge Seating Tests
ANSI/BIFMA X5.5 Desk & Table Products
ANSI/BIFMA X5.9 Storage Units

Certifications

GREENGUARD Gold - Seating, Laminate Table
GREENGUARD - Privacy Panel, Wood Veneer Table
LEVEL® 2

Free Address

SPECIFICATION GUIDE: STATEMENT OF LINE, CASE GOODS AND TABLET TABLES

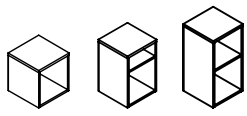
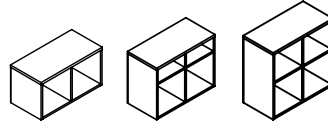
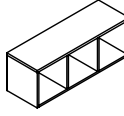
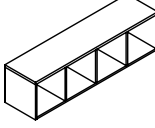
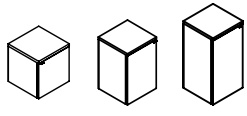
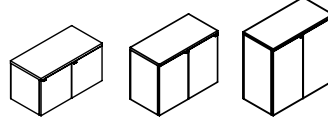
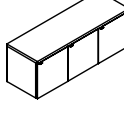
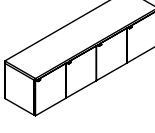
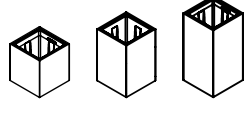
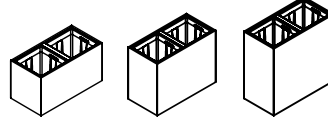
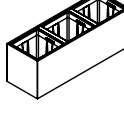
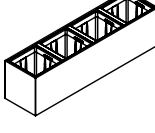
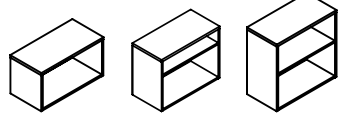
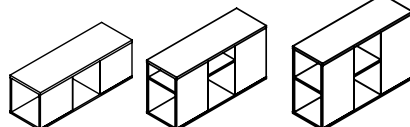
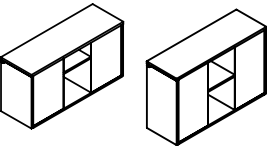
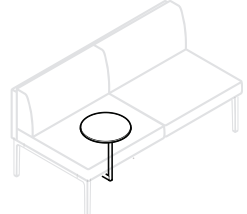
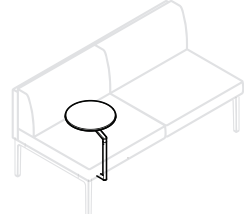
OVERVIEW CASE GOODS	29" Height Only			
Cubby 29", 36", 42" Heights	15" Single 	30" Double 	45" Triple 	60" Quad 
Locker 29", 36", 42" Heights	15" Single 	30" Double 	45" Triple 	60" Quad 
Planter 29", 36", 42" Heights	15" Single 	30" Double 	45" Triple 	60" Quad 
Shelf 29", 36", 42" Heights	30" Double 			
Cubby Combo 29", 36", 42" Heights	45" Triple 			
Locker Combo 29", 36", 42" Heights	45" Triple 			
Tablet Tables	Single Swivel 	Dual Swivel 		

GENERAL INFORMATION

Design

Stylex / Gensler Product Design Consultant

Tables/Case Goods

A selection of wood veneer and laminate are available. Effective 5/15/23, lockers, cubbies and shelves in Grade 1 laminate utilize butt-joint construction. Please see [page 10](#) for details.

Configuration

Free Address is a kit of parts comprised of upholstered seating, case goods, and work surfaces offering integrated solutions at 29" task, 36" counter, and 42" bar heights. The customer has freedom to arrange these components on frames in order to prioritize aesthetics, cost and ease of reconfigurability. Users can address a wide variety of workstyles through configuration: short term, long term, individual or collaborative spaces. To ensure clarity when ordering, it is critical that line items should be listed in the order in which they will be arranged from left end (seated perspective) to right end wherever possible. The use of CET Designer is the preferred method for specifying this product.

Ganging

All frames of the same height may be connected to one another with the use of bent sheet metal ganging brackets.

Tablets

Under mount tablet arms are available in single or dual swivel, with four solid wood finish options. They can be screwed to the underside of Free Address along the front of the unit.

Use

Designed for indoor use only.

Performance Standards





Manufactured to comply with:
 ANSI/BIFMA X5.4 Lounge Seating Tests
 ANSI/BIFMA X5.5 Desk & Table Products
 ANSI/BIFMA X5.9 Storage Units

Certifications

GREENGUARD Gold - Seating, Laminate Table
 GREENGUARD - Case Goods, Privacy Panel, Wood Veneer Table
 LEVEL® 2

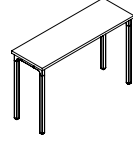
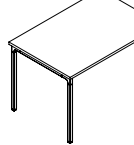
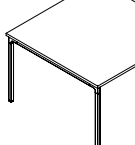
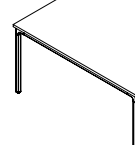
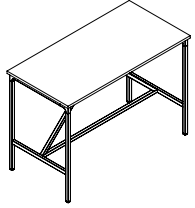
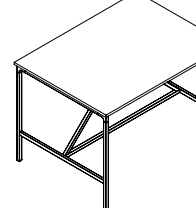
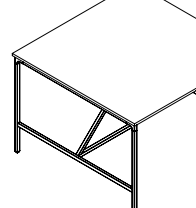
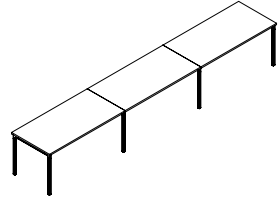
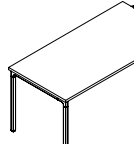
Free Address

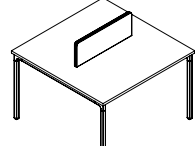
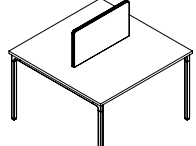
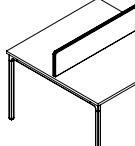
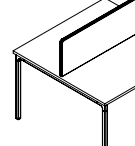
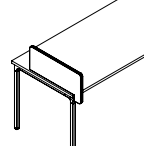
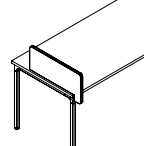
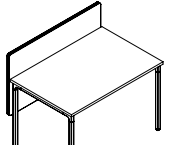
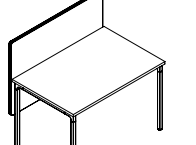
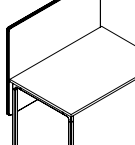
SPECIFICATION GUIDE: STATEMENT OF LINE, TABLES

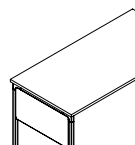
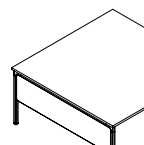
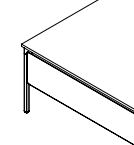
OVERVIEW TABLES							GENERAL INFORMATION	
Tables with Frames 29" Desk Height	15D x 30L	30D x 15L	45D x 15L	60D x 15L				
	15D x 45L	30D x 30L	45D x 30L	60D x 30L				
	15D x 60L	30D x 45L	45D x 45L	60D x 45L				
		30D x 60L	45D x 60L	60D x 60L				
								
High Tables with Frames 36" Counter Height 42" Bar Height	30D x 60L	45D x 60L	60D x 60L					
								
Table Runs 29", 36", 42" Heights	Full Assembly	Start Table	Mid Table	End Table				
								
Privacy - Center For 45", 60" Tables	Low 10" - Partial	Mid 15" - Partial	Low 10" - Full	Mid 15" - Full	Privacy - Side	Low 10"		
								
Privacy - Perimeter For 30", 45", 60" Tables	Low 10"	Mid 15"	High 21"	Modesty End	End of 30" Table	End of 45" Table	End of 60" Table	
								

Design
 Stylex / Gensler Product Design Consultant

Tables/Case Goods
 A selection of wood veneer and laminate are available. Lockers, cubbies and shelves in Grade 1 laminate utilize butt-joint construction. Please see [page 10](#) for details.

Screens
 Free Address offers privacy and modesty screens which are comprised of a tackable substrate. Contact customer service for upholstery options.

Configuration
 Free Address is a kit of parts comprised of upholstered seating, case goods, and work surfaces offering integrated solutions at 29" task, 36" counter, and 42" bar heights. The customer has freedom to arrange these components on frames in order to prioritize aesthetics, cost and ease of reconfigurability. Users can address a wide variety of workstyles through configuration: short term, long term, individual or collaborative spaces. To ensure clarity when ordering, it is critical that line items should be listed in the order in which they will be arranged from left end (seated perspective) to right end wherever possible. The use of CET Designer is the preferred method for specifying this product.

Casters/Glides
 Locking casters are available on tables that are larger than 15" in length and depth. Casters come in black, and are available in both hard and soft options. Casters are not available on tables with power. Glide height adjustability of seat height frames is 5/8". Glide height adjustability on tables is 1".

Ganging
 All frames of the same height may be connected to one another with the use of bent sheet metal ganging brackets.

Use
 Designed for indoor use only.







Performance Standards
 Manufactured to comply with:
 ANSI/BIFMA X5.4 Lounge Seating Tests
 ANSI/BIFMA X5.5 Desk & Table Products
 ANSI/BIFMA X5.9 Storage Units

Certifications
 GREENGUARD Gold - Seating, Laminate Table
 GREENGUARD - Case Goods, Privacy Panel, Wood Veneer Table
 LEVEL® 2

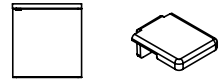
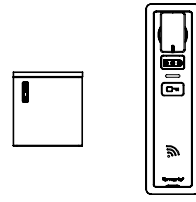
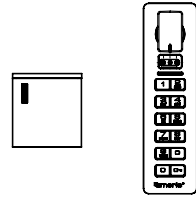
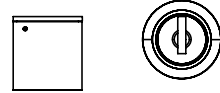
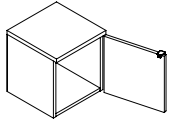
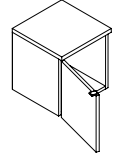
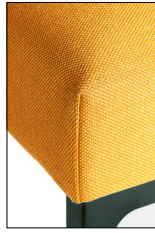
Free Address

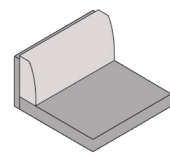
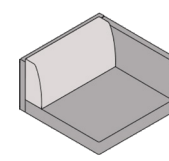
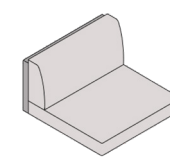
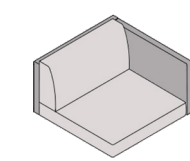
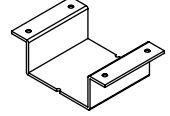
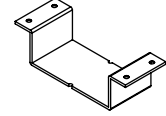
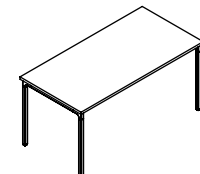
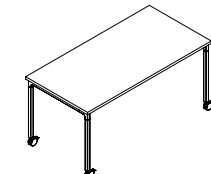
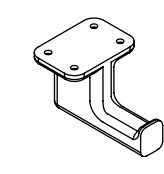
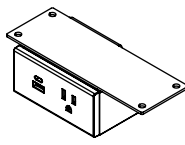
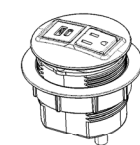
SPECIFICATION GUIDE: STATEMENT OF LINE, OPTIONS AND ACCESSORIES

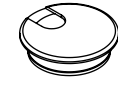
OVERVIEW OPTIONS

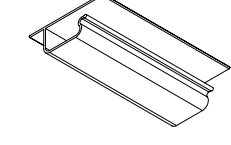
Lock Type	Pull (no lock) 	RFID Lock 	Number Pad Lock 	Key Lock 			
Locker Hinge Side	Right Hinge (default) 	Left Hinge 					
Upholstery Options Seam Style Dual Fabric	Casual 	Pinch 	Standard 	DF1 for No End Panels  Fabric 1: Seat Cushion/Back Panel Fabric 2: Back Cushion	DF1 for End Panels  Fabric 1: Seat Cushion, Back/Side Panel Fabric 2: Back Cushion	DF2 for No End Panels  Fabric 1: Back Panel Fabric 2: Seat/Back Cushion	DF2 for End Panels  Fabric 1: Back/Side Panel Fabric 2: Seat/Back Cushion
Ganging and Frames	FG1 Seat Height Frames 	FG2 Work Height Table Frames 	Table Options and Accessories		Glide 	Caster (Tables Only) 	Bag Hook 
Power Module	Undermount 	Surface Mount 	Wireless Charging Pad 	Wire Management	Grommet 	Wire Snake 	Channel 

For daisy chaining power options, see [page 14](#).

GENERAL INFORMATION

Design

Stylex / Gensler Product Design Consultant

Configuration

Free Address is a kit of parts comprised of upholstered seating, case goods, and work surfaces offering integrated solutions at 29" task, 36" counter, and 42" bar heights. The customer has freedom to arrange these components on frames in order to prioritize aesthetics, cost and ease of reconfigurability. Users can address a wide variety of workstyles through configuration: short term, long term, individual or collaborative spaces. To ensure clarity when ordering, it is critical that line items should be listed in the order in which they will be arranged from left end (seated perspective) to right end wherever possible. The use of CET Designer is the preferred method for specifying this product.

Power

Undermount and Surface mount units can be specified to be hardwired or with a 3-prong plug. The units have one USB-A port, one USB-C port, and a standard, grounded 3-prong electrical outlet. Additional power options include daisy chaining and wireless surface mount charging.

Ganging

All frames of the same height may be connected to one another with the use of bent sheet metal ganging brackets.

Use

Designed for indoor use only.

Performance Standards

Manufactured to comply with:
ANSI/BIFMA X5.4 Lounge Seating Tests
ANSI/BIFMA X5.5 Desk & Table Products
ANSI/BIFMA X5.9 Storage Units

Certifications

GREENGUARD Gold - Seating, Laminate Table
GREENGUARD - Case Goods, Privacy Panel, Wood Veneer Table
LEVEL® 2

Free Address

SPECIFICATION GUIDE: GRADE 1 LAMINATE CONSTRUCTION AND CUSTOM FINISH

OVERVIEW OPTIONS

Grade 1 Laminate Construction

Lockers, cubbies and shelves in Grade 1 laminate utilize butt-joint construction. If the backs of any lockers, cubbies, and shelves will be exposed, we recommend utilizing mitered construction by specifying Grade 2 laminate, wood veneer, or a custom solution.

Top View

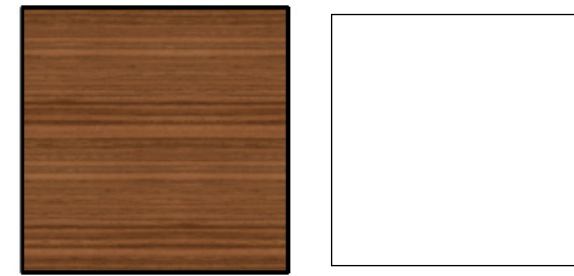

Front View

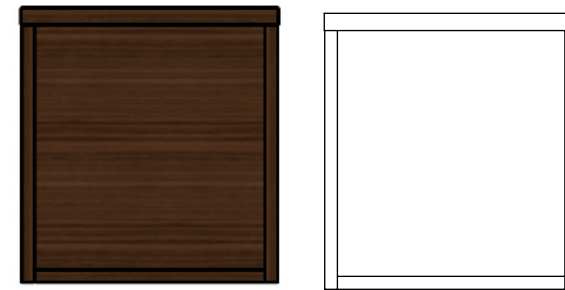

Side View



Rear View

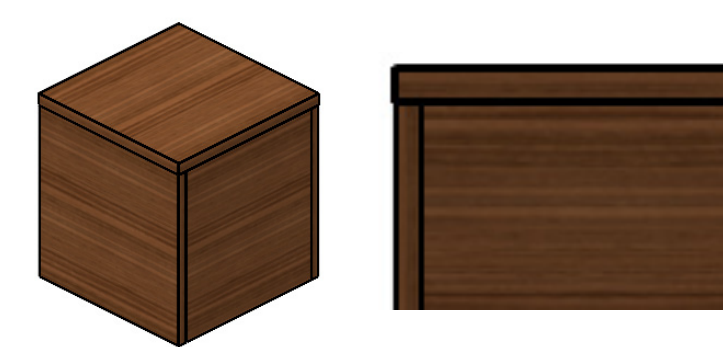
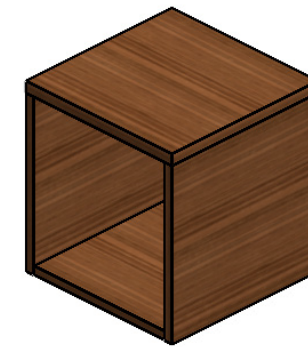

Custom Laminate and Wood Finish

LM99
Custom Laminate

Non-standard laminates will be quoted per color. Please contact Stylex customer service with the manufacturer's name and laminate color reference number.

WV99
Custom Veneer Finish

Two 4"X4" samples are required with, or before, order placement for each custom stain. A custom color match fee of \$554.00 will apply per color. Please contact customer service for details.

GENERAL INFORMATION

Design

Stylex / Gensler Product Design Consultant

Tables/Case Goods

A selection of wood veneer and laminate are available. Lockers, cubbies and shelves in Grade 1 laminate utilize butt-joint construction.

Configuration

Free Address is a kit of parts comprised of upholstered seating, case goods, and work surfaces offering integrated solutions at 29" task, 36" counter, and 42" bar heights. The customer has freedom to arrange these components on frames in order to prioritize aesthetics, cost and ease of reconfigurability. Users can address a wide variety of workstyles through configuration: short term, long term, individual or collaborative spaces. To ensure clarity when ordering, it is critical that line items should be listed in the order in which they will be arranged from left end (seated perspective) to right end wherever possible. The use of CET Designer is the preferred method for specifying this product.

Use

Designed for indoor use only.

Performance Standards

Manufactured to comply with:
ANSI/BIFMA X5.4 Lounge Seating Tests
ANSI/BIFMA X5.5 Desk & Table Products
ANSI/BIFMA X5.9 Storage Units

Certifications

GREENGUARD Gold - Seating, Laminate Table
GREENGUARD - Case Goods, Privacy Panel, Wood Veneer Table
LEVEL® 2

Free Address

SPECIFICATION GUIDE: DIMENSIONS

*Overall height when mounted on a frame.

OVERVIEW

Task Seats With or Without End Panels	Single	Single Plus	Double	Triple	Corner
A. Seat Height	A. 18	A. 18	A. 18	A. 18	A. 18
B. Seat Depth	B. 20.5	B. 20.5	B. 20.5	B. 20.5	B. 20.5
C. Back Height	C. 13.5	C. 13.5	C. 13.5	C. 13.5	C. 13.5
D1. Overall Height (29H)	D1. 30.5	D1. 30.5	D1. 30.5	D1. 30.5	D1. 30.5
D2. Overall Height (36H)	D2. 36.5	D2. 36.5	D2. 36.5	D2. 36.5	D2. 36.5
D3. Overall Height (42H)	D3. 42.5	D3. 42.5	D3. 42.5	D3. 42.5	D3. 42.5
E. Overall Depth	E. 30	E. 30	E. 30	E. 30	E. 30
F. Overall Length	F. 30	F. 30	F. 30	F. 30	F. 30

Banquette Seats With or Without End Panels	Single	Single Plus	Double	Triple	Corner
A. Seat Height	A. 18	A. 18	A. 18	A. 18	A. 18
B. Seat Depth	B. 20.5	B. 20.5	B. 20.5	B. 20.5	B. 20.5
C. Back Height	C. 20.5	C. 13.5	C. 13.5	C. 13.5	C. 13.5
D1. Overall Height (36H)	D1. 37.5	D1. 37.5	D1. 37.5	D1. 37.5	D1. 37.5
D2. Overall Height (42H)	D2. 42.5	D2. 42.5	D2. 42.5	D2. 42.5	D2. 42.5
E. Overall Depth	E. 30	E. 30	E. 30	E. 30	E. 30
F. Overall Length	F. 30	F. 30	F. 30	F. 30	F. 30

Benches	Single	Single Plus	Double	Triple	Half
A. Overall Height	A. 18	A. 18	A. 18	A. 18	A. 18
B. Overall Depth	B. 30	B. 30	B. 30	B. 30	B. 30
C. Overall Length	C. 30	C. 45	C. 60	C. 90	C. 15

Arms	2" Arm	4" Arm	6" Arm
A. Height	A. 26	A. 26	A. 26
B. Depth	B. 30	B. 30	B. 30
C. Length	C. 2	C. 4	C. 6

Seat Height Table Tops	15D	30D	45D
All Table Tops are 1" Thick	15D x 15L	30D x 15L	45D x 15L
Overall Height on Frame is 14"	15D x 30L	30D x 30L	45D x 30L
	15D x 45L	30D x 45L	45D x 45L
	15D x 60L	30D x 60L	45D x 60L
	15D x 75L		
	15D x 90L		

Ledge Height Table Tops	15D
All Table Tops are 1" Thick	15D x 30L
	15D x 60L
	15D x 90L

OVERVIEW

Case Goods	Single	Double	Triple	Quad	Triple Combo
A1. Overall Height (29H)	A1. 29	A1. 29	A1. 29	A1. 29	A1. 29
A2. Overall Height (36H)	A2. 36	A2. 36	A2. 36	A2. 36	A2. 36
A3. Overall Height (42H)	A3. 42	A3. 42	A3. 42	A3. 42	A3. 42
B. Overall Depth	B. 15	B. 15	B. 15	B. 15	B. 15
C. Overall Length	C. 15	C. 30	C. 45	C. 60	C. 45

Planter Liner	A. Interior Height	B. Interior Width (Top)	C. Interior Width (Bottom)
A. Interior Height	A. 11.5		
B. Interior Width (Top)	B. 12.5		
C. Interior Width (Bottom)	C. 11.5		

Seat Height Frames	15D	30D	45D
All Frames are 13" High	15D x 15L	30D x 15L	45D x 15L
Glide Height Adjustability of Seat Height Frames is 5/8"	15D x 30L	30D x 30L	45D x 30L
	15D x 45L	30D x 45L	45D x 45L
	15D x 60L	30D x 60L	45D x 60L
	15D x 75L	30D x 75L	45D x 75L
	15D x 90L	30D x 90L	45D x 90L

Seat with Ledge Frames	30L	60L	90L
Height dimension includes tabletop	29H x 30L	29H x 60L	29H x 90L
	36H x 30L	36H x 60L	36H x 90L
	42H x 30L	42H x 60L	42H x 90L

Tablet Tables	Single/Dual
A. Diameter	A. 14
B. Height Above Seat	B. 9

Freestanding Tables	Desk 29H	Counter 36H	Bar 42H
Glide Height Adjustability of 29H, 36H and 42H Tables is 1"	15D x 30L	30D x 60L	30D x 60L
	15D x 45L	45D x 60L	45D x 60L
	15D x 60L	60D x 60L	60D x 60L
	30D x 15L		
	30D x 30L		
	30D x 45L		
	30D x 60L		
	45D x 15L		
	45D x 30L		
	45D x 45L		
	45D x 60L		

Free Address

SPECIFICATION GUIDE: POWER, UNDER MOUNT

UNDER MOUNT POWER OVERVIEW

**Seating,
Under mount Power**
With or Without
End Panels

Position 2 (Right)

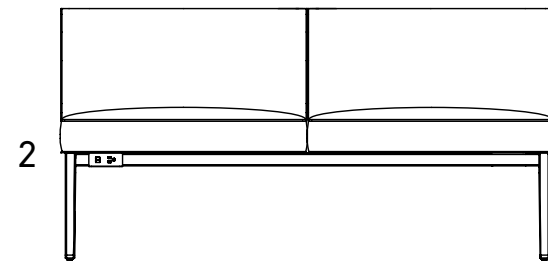

Position 1 and 2 (Left and Right)

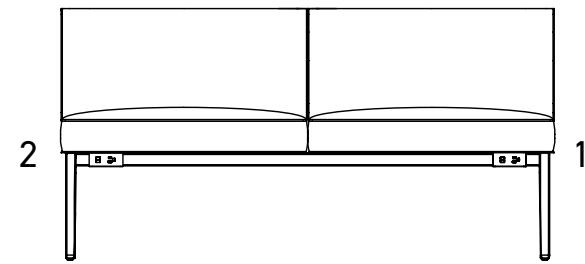

Position 1 (Left)

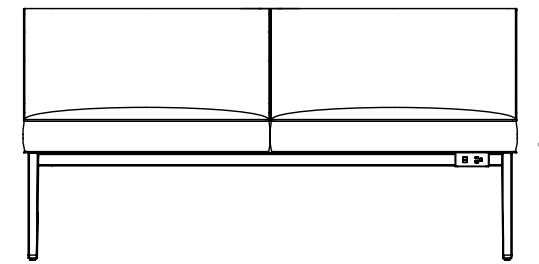

**Ledges,
Under mount Power**

Front View

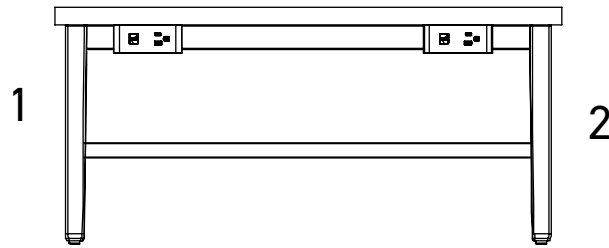

Top View

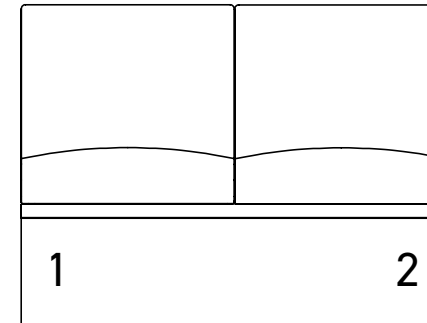

**Tables,
Under mount Power**

Front View

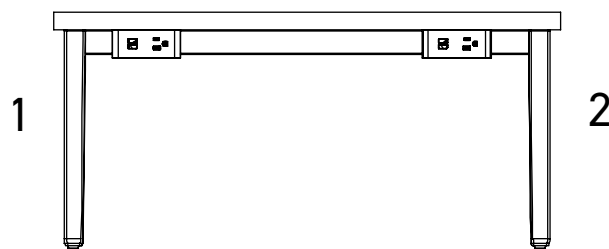

Rear View

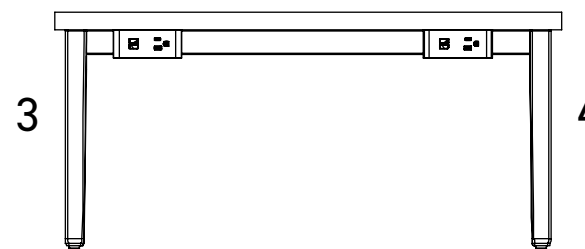

Top View



To Order Select Below

1. Mount Type

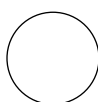

Mount Type

U	UNDERMOUNT
---	------------

2. Color

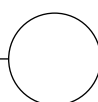

Color

B	BLACK
G	GRAY
W	WHITE

3. Cord

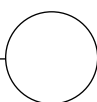

Cord

H	HARDWIRE	+201
---	----------	------

4. Location

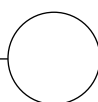

Location

1	POSITION 1 (LEFT)	+648
2	POSITION 2 (RIGHT)	+648

GENERAL INFORMATION

Power

Undermount and Surface mount units can be specified to be hardwired or with a 3-prong plug. The units have one USB-A port, one USB-C port, and a standard, grounded 3-prong electrical outlet. Additional power options include daisy chaining and wireless surface mount charging.

Mounting Options

Under mount power is designated by (U) in the model code.

Cord Length

Both the standard cord and the conduit whip are 10 feet long. Other lengths may be available as a custom order.

Colors

Power units are available in black (B), white (W), and gray (G).

Seat Power Location

Power mounted under seat units is located under the front edge on the left side (position 1), right side (position 2), or both (positions 1 & 2) from a seated perspective.

Example:

UB1 - Under mount, black, position 1

Power is not available on corner seats or arms.

Table Location

Power mounted under tables is located under the front and back edges next to each corner (positions 1 through 4) as shown. Ledge tables only have one exposed long edge and therefore have only positions 1 (left) and 2 (right) available.

Example:

UB1 - Under mount, black, position 1

UG13 - Under mount, gray, positions 1 & 3

Free Address

SPECIFICATION GUIDE: POWER, SURFACE MOUNT

SURFACE MOUNT POWER OVERVIEW

Tables, Power Port Location

29H

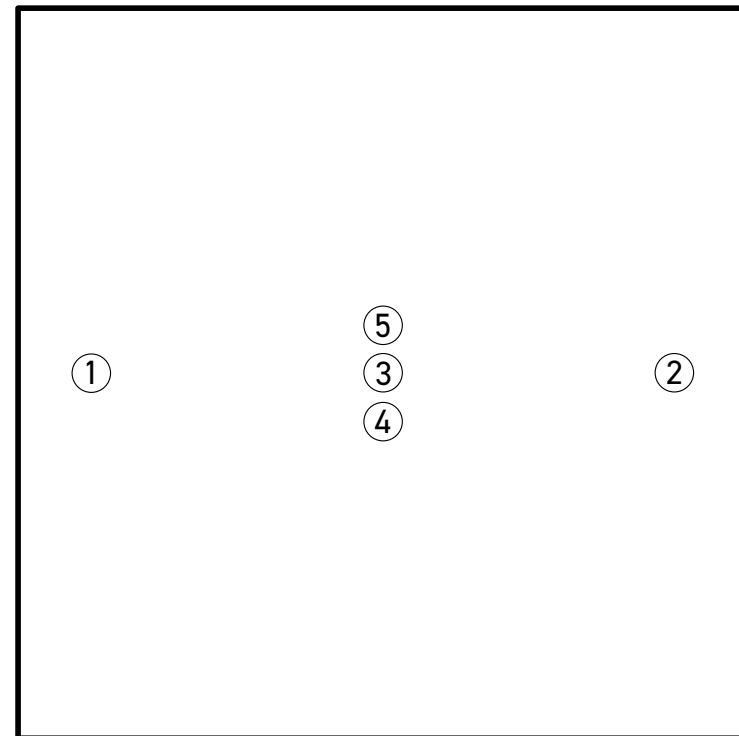

36H and 42H

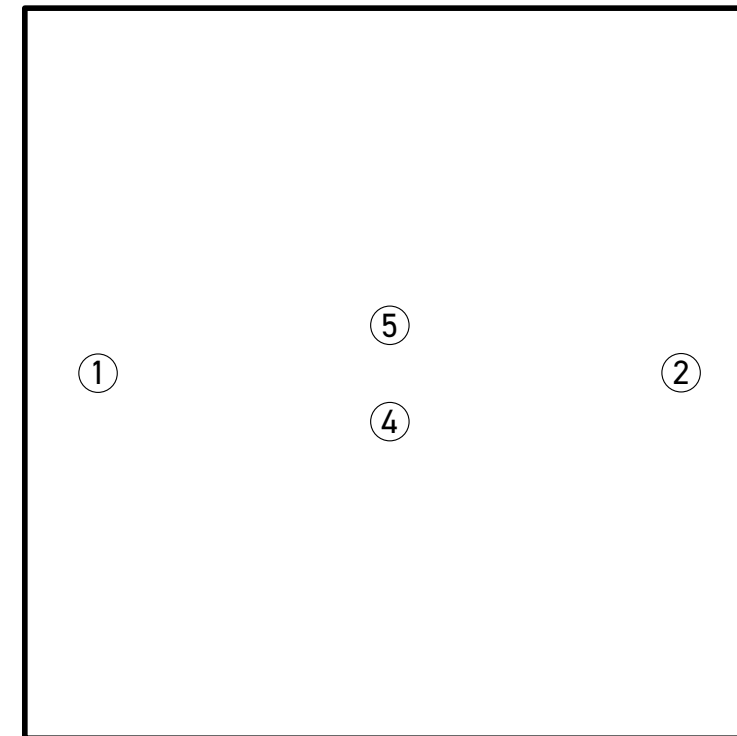

Restrictions

1. Surface power is not available on ledge tops or seat height tops.
2. Position 3 not available when position 4 or 5 is specified.
3. 15" Deep Tables - Surface power not available.
4. 30" Deep Tables - Position 4 and 5 are not available.
5. Full Center Privacy Screen - Positions 1, 2 and 3 are not available.
6. Partial Center Privacy Screen - Position 3 not available.

Cable Management

All units ship with cable mounts and screws included.

GENERAL INFORMATION

Power

Undermount and Surface mount units can be specified to be hardwired or with a 3-prong plug. The units have one USB-A port, one USB-C port, and a standard, grounded 3-prong electrical outlet. Additional power options include daisy chaining and wireless surface mount charging.

Mounting Options

Surface mount power is designated by (S) in the model code.

Cord Length

All power unit cord lengths are 10 feet long. Other lengths may be available as a custom order.

Colors

Power units are available in black (B), white (W), and gray (G).

Location

Surface mount power on tables have 5 possible locations, shown to the left. There are certain location restrictions due to frame and screen configurations.

Example:

SB1 - Surface mount, black, position 1
GTW13 - Grommet, white, positions 1 & 3

To Order Select Below

1. Mount Type

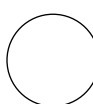

Mount Type

S	SURFACE MOUNT	+573
GT	WIRE GROMMET	+125
WC	WIRELESS CHARGING	+321

2. Color

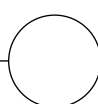

Color

B	BLACK
G	GRAY
W	WHITE

Wireless charging is only available in black.

3. Cord

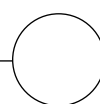

Cord

H	HARDWIRE	+211
---	----------	-------------

Hardwire not available for wireless charging.

4. Location

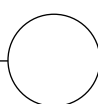

Location

1	POSITION 1 (LEFT)
2	POSITION 2 (RIGHT)
3	POSITION 3 (CENTER)
4	POSITION 4 (CENTER FRONT)
5	POSITION 5 (CENTER BACK)

Free Address

SPECIFICATION GUIDE: POWER, DAISY CHAIN

DAISY CHAIN POWER OVERVIEW

Power Units

Surface Mount

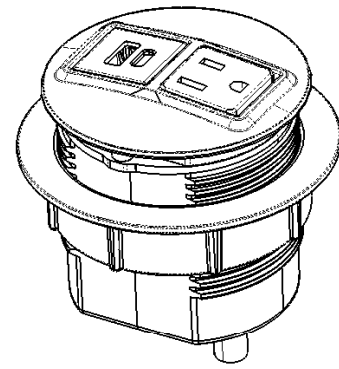

Undermount

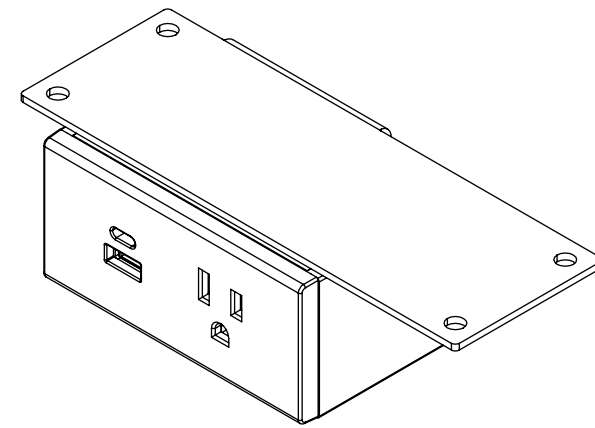

Wireless Charging Pad

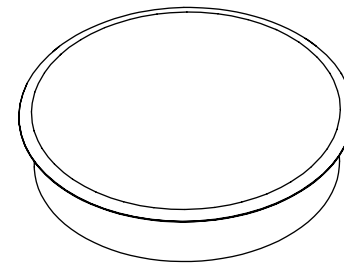

GENERAL INFORMATION

Power

Surface power, undermount power, and wireless charging units can be daisy chained. Up to 8 units can connect to the same system with a single 3-prong plug infeed. Wireless charging pads do not integrate directly into the system and require a Wireless Charging Connector.

Cable Management

All units ship with cable mounts and screws included.

Order Entry

CET is required for order entry. All daisy chain units are entered under 1 line item.

Cable Management

All units ship with cable mounts and screws included.

Use CET to determine jumper lengths and configure daisy chain system.

1. Section



Section

FAPSBS	FREE ADDRESS POWER SYSTEM
--------	---------------------------

2. Options



Options

IF	SYSTEM INFEED (REQUIRED) - UNDER MOUNT	+202
IF	SYSTEM INFEED (REQUIRED) - SURFACE MOUNT	+222
SS	SURFACE POWER	+60
U	UNDERMOUNT POWER	+41
WC1	WIRELESS CHARGING CONNECTOR	+225
	JUMPER EXTENSION (5')	+144

Pricing shown above is in addition to the individual power unit charges on the seat/table line item.

Free Address

SPECIFICATION GUIDE: POWER, WIRE MANAGEMENT

WIRE MANAGEMENT OVERVIEW

Wire Management

Wire Snake

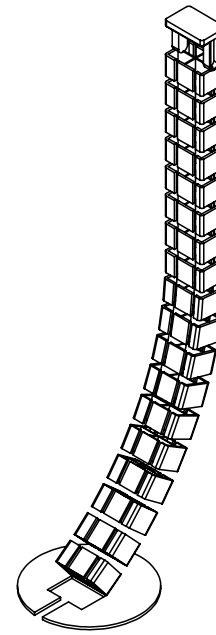

Wire Management Channel

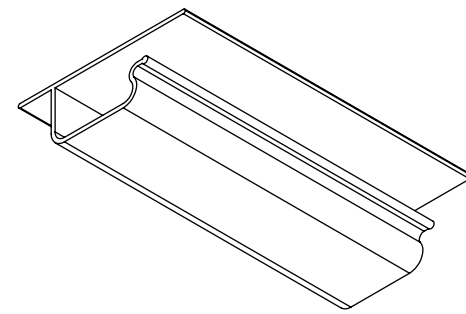

Bag Hook

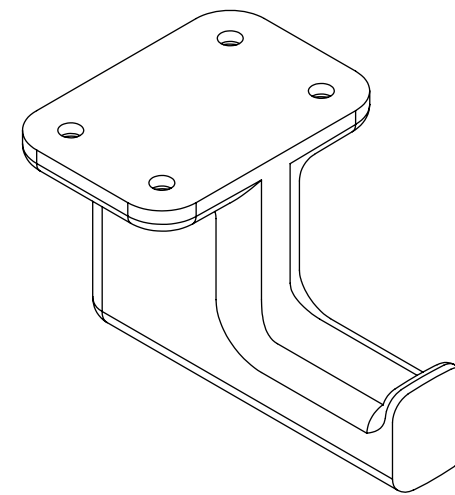

GENERAL INFORMATION

Wire Snake

Flexible vertebrae design with rectangular blocks that snap together, bend and move around. Accommodates 4 different wire channels. A top plate screws to underside of work surface and a heavy steel plate holds the snake in place at the base.

Wire Management Channel

6" long plastic extrusion mounts to underside of units for cable management. Contact Customer Service for more details.

Bag Hook

The bag hook can be powder coated in any of our 26 colors. Weight limit is 35 pounds.

To Order Select Below

1. Section

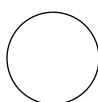

Section

FAW	FREE ADDRESS WIRE MANAGEMENT	
FABK	FREE ADDRESS BAG HOOK	+56

2. Options

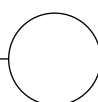

Options

S29	SNAKE, 29"	+524
S36	SNAKE, 36"	+810
S42	SNAKE, 42"	+810
M	CHANNEL (PER SEAT)	+69

Wire snakes are options on work height tables. Wire management channels are options on seating and tables.

Bag hook is its own line item and the others are part for the table line item.

Free Address

SPECIFICATION GUIDE: GANGING AND MASTER KEYS

GANGING AND MASTER KEYS OVERVIEW

Ganging

FAFG1
Seat Height Frame

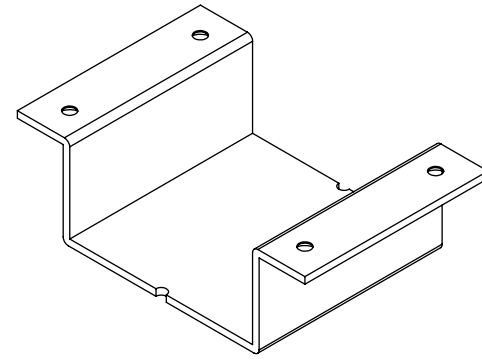

FAFG2
Work Height Table Frame

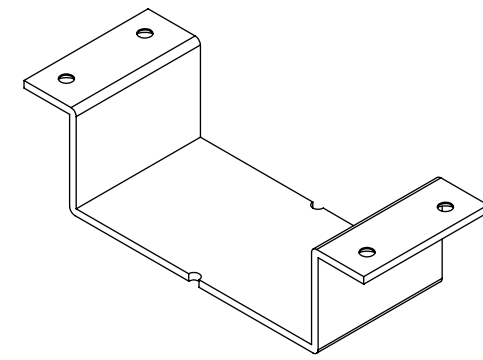

GENERAL INFORMATION

Ganging

Ganging brackets connect frames of identical height. FAFG1 Brackets gang seat height frames together*. FAFG2 Brackets gang work height tables together. Bracket location and quantities must be verified by Stylex or CET Designer.

*Ganging on the ends of 15" deep seat height frames are an exception and require FAFG2 brackets.

Master Key Sets

Each order that contains lockers with locks requires 1 master key set. Additional master keys may be purchased upon request. The RFID and Number pad locks require the digital master key set. The key locks require the key lock master key.

Master Keys

Contact Customer Service for information.

To Order Select Below

1. Section

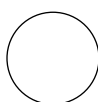

Section

FAFG1	FREE ADDRESS GANGING BRACKET 1	+59
FAFG2	FREE ADDRESS GANGING BRACKET 2	+59
FADK	FREE ADDRESS DIGITAL MASTER KEY SET	+410
FAMK	FREE ADDRESS KEY LOCK MASTER KEY	+47

Free Address

SPECIFICATION GUIDE: HOW TO ORDER, SEATING

MODEL CODE BREAKDOWN - SEATING

Sample Model Code: FA22SBQE36BDF1UB1COM

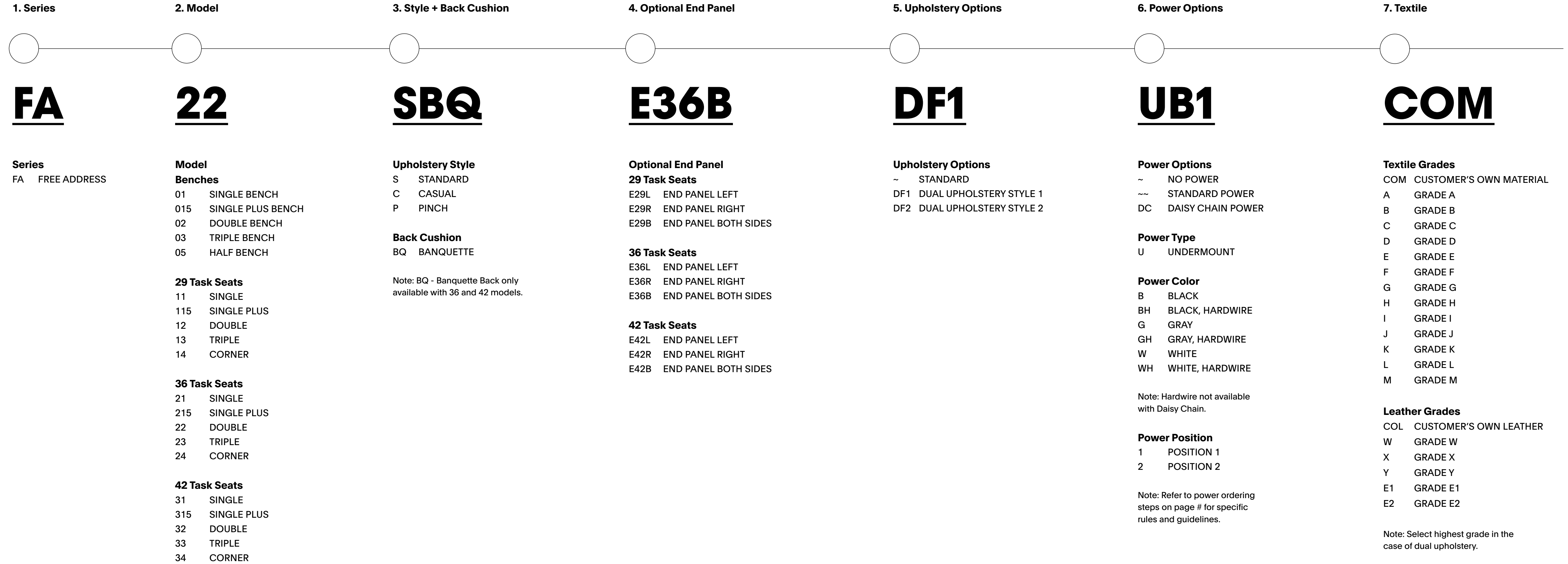

Free Address

SPECIFICATION GUIDE: HOW TO ORDER, CASE GOODS

MODEL CODE BREAKDOWN - CASE GOODS

Sample Model Code: FA6L1H36LM01KBLFB



FA

6L1

H36

LM01

KBL

FB

Series

FA FREE ADDRESS

Model

Locker

6L1 SINGLE
6L2 DOUBLE
6L3 TRIPLE
6L4 QUAD

Cubby

6C1 SINGLE
6C2 DOUBLE
6C3 TRIPLE
6C4 QUAD

Combo Units

6CX CUBBY COMBO
6LX LOCKER COMBO

Planter

6P1 SINGLE
6P2 DOUBLE
6P3 TRIPLE
6P4 QUAD

Shelving

6S SHELF

Height

H29 29"H
H36 36"H
H42 42"H

Note: Heights limited to specific model sizes.

Finish

Laminate Grade 1

LM01 DESIGNER WHITE
LM02 ALABASTER
LM03 WALLABY
LM04 SHADOW
LM05 DOVE GRAY
LM06 FASHION GRAY
LM07 SLATE GRAY
LM08 NORTH SEA
LM09 BLACK
LM10 FUSION MAPLE
LM11 MONTICELLO MAPLE
LM12 RIVER CHERRY
LM13 AMBER CHERRY
LM14 WALNUT HEIGHTS
LM15 MONTANA WALNUT
LM16 XANADU
LM17 ASIAN NIGHT
LM18 CASTLE OAK

Laminate Grade 2

LM41 BIANCO KOS
LM42 GRIGIO EFESO
LM43 GRIGIO LONDRA
LM44 GRIGIO BROMO
LM45 NERO INGO

Custom Laminate

LM99 CUSTOM

Finish

Wood Veneer

WV01 LIGHT GRAY
WV02 WARM GRAY
WV03 OPAQUE BLACK
WV04 MEDIUM CHERRY
WV05 TONED ASH
WV06 NATURAL MAPLE
WV41 TONED RECON WALNUT
WV42 DARK TONED OAK
WV43 TONED WENGE
WV44 TONED OAK
WV45 TONED RECON OAK
WV46 NATURAL FLAT CUT WALNUT
WV47 NATURAL RIFT CUT WALNUT
WV48 NATURAL WHITE OAK
WV49 NATURAL RECON WHITE OAK

Custom Wood Veneer

WV99 CUSTOM

5. Locker Options

Locker Options

Lock Options

P DOOR PULL
KLB KEY LOCK BLACK
KLW KEY LOCK WHITE
NPB NUMBER PAD LOCK BLACK
NPN NUMBER PAD LOCK NICKEL
RFB RFID LOCK BLACK
RFN RFID LOCK NICKEL

Hinge Side

~ HINGE RIGHT WHEN FACING
HG HINGE LEFT WHEN FACING

6. Grain Direction

Grain Direction

~ LEFT/RIGHT
FB FRONT/BACK

Free Address

SPECIFICATION GUIDE: HOW TO ORDER, FRAMES

MODEL CODE BREAKDOWN - FRAMES

Sample Model Code: FA8SD30L45CGS1BL

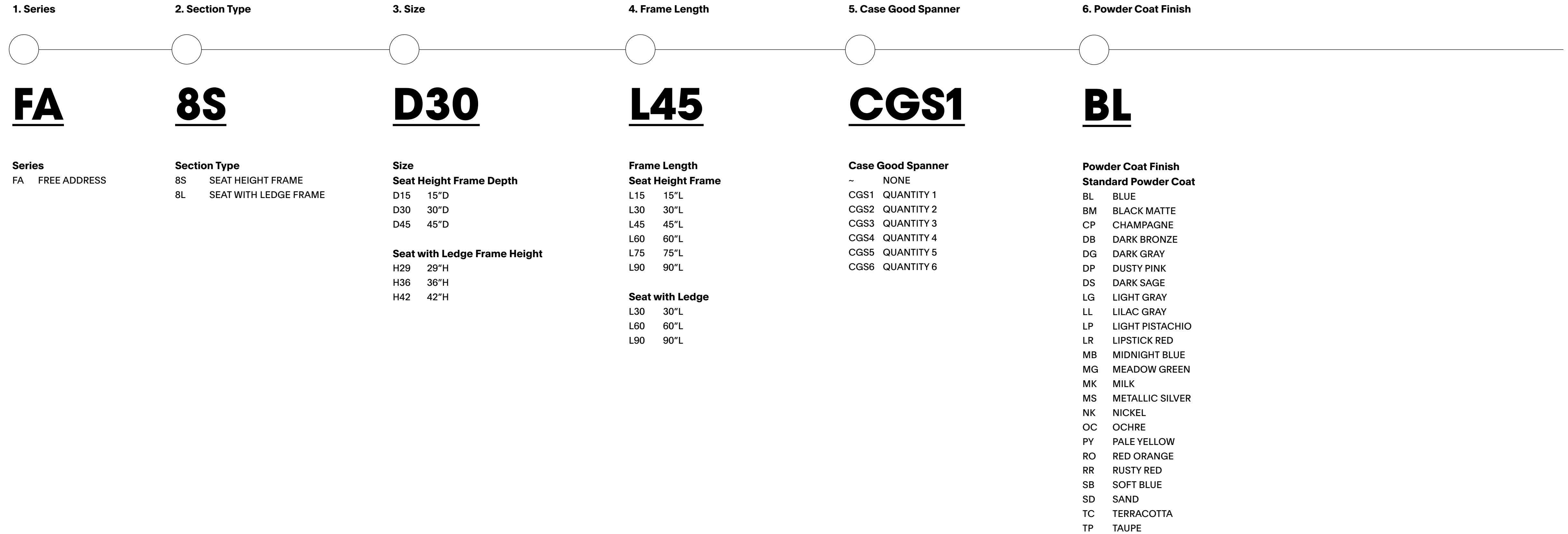

Free Address

BENCHES: TASK BENCH

Textile Upholstery Grades

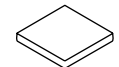
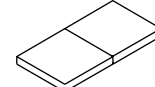
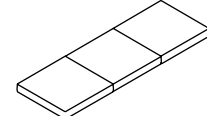
TITLE		SERIES	MODEL	SEAM	PANELS	DIMENSIONS	YDG	COM	A	B	C	D	E	F	G	H	I	J	K	L	M	
Bench, Single		Casual Seam	FA	01	C	-	30W x 30D x 18H	1.7	869	991	1,060	1,123	1,193	1,259	1,332	1,405	1,492	1,604	1,739	1,872	2,006	2,139
		Pinch Seam	FA	01	P	-	30W x 30D x 18H	2.2	894	1,058	1,148	1,236	1,325	1,415	1,512	1,610	1,726	1,874	2,054	2,231	2,411	2,589
		Standard Seam	FA	01	S	-	30W x 30D x 18H	2.2	889	1,052	1,143	1,229	1,320	1,410	1,507	1,606	1,721	1,870	2,049	2,226	2,406	2,582
Bench, Double		Casual Seam	FA	02	C	-	60W x 30D x 18H	3.3	1,516	1,763	1,897	2,028	2,162	2,297	2,444	2,591	2,765	2,987	3,256	3,521	3,791	4,057
		Pinch Seam	FA	02	P	-	60W x 30D x 18H	3.3	1,567	1,814	1,948	2,079	2,213	2,348	2,495	2,642	2,816	3,038	3,306	3,573	3,843	4,108
		Standard Seam	FA	02	S	-	60W x 30D x 18H	3.3	1,557	1,803	1,938	2,069	2,203	2,338	2,486	2,630	2,805	3,027	3,298	3,563	3,831	4,098
Bench, Triple		Casual Seam	FA	03	C	-	90W x 30D x 18H	4.4	2,208	2,534	2,714	2,888	3,069	3,248	3,444	3,640	3,872	4,168	4,526	4,880	5,240	5,593
		Pinch Seam	FA	03	P	-	90W x 30D x 18H	4.4	2,283	2,610	2,789	2,964	3,144	3,323	3,519	3,714	3,948	4,242	4,602	4,956	5,315	5,670
		Standard Seam	FA	03	S	-	90W x 30D x 18H	4.4	2,267	2,595	2,774	2,948	3,127	3,306	3,503	3,698	3,931	4,228	4,586	4,940	5,299	5,654

To Order Select Below

1. Series/Model

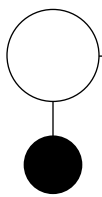

FA01

**Free Address
Bench, Single**

FA02

**Free Address
Bench, Double**

FA03

**Free Address
Bench, Triple**

2. Upholstery Style

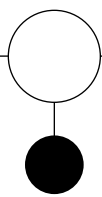

Upholstery Style

C CASUAL

P PINCH

S STANDARD

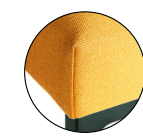

Casual

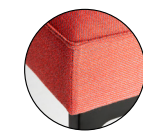

Pinch

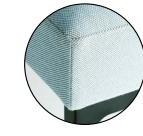

Standard

3. Power

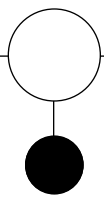

Power

Refer to under mount
power ordering steps
on [page 12](#).

4. Upholstery

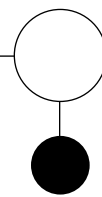

Upholstery

See [general information section](#) for details on textile program and COM/COL information.

Yardages provided are for fabrics cut railroaded. While that is generally our preference for Free Address, there may be exceptions if we decide that up the roll is more visually pleasing. If COM fabrics are to be cut up the roll, please contact customer service. Select highest grade in the case of dual upholstery.

Free Address

BENCHES: TASK BENCH

Textile Upholstery Grades

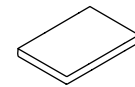
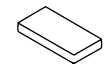
TITLE		SERIES	MODEL	SEAM	PANELS	DIMENSIONS	YDG	COM	A	B	C	D	E	F	G	H	I	J	K	L	M	
Bench, Single Plus		Casual Seam	FA	015	C	-	45W x 30D x 18H	1.9	1,267	1,411	1,488	1,565	1,644	1,722	1,809	1,893	1,994	2,124	2,283	2,437	2,594	2,748
		Pinch Seam	FA	015	P	-	45W x 30D x 18H	2.5	1,374	1,558	1,660	1,757	1,858	1,959	2,069	2,180	2,311	2,476	2,679	2,878	3,079	3,278
		Standard Seam	FA	015	S	-	45W x 30D x 18H	2.5	1,374	1,558	1,660	1,757	1,858	1,959	2,069	2,180	2,311	2,476	2,679	2,878	3,079	3,278
Bench, Half		Casual Seam	FA	05	C	-	15W x 30D x 18H	1.1	609	693	737	781	826	870	919	968	1,026	1,100	1,191	1,279	1,369	1,457
		Pinch Seam	FA	05	P	-	15W x 30D x 18H	1.1	625	706	751	795	839	885	934	983	1,042	1,115	1,204	1,293	1,383	1,472
		Standard Seam	FA	05	S	-	15W x 30D x 18H	1.1	619	702	747	790	835	880	929	978	1,035	1,110	1,199	1,288	1,377	1,465

To Order Select Below

1. Series/Model

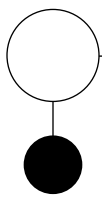

FA015

**Free Address
Bench, Single Plus**

FA05

**Free Address
Bench, Half**

2. Upholstery Style

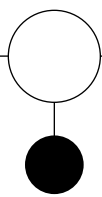

Upholstery Style

C CASUAL

P PINCH

S STANDARD

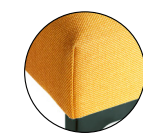

Casual

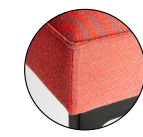

Pinch

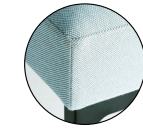

Standard

3. Power

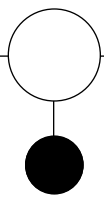

Power

Refer to under mount
power ordering steps
on [page 12](#).

4. Upholstery

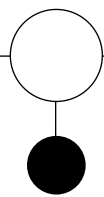

Upholstery

See [general information section](#) for details on textile program and COM/COL information.

Yardages provided are for fabrics cut railroaded. While that is generally our preference for Free Address, there may be exceptions if we decide that up the roll is more visually pleasing. If COM fabrics are to be cut up the roll, please contact customer service. Select highest grade in the case of dual upholstery.

Free Address

SEATS: 29H TASK

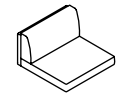
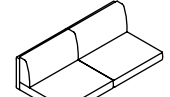

*Height when mounted on a frame.

Textile Upholstery Grades



TITLE		SERIES	MODEL	SEAM	PANELS	DIMENSIONS	YDG	COM	A	B	C	D	E	F	G	H	I	J	K	L	M	
Seat, 29H, Single		Casual Seam	FA	11	C	-	30W x 30D x 30.5H	2.8	1,913	2,117	2,229	2,338	2,449	2,563	2,684	2,807	2,952	3,138	3,361	3,583	3,806	4,028
		Pinch Seam	FA	11	P	-	30W x 30D x 30.5H	2.8	1,947	2,152	2,265	2,373	2,486	2,597	2,720	2,842	2,988	3,172	3,397	3,618	3,843	4,064
		Standard Seam	FA	11	S	-	30W x 30D x 30.5H	2.8	1,942	2,147	2,258	2,368	2,480	2,593	2,714	2,836	2,982	3,167	3,391	3,612	3,838	4,058
Seat, 29H, Single Plus		Casual Seam	FA	115	C	-	45W x 30D x 30.5H	3.3	2,383	2,628	2,763	2,894	3,028	3,164	3,311	3,456	3,631	3,852	4,124	4,389	4,657	4,922
		Pinch Seam	FA	115	P	-	45W x 30D x 30.5H	3.3	2,476	2,723	2,858	2,988	3,123	3,257	3,404	3,552	3,725	3,948	4,216	4,481	4,752	5,017
		Standard Seam	FA	115	S	-	45W x 30D x 30.5H	3	2,476	2,702	2,826	2,945	3,069	3,193	3,327	3,462	3,621	3,824	4,071	4,315	4,561	4,805
Seat, 29H, Double		Casual Seam	FA	12	C	-	60W x 30D x 30.5H	5	3,311	3,678	3,881	4,078	4,279	4,481	4,701	4,921	5,182	5,516	5,920	6,318	6,723	7,120
		Pinch Seam	FA	12	P	-	60W x 30D x 30.5H	5	3,381	3,750	3,952	4,148	4,350	4,552	4,774	4,993	5,254	5,587	5,990	6,389	6,793	7,192
		Standard Seam	FA	12	S	-	60W x 30D x 30.5H	5	3,371	3,740	3,941	4,137	4,340	4,542	4,762	4,982	5,244	5,575	5,981	6,378	6,783	7,181
Seat, 29H, Triple		Casual Seam	FA	13	C	-	90W x 30D x 30.5H	7.2	4,543	5,074	5,367	5,650	5,942	6,234	6,551	6,870	7,248	7,728	8,313	8,887	9,470	10,045
		Pinch Seam	FA	13	P	-	90W x 30D x 30.5H	7.2	4,648	5,180	5,472	5,755	6,048	6,339	6,658	6,974	7,353	7,833	8,417	8,993	9,577	10,152
		Standard Seam	FA	13	S	-	90W x 30D x 30.5H	6.6	4,632	5,124	5,393	5,656	5,924	6,194	6,486	6,780	7,129	7,573	8,111	8,642	9,181	9,713

To Order Select Below

1. Series/Model

	
FA11	Free Address Seat, 29H, Single
FA115	Free Address Seat, 29H, Single Plus
FA12	Free Address Seat, 29H, Double
FA13	Free Address Seat, 29H, Triple

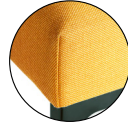
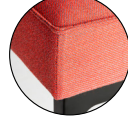

2. Upholstery Style

	Upholstery Style
C	CASUAL
P	PINCH
S	STANDARD
	Casual
	Pinch
	Standard

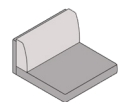
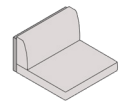

3. Dual Upholstery

	Dual Upholstery	29H Single	29H Single Plus	29H Double	29H Triple
DF1	DUAL UPHOLSTERY STYLE 1	C P S	C P S	C P S	C P S
	Seat Cushion and Back Panel Back Cushion	2.8 yds 2.2 2.2 1.1 yds 1.7 1.1	3.3 3.0 3.0 1.7 1.7 1.7	3.9 3.3 3.3 1.7 2.2 1.7	6.1 5.0 5.0 2.8 3.3 2.8
DF2	DUAL UPHOLSTERY STYLE 2	C P S	C P S	C P S	C P S
	Back Panel Seat and Back Cushions	1.1 yds 1.1 1.1 2.8 yds 2.2 2.2	1.7 1.7 1.7 3.3 3.0 3.0	1.7 1.7 1.7 3.9 4.4 3.9	2.2 2.2 2.2 6.1 6.1 5.5

4. Power

	Power
	Refer to under mount power ordering steps on page 12.

5. Upholstery

	Upholstery
	See general information section for details on textile program and COM/COL information.
	Yardages provided are for fabrics cut railroaded. While that is generally our preference for Free Address, there may be exceptions if we decide that up the roll is more visually pleasing. If COM fabrics are to be cut up the roll, please contact customer service. Select highest grade in the case of dual upholstery.

Free Address

SEATS: 29H TASK CORNER

*Height when mounted on a frame.

Textile Upholstery Grades

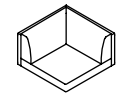
TITLE		SERIES	MODEL	SEAM	PANELS	DIMENSIONS	YDG	COM	A	B	C	D	E	F	G	H	I	J	K	L	M	
Seat, 29H, Corner		Casual Seam	FA	14	C	-	30W x 30D x 30.5H	3.3	2,630	2,877	3,012	3,142	3,277	3,411	3,558	3,706	3,879	4,102	4,370	4,635	4,907	5,172
		Pinch Seam	FA	14	P	-	30W x 30D x 30.5H	3.3	2,680	2,926	3,061	3,191	3,326	3,460	3,608	3,754	3,928	4,151	4,420	4,686	4,955	5,220
		Standard Seam	FA	14	S	-	30W x 30D x 30.5H	3.3	2,678	2,923	3,058	3,189	3,323	3,458	3,604	3,751	3,926	4,148	4,417	4,682	4,952	5,218

To Order Select Below

1. Series/Model

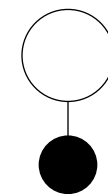

FA14

**Free Address
Seat, 29H, Corner**

2. Upholstery Style

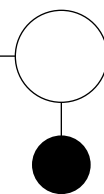

Upholstery Style

C CASUAL

P PINCH

S STANDARD

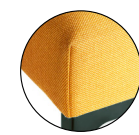

Casual

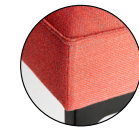

Pinch

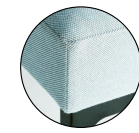

Standard

3. Dual Upholstery

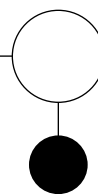

Dual Upholstery

DF1 DUAL UPHOLSTERY STYLE 1

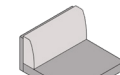
 Seat Cushion and Back Panel
Back Cushion

DF2 DUAL UPHOLSTERY STYLE 2

 Back Panel
Seat and Back Cushions

29H Corner

C P S

2.2 yds 2.2 2.2
1.7 yds 2.2 1.7

C P S

1.7 yds 1.7 1.7
5.0 yds 3.3 2.2

4. Upholstery

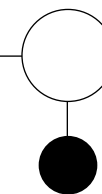

Upholstery

See general information section for details on textile program and COM/COL information.

Yardages provided are for fabrics cut railroaded. While that is generally our preference for Free Address, there may be exceptions if we decide that up the roll is more visually pleasing. If COM fabrics are to be cut up the roll, please contact customer service. Select highest grade in the case of dual upholstery.

Free Address

SEATS: 29H TASK, END PANEL LEFT/RIGHT

*Height when mounted on a frame.

Textile Upholstery Grades

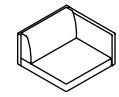
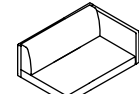
TITLE	SERIES	MODEL	SEAM	PANELS	DIMENSIONS	YDG	COM	A	B	C	D	E	F	G	H	I	J	K	L	M	
Seat, 29H, Single End Panel Left or Right 	Casual Seam	FA	11	C	E29L/R	30W x 30D x 30.5H	3.9	2,302	2,590	2,746	2,900	3,056	3,213	3,384	3,555	3,759	4,016	4,332	4,643	4,956	5,266
	Pinch Seam	FA	11	P	E29L/R	30W x 30D x 30.5H	3.9	2,336	2,623	2,781	2,933	3,091	3,248	3,420	3,590	3,793	4,053	4,366	4,676	4,989	5,301
	Standard Seam	FA	11	S	E29L/R	30W x 30D x 30.5H	3.3	2,333	2,578	2,712	2,843	2,979	3,114	3,259	3,406	3,581	3,802	4,072	4,338	4,608	4,873
Seat, 29H, Single Plus End Panel Left or Right 	Casual Seam	FA	115	C	E29L/R	45W x 30D x 30.5H	4.1	2,875	3,182	3,349	3,513	3,683	3,850	4,034	4,216	4,435	4,712	5,048	5,380	5,718	6,049
	Pinch Seam	FA	115	P	E29L/R	45W x 30D x 30.5H	4.1	2,968	3,275	3,444	3,607	3,775	3,945	4,127	4,310	4,528	4,806	5,142	5,475	5,810	6,143
	Standard Seam	FA	115	S	E29L/R	45W x 30D x 30.5H	3.3	2,968	3,214	3,348	3,479	3,613	3,749	3,895	4,041	4,216	4,438	4,708	4,973	5,243	5,508
Seat, 29H, Double End Panel Left or Right 	Casual Seam	FA	12	C	E29L/R	60W x 30D x 30.5H	6.1	3,700	4,152	4,398	4,638	4,885	5,132	5,401	5,671	5,989	6,397	6,889	7,377	7,871	8,358
	Pinch Seam	FA	12	P	E29L/R	60W x 30D x 30.5H	5.5	3,772	4,181	4,405	4,624	4,847	5,072	5,316	5,561	5,852	6,221	6,670	7,113	7,562	8,005
	Standard Seam	FA	12	S	E29L/R	60W x 30D x 30.5H	5.5	3,761	4,170	4,394	4,612	4,836	5,062	5,306	5,549	5,841	6,210	6,660	7,102	7,551	7,993
Seat, 29H, Triple End Panel Left or Right 	Casual Seam	FA	13	C	E29L/R	90W x 30D x 30.5H	8.3	4,933	5,546	5,882	6,210	6,547	6,884	7,251	7,617	8,053	8,607	9,282	9,944	10,618	11,282
	Pinch Seam	FA	13	P	E29L/R	90W x 30D x 30.5H	7.7	5,039	5,612	5,925	6,231	6,546	6,859	7,201	7,543	7,950	8,468	9,097	9,717	10,346	10,965
	Standard Seam	FA	13	S	E29L/R	90W x 30D x 30.5H	7.7	5,023	5,596	5,911	6,217	6,530	6,844	7,187	7,530	7,935	8,453	9,082	9,701	10,331	10,950

To Order Select Below

1. Series/Model

FA11	Free Address Seat, 29H, Single
FA115	Free Address Seat, 29H, Single Plus
FA12	Free Address Seat, 29H, Double
FA13	Free Address Seat, 29H, Triple

2. Upholstery Style

C	CASUAL
P	PINCH
S	STANDARD

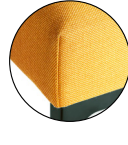

Casual

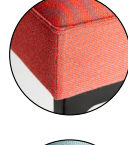

Pinch

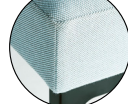

Standard

3. End Panel

E29L	29H END PANEL LEFT
E29R	29H END PANEL RIGHT

4. Dual Upholstery

Dual Upholstery	29H Single			29H Single Plus			29H Double			29H Triple		
	C	P	S	C	P	S	C	P	S	C	P	S
DF1 Seat Cushion, Back Panel, and End Panel Back Cushion	3.3 yds	3.3	3.3	3.3	3.3	3.0	5.0	4.4	4.4	7.2	6.1	6.1
	1.1 yds	1.1	1.1	1.4	1.7	1.7	1.7	2.2	1.7	2.8	3.3	2.8
DF2 Back Panel and End Panel Seat and Back Cushions	2.2 yds	2.2	2.2	2.2	2.2	1.9	2.2	2.2	3.9	3.3	3.3	3.3
	2.8 yds	2.2	2.2	3.3	2.8	1.9	3.9	4.4	2.2	6.1	6.1	5.5

5. Power

Power
Refer to under mount power ordering steps on page 12.

6. Upholstery

Upholstery
See general information section for details on textile program and COM/ COL information.

Yardages provided are for fabrics cut railroaded. While that is generally our preference for Free Address, there may be exceptions if we decide that up the roll is more visually pleasing. If COM fabrics are to be cut up the roll, please contact customer service. Select highest grade in the case of dual upholstery.

Free Address

SEATS: 29H TASK, END PANEL BOTH

*Height when mounted on a frame.

Textile Upholstery Grades

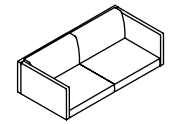
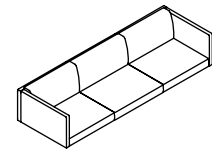
TITLE		SERIES	MODEL	SEAM	PANELS	DIMENSIONS	YDG	COM	A	B	C	D	E	F	G	H	I	J	K	L	M	
Seat, 29H, Double End Panel Both		Casual Seam	FA	12	C	E29B	60W x 30D x 30.5H	6.6	4,091	4,582	4,852	5,114	5,382	5,651	5,945	6,239	6,587	7,031	7,571	8,102	8,640	9,171
		Pinch Seam	FA	12	P	E29B	60W x 30D x 30.5H	6.6	4,161	4,653	4,921	5,183	5,453	5,722	6,014	6,309	6,658	7,101	7,640	8,170	8,710	9,241
		Standard Seam	FA	12	S	E29B	60W x 30D x 30.5H	6.6	4,152	4,644	4,912	5,174	5,443	5,714	6,006	6,298	6,648	7,092	7,630	8,162	8,700	9,232
Seat, 29H, Triple End Panel Both		Casual Seam	FA	13	C	E29B	90W x 30D x 30.5H	8.8	5,324	5,979	6,338	6,686	7,046	7,405	7,796	8,187	8,652	9,244	9,962	10,670	11,390	12,097
		Pinch Seam	FA	13	P	E29B	90W x 30D x 30.5H	8.8	5,429	6,085	6,443	6,792	7,151	7,510	7,902	8,292	8,758	9,349	10,068	10,775	11,494	12,203
		Standard Seam	FA	13	S	E29B	90W x 30D x 30.5H	8.3	5,413	6,028	6,364	6,690	7,028	7,365	7,730	8,097	8,534	9,088	9,761	10,425	11,099	11,763

To Order Select Below

1. Series/Model

FA12
Free Address Seat, 29H, Double

FA13
Free Address Seat, 29H, Triple

2. Upholstery Style

Upholstery Style

C CASUAL

P PINCH

S STANDARD

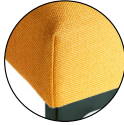
 **Casual**

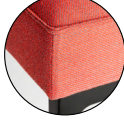
 **Pinch**

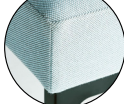
 **Standard**

3. End Panel

End Panel

E29B 29H END PANEL BOTH

4. Dual Upholstery

Dual Upholstery

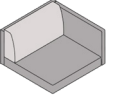
	Dual Upholstery	29H Double			29H Triple		
		C	P	S	C	P	S
 DF1	DUAL UPHOLSTERY STYLE 1 Seat Cushion, Back Panel, and End Panels Back Cushion	6.1 yds	5.0	5.0	7.7	6.1	6.1
		1.7 yds	2.2	1.7	2.8	3.3	2.8
<hr/>							
DF2	DUAL UPHOLSTERY STYLE 2 Back Panel and End Panels Seat and Back Cushions	3.3 yds	3.3	3.3	3.9	3.9	3.9
		3.3 yds	4.4	3.9	6.1	6.1	5.5

5. Power

Power

Refer to under mount power ordering steps on page 12.

6. Upholstery

Upholstery

See general information section for details on textile program and COM/COL information.

Yardages provided are for fabrics cut railroaded. While that is generally our preference for Free Address, there may be exceptions if we decide that up the roll is more visually pleasing. If COM fabrics are to be cut up the roll, please contact customer service. Select highest grade in the case of dual upholstery.

Free Address

SEATS: 36H TASK

*Height when mounted on a frame.

Textile Upholstery Grades

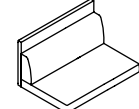
TITLE		SERIES	MODEL	SEAM	PANELS	DIMENSIONS	YDG	COM	A	B	C	D	E	F	G	H	I	J	K	L	M	
Seat, 36H, Single		Casual Seam	FA	21	C	-	30W x 30D x 36.5H	3.6	2,156	2,422	2,568	2,709	2,856	3,001	3,161	3,319	3,508	3,748	4,040	4,328	4,620	4,908
		Pinch Seam	FA	21	P	-	30W x 30D x 36.5H	3	2,230	2,455	2,578	2,699	2,822	2,945	3,079	3,214	3,375	3,578	3,824	4,067	4,315	4,558
		Standard Seam	FA	21	S	-	30W x 30D x 36.5H	3	2,230	2,455	2,578	2,699	2,822	2,945	3,079	3,214	3,375	3,578	3,824	4,067	4,315	4,558
Seat, 36H, Single Plus		Casual Seam	FA	215	C	-	45W x 30D x 36.5H	5	2,567	2,935	3,138	3,333	3,536	3,738	3,957	4,177	4,439	4,773	5,176	5,573	5,979	6,377
		Pinch Seam	FA	215	P	-	45W x 30D x 36.5H	4.4	2,660	2,988	3,168	3,343	3,521	3,700	3,896	4,092	4,324	4,621	4,980	5,334	5,693	6,047
		Standard Seam	FA	215	S	-	45W x 30D x 36.5H	4.4	2,660	2,988	3,168	3,343	3,521	3,700	3,896	4,092	4,324	4,621	4,980	5,334	5,693	6,047
Seat, 36H, Double		Casual Seam	FA	22	C	-	60W x 30D x 36.5H	6.1	3,518	3,968	4,215	4,454	4,702	4,949	5,218	5,486	5,806	6,212	6,707	7,194	7,687	8,173
		Pinch Seam	FA	22	P	-	60W x 30D x 36.5H	5.8	3,666	4,097	4,331	4,560	4,795	5,030	5,288	5,544	5,850	6,238	6,709	7,175	7,646	8,110
		Standard Seam	FA	22	S	-	60W x 30D x 36.5H	5.2	3,666	4,055	4,268	4,475	4,688	4,900	5,133	5,366	5,642	5,994	6,419	6,840	7,268	7,687
Seat, 36H, Triple		Casual Seam	FA	23	C	-	90W x 30D x 36.5H	9.1	5,142	5,818	6,188	6,548	6,918	7,288	7,692	8,095	8,576	9,185	9,927	10,657	11,397	12,127
		Pinch Seam	FA	23	P	-	90W x 30D x 36.5H	8.8	5,365	6,021	6,380	6,728	7,089	7,447	7,838	8,230	8,694	9,286	10,005	10,713	11,430	12,139
		Standard Seam	FA	23	S	-	90W x 30D x 36.5H	7.7	5,365	5,939	6,252	6,558	6,872	7,187	7,530	7,871	8,278	8,796	9,424	10,043	10,674	11,292

To Order Select Below

1. Series/Model

- FA21
Free Address Seat, 36H, Single
- FA215
Free Address Seat, 36H, Single Plus
- FA22
Free Address Seat, 36H, Double
- FA23
Free Address Seat, 36H, Triple

2. Upholstery Style

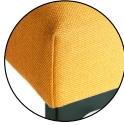
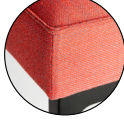
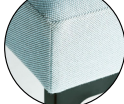
- Upholstery Style
 - C CASUAL
 - P PINCH
 - S STANDARD
-  Casual
-  Pinch
-  Standard

3. Dual Upholstery

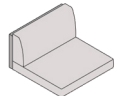
Dual Upholstery	36H Single			36H Single Plus			36H Double			36H Triple		
	C	P	S	C	P	S	C	P	S	C	P	S
DF1 DUAL UPHOLSTERY STYLE 1  Seat Cushion and Back Panel Back Cushion	3.6 yds	3.0	3.0	5.0	4.4	4.4	5.0	4.4	4.4	7.4	6.3	6.3
	1.1 yds	1.1	1.1	1.7	1.7	1.7	1.7	2.2	1.7	2.5	3.0	2.2
DF2 DUAL UPHOLSTERY STYLE 2  Back Panel Seat and Back Cushions	2.2 yds	2.2	2.2	3.0	3.0	3.0	2.5	2.5	2.5	3.3	3.3	3.3
	2.5 yds	2.2	2.2	3.3	3.0	3.0	3.9	3.9	3.6	6.1	5.8	5.2

4. Power

- Power
Refer to under mount power ordering steps on [page 12](#).

5. Upholstery

- Upholstery
See [general information section](#) for details on textile program and COM/COL information.
- Yardages provided are for fabrics cut railroaded. While that is generally our preference for Free Address, there may be exceptions if we decide that up the roll is more visually pleasing. If COM fabrics are to be cut up the roll, please contact customer service. Select highest grade in the case of dual upholstery.

Free Address

SEATS: 36H TASK CORNER

*Height when mounted on a frame.

Textile Upholstery Grades

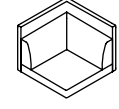
TITLE		SERIES	MODEL	SEAM	PANELS	DIMENSIONS	YDG	COM	A	B	C	D	E	F	G	H	I	J	K	L	M	
Seat, 36H, Corner		Casual Seam	FA	24	C	-	30W x 30D x 36.5H	4.1	3,160	3,466	3,635	3,799	3,968	4,134	4,319	4,501	4,720	4,997	5,334	5,665	6,003	6,335
		Pinch Seam	FA	24	P	-	30W x 30D x 36.5H	4.7	3,207	3,555	3,746	3,931	4,123	4,314	4,521	4,729	4,976	5,289	5,672	6,048	6,429	6,807
		Standard Seam	FA	24	S	-	30W x 30D x 36.5H	4.1	3,207	3,514	3,684	3,846	4,014	4,184	4,366	4,550	4,766	5,045	5,381	5,715	6,050	6,382

To Order Select Below

1. Series/Model

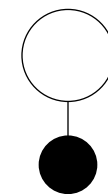

FA24

**Free Address
Seat, 36H, Corner**

2. Upholstery Style

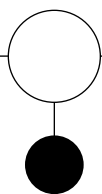

Upholstery Style

- C CASUAL
- P PINCH
- S STANDARD

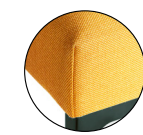

Casual

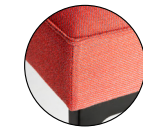

Pinch

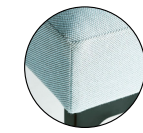

Standard

3. Dual Upholstery

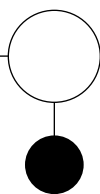

Dual Upholstery

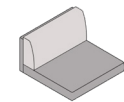
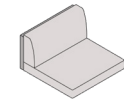
		36H Corner		
DF1	DUAL UPHOLSTERY STYLE 1	C	P	S
	Seat Cushion and Back Panel	3.3 yds	3.0	3.0
	Back Cushion	1.4 yds	1.7	1.4
DF2	DUAL UPHOLSTERY STYLE 2	C	P	S
	Back Panel	2.2 yds	2.2	2.2
	Seat and Back Cushions	2.2 yds	2.5	2.2

4. Upholstery

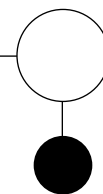

Upholstery

See general information section for details on textile program and COM/COL information.

Yardages provided are for fabrics cut railroaded. While that is generally our preference for Free Address, there may be exceptions if we decide that up the roll is more visually pleasing. If COM fabrics are to be cut up the roll, please contact customer service. Select highest grade in the case of dual upholstery.

Free Address

SEATS: 36H TASK, END PANEL LEFT/RIGHT

*Height when mounted on a frame.

Textile Upholstery Grades

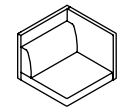
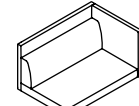
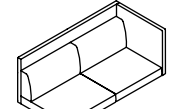
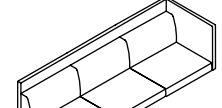
TITLE	SERIES	MODEL	SEAM	PANELS	DIMENSIONS	YDG	COM	A	B	C	D	E	F	G	H	I	J	K	L	M	
Seat, 36H, Single End Panel Left or Right 	Casual Seam	FA	21	C	E36L/R	30W x 30D x 36.5H	4.4	2,760	3,089	3,269	3,443	3,622	3,801	3,997	4,192	4,425	4,721	5,081	5,435	5,793	6,146
	Pinch Seam	FA	21	P	E36L/R	30W x 30D x 36.5H	3.9	2,876	3,162	3,320	3,473	3,629	3,786	3,957	4,129	4,332	4,591	4,906	5,216	5,529	5,839
	Standard Seam	FA	21	S	E36L/R	30W x 30D x 36.5H	4.1	2,876	3,183	3,350	3,514	3,684	3,851	4,035	4,217	4,436	4,713	5,050	5,381	5,719	6,050
Seat, 36H, Single Plus End Panel Left or Right 	Casual Seam	FA	215	C	E36L/R	45W x 30D x 36.5H	5.8	3,241	3,671	3,907	4,136	4,372	4,608	4,864	5,120	5,426	5,814	6,286	6,751	7,223	7,687
	Pinch Seam	FA	215	P	E36L/R	45W x 30D x 36.5H	5.5	3,335	3,744	3,970	4,187	4,412	4,635	4,880	5,126	5,415	5,786	6,234	6,678	7,125	7,569
	Standard Seam	FA	215	S	E36L/R	45W x 30D x 36.5H	5.5	3,335	3,744	3,970	4,187	4,412	4,635	4,880	5,126	5,415	5,786	6,234	6,678	7,125	7,569
Seat, 36H, Double End Panel Left or Right 	Casual Seam	FA	22	C	E36L/R	60W x 30D x 36.5H	6.9	4,130	4,643	4,922	5,195	5,476	5,756	6,062	6,368	6,731	7,193	7,754	8,308	8,869	9,421
	Pinch Seam	FA	22	P	E36L/R	60W x 30D x 36.5H	6.3	4,280	4,751	5,009	5,260	5,518	5,775	6,057	6,338	6,673	7,097	7,614	8,122	8,639	9,149
	Standard Seam	FA	22	S	E36L/R	60W x 30D x 36.5H	6.3	4,280	4,751	5,009	5,260	5,518	5,775	6,057	6,338	6,673	7,097	7,614	8,122	8,639	9,149
Seat, 36H, Triple End Panel Left or Right 	Casual Seam	FA	23	C	E36L/R	90W x 30D x 36.5H	9.9	5,710	6,447	6,852	7,244	7,648	8,053	8,492	8,932	9,455	10,119	10,928	11,725	12,534	13,330
	Pinch Seam	FA	23	P	E36L/R	90W x 30D x 36.5H	8.8	5,932	6,587	6,946	7,296	7,653	8,014	8,405	8,796	9,260	9,852	10,571	11,279	11,997	12,706
	Standard Seam	FA	23	S	E36L/R	90W x 30D x 36.5H	8.8	5,932	6,587	6,946	7,296	7,653	8,014	8,405	8,796	9,260	9,852	10,571	11,279	11,997	12,706

To Order Select Below

1. Series/Model

FA21	Free Address Seat, 36H, Single
FA215	Free Address Seat, 36H, Single Plus
FA22	Free Address Seat, 36H, Double
FA23	Free Address Seat, 36H, Triple

2. Upholstery Style

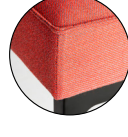
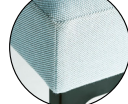
C	CASUAL	
P	PINCH	
S	STANDARD	

3. End Panel

E36L	36H END PANEL LEFT
E36R	36H END PANEL RIGHT

4. Dual Upholstery

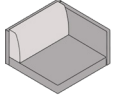
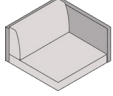
Dual Upholstery	36H Single			36H Single Plus			36H Double			36H Triple		
	C	P	S	C	P	S	C	P	S	C	P	S
DF1 Dual Upholstery Style 1  Seat Cushion, Back Panel, and End Panel Back Cushion	4.1 yds	3.9	3.9	5.2	4.7	4.7	6.1	5.2	5.2	8.3	7.2	7.2
	1.1 yds	1.1	1.1	1.4	1.7	1.4	1.7	1.9	1.7	2.2	3.0	2.2
DF2 Dual Upholstery Style 2  Back Panel and End Panel Seat and Back Cushions	3.0 yds	3.0	3.0	3.3	3.3	3.3	3.3	3.3	3.3	4.4	4.4	4.4
	2.2 yds	1.9	1.9	3.9	2.8	2.8	3.9	3.9	3.3	6.1	5.0	5.2

5. Power

Power
Refer to under mount power ordering steps on page 12.

6. Upholstery

Upholstery
See general information section for details on textile program and COM/ COL information.

Yardages provided are for fabrics cut railroaded. While that is generally our preference for Free Address, there may be exceptions if we decide that up the roll is more visually pleasing. If COM fabrics are to be cut up the roll, please contact customer service. Select highest grade in the case of dual upholstery.

Free Address

SEATS: 36H TASK, END PANEL BOTH

*Height when mounted on a frame.

Textile Upholstery Grades

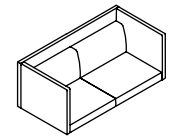
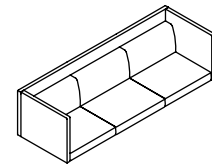
TITLE		SERIES	MODEL	SEAM	PANELS	DIMENSIONS	YDG	COM	A	B	C	D	E	F	G	H	I	J	K	L	M	
Seat, 36H, Double End Panel Both		Casual Seam	FA	22	C	E36B	60W x 30D x 36.5H	7.7	4,860	5,434	5,747	6,053	6,367	6,681	7,023	7,365	7,772	8,290	8,918	9,539	10,168	10,787
		Pinch Seam	FA	22	P	E36B	60W x 30D x 36.5H	7.2	5,008	5,540	5,832	6,115	6,407	6,699	7,016	7,335	7,712	8,193	8,777	9,352	9,936	10,510
		Standard Seam	FA	22	S	E36B	60W x 30D x 36.5H	7.2	5,008	5,540	5,832	6,115	6,407	6,699	7,016	7,335	7,712	8,193	8,777	9,352	9,936	10,510
Seat, 36H, Triple End Panel Both		Casual Seam	FA	23	C	E36B	90W x 30D x 36.5H	10.7	6,263	7,061	7,498	7,925	8,362	8,799	9,276	9,753	10,320	11,041	11,916	12,778	13,654	14,518
		Pinch Seam	FA	23	P	E36B	90W x 30D x 36.5H	9.6	6,485	7,203	7,595	7,976	8,370	8,762	9,189	9,617	10,126	10,773	11,559	12,334	13,120	13,893
		Standard Seam	FA	23	S	E36B	90W x 30D x 36.5H	9.9	6,485	7,223	7,626	8,019	8,423	8,828	9,267	9,706	10,229	10,896	11,704	12,501	13,309	14,106

To Order Select Below

1. Series/Model

FA22

Free Address Seat, 36H, Double

FA23

Free Address Seat, 36H, Triple

2. Upholstery Style

Upholstery Style

C CASUAL

P PINCH

S STANDARD

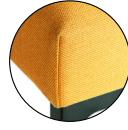
 **Casual**

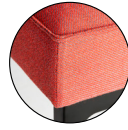
 **Pinch**

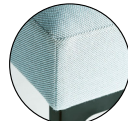
 **Standard**

3. End Panel

End Panel

E36B 36H END PANEL BOTH

4. Dual Upholstery

Dual Upholstery

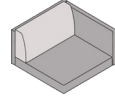
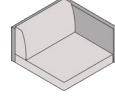
	Dual Upholstery	36H Double			36H Triple		
		C	P	S	C	P	S
	DF1 DUAL UPHOLSTERY STYLE 1 Seat Cushion, Back Panel, and End Panels Back Cushion	6.9 yds	6.1	6.3	9.1	8.0	8.3
		1.4 yds	1.9	1.4	2.2	3.0	2.2
	DF2 DUAL UPHOLSTERY STYLE 2 Back Panel and End Panels Seat and Back Cushions	4.4 yds	4.4	4.4	5.2	5.2	5.2
		3.6 yds	3.9	3.3	5.8	5.8	5.0

5. Power

Power

Refer to under mount power ordering steps on page 12.

6. Upholstery

Upholstery

See general information section for details on textile program and COM/COL information.

Yardages provided are for fabrics cut railroaded. While that is generally our preference for Free Address, there may be exceptions if we decide that up the roll is more visually pleasing. If COM fabrics are to be cut up the roll, please contact customer service. Select highest grade in the case of dual upholstery.

Free Address

SEATS: 36H BANQUETTE

*Height when mounted on a frame.

Textile Upholstery Grades

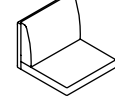
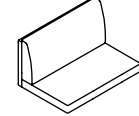
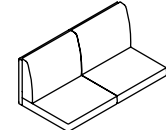
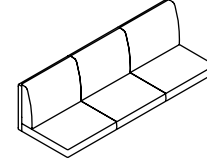
TITLE		SERIES	MODEL	SEAM	PANELS	DIMENSIONS	YDG	COM	A	B	C	D	E	F	G	H	I	J	K	L	M
Seat, 36H Banquette, Single 	Casual Seam	FA	21	C	BQ	30W x 30D x 37.5H	4.4	2,387	2,714	2,894	3,069	3,248	3,427	3,623	3,819	4,052	4,347	4,707	5,061	5,419	5,774
	Pinch Seam	FA	21	P	BQ	30W x 30D x 37.5H	4.1	2,230	2,455	2,578	2,699	2,822	2,945	3,079	3,214	3,375	3,578	3,824	4,067	4,315	4,558
	Standard Seam	FA	21	S	BQ	30W x 30D x 37.5H	4.1	2,230	2,455	2,578	2,699	2,820	2,946	3,080	3,214	3,373	3,578	3,823	4,068	4,316	4,558
Seat, 36H Banquette, Single Plus 	Casual Seam	FA	215	C	BQ	45W x 30D x 37.5H	6.3	2,852	3,322	3,581	3,831	4,089	4,348	4,629	4,910	5,245	5,670	6,186	6,696	7,211	7,721
	Pinch Seam	FA	215	P	BQ	45W x 30D x 37.5H	5.8	2,948	3,378	3,613	3,843	4,079	4,315	4,571	4,827	5,132	5,520	5,991	6,457	6,928	7,394
	Standard Seam	FA	215	S	BQ	45W x 30D x 37.5H	5.8	2,948	3,378	3,613	3,843	4,079	4,315	4,571	4,827	5,132	5,520	5,991	6,457	6,928	7,394
Seat, 36H Banquette, Double 	Casual Seam	FA	22	C	BQ	60W x 30D x 37.5H	6.9	3,951	4,463	4,743	5,016	5,297	5,576	5,882	6,188	6,551	7,014	7,575	8,128	8,689	9,242
	Pinch Seam	FA	22	P	BQ	60W x 30D x 37.5H	6.3	4,103	4,573	4,832	5,082	5,340	5,598	5,880	6,161	6,495	6,920	7,437	7,946	8,461	8,972
	Standard Seam	FA	22	S	BQ	60W x 30D x 37.5H	6.3	4,103	4,573	4,832	5,082	5,340	5,598	5,880	6,161	6,495	6,920	7,437	7,946	8,461	8,972
Seat, 36H Banquette, Triple 	Casual Seam	FA	23	C	BQ	90W x 30D x 37.5H	10.2	5,730	6,488	6,902	7,307	7,722	8,137	8,589	9,041	9,579	10,263	11,095	11,912	12,742	13,562
	Pinch Seam	FA	23	P	BQ	90W x 30D x 37.5H	9.1	5,958	6,634	7,004	7,364	7,734	8,106	8,508	8,911	9,391	10,001	10,743	11,472	12,213	12,944
	Standard Seam	FA	23	S	BQ	90W x 30D x 37.5H	9.1	5,958	6,634	7,004	7,364	7,734	8,106	8,508	8,911	9,391	10,001	10,743	11,472	12,213	12,944

To Order Select Below

1. Series/Model

<input type="radio"/>	FA21	Free Address Seat, 36H, Single
<input type="radio"/>	FA215	Free Address Seat, 36H, Single Plus
<input type="radio"/>	FA22	Free Address Seat, 36H, Double
<input type="radio"/>	FA23	Free Address Seat, 36H, Triple

2. Upholstery Style

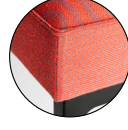
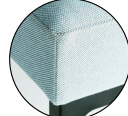
<input type="radio"/>	Upholstery Style
<input type="radio"/>	C CASUAL
<input type="radio"/>	P PINCH
<input type="radio"/>	S STANDARD
<input type="radio"/>	 Casual
<input type="radio"/>	 Pinch
<input type="radio"/>	 Standard

3. Banquette

<input type="radio"/>	Banquette
<input type="radio"/>	BQ BANQUETTE

4. Dual Upholstery

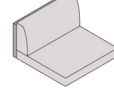
<input type="radio"/>	Dual Upholstery	36H Single	36H Single Plus	36H Double	36H Triple
<input type="radio"/>	DF1 DUAL UPHOLSTERY STYLE 1	C P S	C P S	C P S	C P S
<input type="radio"/>	 Seat Cushion and Back Panel Back Cushion	3.6 yds 3.0 3.0 1.4 yds 1.4 1.4	5.0 4.4 4.4 1.9 1.9 1.9	5.0 4.4 4.4 2.5 2.5 2.5	7.4 6.3 6.3 3.9 3.9 3.9
<input type="radio"/>	DF2 DUAL UPHOLSTERY STYLE 2	C P S	C P S	C P S	C P S
<input type="radio"/>	 Back Panel Seat and Back Cushions	2.2 yds 2.2 2.2 2.8 yds 2.2 2.2	3.0 3.0 3.0 3.6 3.0 3.0	2.5 2.5 2.5 5.2 4.1 4.1	3.3 3.3 3.3 7.7 6.1 6.1

5. Power

<input type="radio"/>	Power
<input type="radio"/>	Refer to under mount power ordering steps on page 12.

6. Upholstery

<input type="radio"/>	Upholstery
<input type="radio"/>	See general information section for details on textile program and COM/ COL information.
<input type="radio"/>	Yardages provided are for fabrics cut railroaded. While that is generally our preference for Free Address, there may be exceptions if we decide that up the roll is more visually pleasing. If COM fabrics are to be cut up the roll, please contact customer service. Select highest grade in the case of dual upholstery.

Free Address

SEATS: 36H BANQUETTE CORNER

*Height when mounted on a frame.

Textile Upholstery Grades

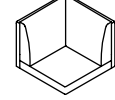
TITLE		SERIES	MODEL	SEAM	PANELS	DIMENSIONS	YDG	COM	A	B	C	D	E	F	G	H	I	J	K	L	M
Seat, 36H Banquette, Corner 	Casual Seam	FA	24	C	BQ	30W x 30D x 37.5H	5	3,443	3,810	4,013	4,210	4,411	4,613	4,833	5,053	5,313	5,648	6,051	6,450	6,855	7,252
	Pinch Seam	FA	24	P	BQ	30W x 30D x 37.5H	4.7	3,492	3,840	4,031	4,216	4,408	4,599	4,806	5,014	5,261	5,574	5,957	6,334	6,716	7,091
	Standard Seam	FA	24	S	BQ	30W x 30D x 37.5H	4.7	3,492	3,840	4,031	4,216	4,408	4,599	4,806	5,014	5,261	5,574	5,957	6,334	6,716	7,091

To Order Select Below

1. Series/Model

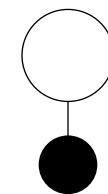

FA24

**Free Address
Seat, 36H, Corner**

2. Upholstery Style

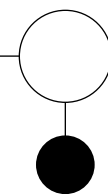

Upholstery Style

C CASUAL

P PINCH

S STANDARD

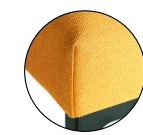

Casual

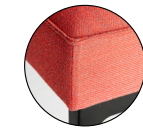

Pinch

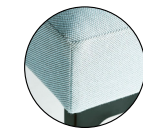

Standard

3. Banquette

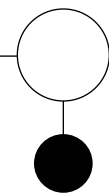

Banquette

BQ BANQUETTE

4. Dual Upholstery

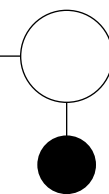

Dual Upholstery

DF1 DUAL UPHOLSTERY STYLE 1

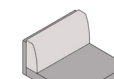
 Seat Cushion and Back Panel
Back Cushion

DF2 DUAL UPHOLSTERY STYLE 2

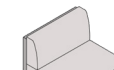
 Back Panel
Seat and Back Cushions

36H Corner

C P S

3.3 yds 3.0 3.0
2.2 yds 2.2 2.2

C P S

2.2 yds 2.2 2.2
3.0 yds 2.8 2.8

5. Upholstery

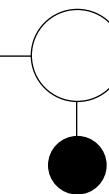

Upholstery

See general information section for details on textile program and COM/COL information.

Yardages provided are for fabrics cut railroaded. While that is generally our preference for Free Address, there may be exceptions if we decide that up the roll is more visually pleasing. If COM fabrics are to be cut up the roll, please contact customer service. Select highest grade in the case of dual upholstery.

Free Address

SEATS: 36H BANQUETTE, END PANEL LEFT/RIGHT

*Height when mounted on a frame.

Textile Upholstery Grades

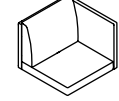
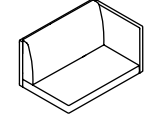
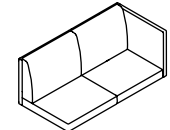
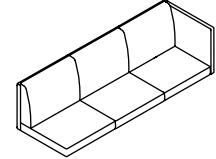
TITLE		SERIES	MODEL	SEAM	PANELS	DIMENSIONS	YDG	COM	A	B	C	D	E	F	G	H	I	J	K	L	M
Seat, 36H Banquette, Single End Panel Left or Right 	Casual Seam	FA	21	C	BQE36L/R	30W x 30D x 37.5H	5.2	3,045	3,433	3,646	3,853	4,067	4,281	4,513	4,744	5,021	5,372	5,799	6,220	6,646	7,067
	Pinch Seam	FA	21	P	BQE36L/R	30W x 30D x 37.5H	4.7	3,166	3,513	3,703	3,890	4,080	4,271	4,478	4,686	4,934	5,247	5,630	6,005	6,387	6,764
	Standard Seam	FA	21	S	BQE36L/R	30W x 30D x 37.5H	4.7	3,166	3,513	3,703	3,890	4,080	4,271	4,478	4,686	4,934	5,247	5,630	6,005	6,387	6,764
Seat, 36H Banquette, Single Plus End Panel Left or Right 	Casual Seam	FA	215	C	BQE36L/R	45W x 30D x 37.5H	6.6	3,499	3,992	4,260	4,522	4,790	5,061	5,353	5,647	5,997	6,440	6,978	7,509	8,049	8,579
	Pinch Seam	FA	215	P	BQE36L/R	45W x 30D x 37.5H	6.1	3,596	4,046	4,293	4,532	4,780	5,026	5,295	5,564	5,883	6,291	6,785	7,272	7,766	8,252
	Standard Seam	FA	215	S	BQE36L/R	45W x 30D x 37.5H	6.1	3,596	4,046	4,293	4,532	4,780	5,026	5,295	5,564	5,883	6,291	6,785	7,272	7,766	8,252
Seat, 36H Banquette, Double End Panel Left or Right 	Casual Seam	FA	22	C	BQE36L/R	60W x 30D x 37.5H	7.7	4,614	5,189	5,503	5,808	6,121	6,438	6,779	7,121	7,529	8,045	8,674	9,293	9,922	10,542
	Pinch Seam	FA	22	P	BQE36L/R	60W x 30D x 37.5H	7.2	4,766	5,299	5,591	5,874	6,166	6,458	6,777	7,094	7,471	7,952	8,536	9,111	9,696	10,271
	Standard Seam	FA	22	S	BQE36L/R	60W x 30D x 37.5H	7.2	4,766	5,299	5,591	5,874	6,166	6,458	6,777	7,094	7,471	7,952	8,536	9,111	9,696	10,271
Seat, 36H Banquette, Triple End Panel Left or Right 	Casual Seam	FA	23	C	BQE36L/R	90W x 30D x 37.5H	11	6,426	7,245	7,694	8,131	8,579	9,027	9,518	10,006	10,587	11,327	12,225	13,109	14,008	14,893
	Pinch Seam	FA	23	P	BQE36L/R	90W x 30D x 37.5H	9.9	6,655	7,391	7,796	8,188	8,592	8,996	9,436	9,876	10,399	11,066	11,874	12,669	13,477	14,275
	Standard Seam	FA	23	S	BQE36L/R	90W x 30D x 37.5H	9.9	6,655	7,391	7,796	8,188	8,592	8,996	9,436	9,876	10,399	11,066	11,874	12,669	13,477	14,275

To Order Select Below

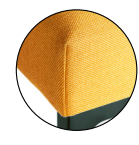
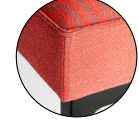
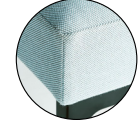
<p>1. Series/Model</p> <p>FA21 Free Address Seat, 36H, Single</p> <p>FA215 Free Address Seat, 36H, Single Plus</p> <p>FA22 Free Address Seat, 36H, Double</p> <p>FA23 Free Address Seat, 36H, Triple</p>	<p>2. Upholstery Style</p> <p>C CASUAL P PINCH S STANDARD</p>  Casual  Pinch  Standard	<p>3. Banquette</p> <p>BQ BANQUETTE</p>	<p>4. End Panel</p> <p>E36L 36H END PANEL LEFT E36R 36H END PANEL RIGHT</p>	<p>5. Dual Upholstery</p> <table border="1"> <thead> <tr> <th rowspan="2">Dual Upholstery</th> <th colspan="3">36H Single</th> <th colspan="3">36H Single Plus</th> <th colspan="3">36H Double</th> <th colspan="3">36H Triple</th> </tr> <tr> <th>C</th> <th>P</th> <th>S</th> <th>C</th> <th>P</th> <th>S</th> <th>C</th> <th>P</th> <th>S</th> <th>C</th> <th>P</th> <th>S</th> </tr> </thead> <tbody> <tr> <td>DF1 Seat Cushion, Back Panel, and End Panel Back Cushion</td> <td>4.1 yds</td> <td>3.9</td> <td>3.9</td> <td>5.2</td> <td>4.7</td> <td>4.7</td> <td>6.1</td> <td>5.2</td> <td>5.2</td> <td>8.3</td> <td>7.2</td> <td>7.2</td> </tr> <tr> <td></td> <td>1.4 yds</td> <td>1.4</td> <td>1.4</td> <td>1.7</td> <td>1.7</td> <td>1.7</td> <td>2.5</td> <td>2.5</td> <td>2.5</td> <td>3.9</td> <td>3.9</td> <td>3.9</td> </tr> <tr> <td>DF2 Back Panel and End Panel Seat and Back Cushions</td> <td>3.0 yds</td> <td>3.0</td> <td>3.0</td> <td>3.3</td> <td>3.3</td> <td>3.3</td> <td>3.3</td> <td>3.3</td> <td>3.3</td> <td>4.4</td> <td>4.4</td> <td>4.4</td> </tr> <tr> <td></td> <td>2.5 yds</td> <td>2.2</td> <td>2.2</td> <td>3.6</td> <td>2.8</td> <td>2.8</td> <td>5.0</td> <td>4.1</td> <td>4.1</td> <td>7.7</td> <td>5.8</td> <td>5.8</td> </tr> </tbody> </table>	Dual Upholstery	36H Single			36H Single Plus			36H Double			36H Triple			C	P	S	C	P	S	C	P	S	C	P	S	DF1 Seat Cushion, Back Panel, and End Panel Back Cushion	4.1 yds	3.9	3.9	5.2	4.7	4.7	6.1	5.2	5.2	8.3	7.2	7.2		1.4 yds	1.4	1.4	1.7	1.7	1.7	2.5	2.5	2.5	3.9	3.9	3.9	DF2 Back Panel and End Panel Seat and Back Cushions	3.0 yds	3.0	3.0	3.3	3.3	3.3	3.3	3.3	3.3	4.4	4.4	4.4		2.5 yds	2.2	2.2	3.6	2.8	2.8	5.0	4.1	4.1	7.7	5.8	5.8	<p>6. Power</p> <p>Refer to under mount power ordering steps on page 12.</p>	<p>7. Upholstery</p> <p>See general information section for details on textile program and COM/ COL information.</p> <p>Yardages provided are for fabrics cut railroaded. While that is generally our preference for Free Address, there may be exceptions if we decide that up the roll is more visually pleasing. If COM fabrics are to be cut up the roll, please contact customer service. Select highest grade in the case of dual upholstery.</p>
Dual Upholstery	36H Single			36H Single Plus			36H Double			36H Triple																																																																									
	C	P	S	C	P	S	C	P	S	C	P	S																																																																							
DF1 Seat Cushion, Back Panel, and End Panel Back Cushion	4.1 yds	3.9	3.9	5.2	4.7	4.7	6.1	5.2	5.2	8.3	7.2	7.2																																																																							
	1.4 yds	1.4	1.4	1.7	1.7	1.7	2.5	2.5	2.5	3.9	3.9	3.9																																																																							
DF2 Back Panel and End Panel Seat and Back Cushions	3.0 yds	3.0	3.0	3.3	3.3	3.3	3.3	3.3	3.3	4.4	4.4	4.4																																																																							
	2.5 yds	2.2	2.2	3.6	2.8	2.8	5.0	4.1	4.1	7.7	5.8	5.8																																																																							

Free Address

SEATS: 36H BANQUETTE, END PANEL BOTH

*Height when mounted on a frame.

Textile Upholstery Grades

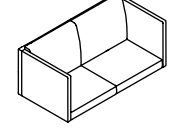
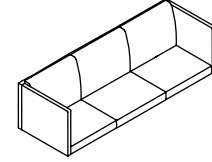
TITLE		SERIES	MODEL	SEAM	PANELS	DIMENSIONS	YDG	COM	A	B	C	D	E	F	G	H	I	J	K	L	M
Seat, 36H Banquette, Double End Panel Both 	Casual Seam	FA	22	C	BQE36B	60W x 30D x 37.5H	8.8	5,232	5,887	6,246	6,595	6,954	7,313	7,705	8,095	8,561	9,152	9,872	10,579	11,296	12,006
	Pinch Seam	FA	22	P	BQE36B	60W x 30D x 37.5H	8	5,384	5,979	6,304	6,620	6,945	7,271	7,624	7,979	8,401	8,937	9,588	10,229	10,880	11,523
	Standard Seam	FA	22	S	BQE36B	60W x 30D x 37.5H	8	5,384	5,979	6,304	6,620	6,945	7,271	7,624	7,979	8,401	8,937	9,588	10,229	10,880	11,523
Seat, 36H Banquette, Triple End Panel Both 	Casual Seam	FA	23	C	BQE36B	90W x 30D x 37.5H	11.8	6,936	7,817	8,299	8,767	9,252	9,733	10,259	10,785	11,409	12,204	13,170	14,121	15,086	16,038
	Pinch Seam	FA	23	P	BQE36B	90W x 30D x 37.5H	11	7,162	7,980	8,430	8,865	9,315	9,764	10,251	10,742	11,322	12,062	12,959	13,846	14,743	15,629
	Standard Seam	FA	23	S	BQE36B	90W x 30D x 37.5H	10.7	7,165	7,963	8,401	8,826	9,263	9,701	10,177	10,655	11,222	11,942	12,819	13,680	14,557	15,420

To Order Select Below

1. Series/Model

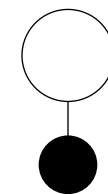

FA22

**Free Address
Seat, 36H, Double**

FA23

**Free Address
Seat, 36H, Triple**

2. Upholstery Style

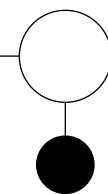

Upholstery Style

C CASUAL

P PINCH

S STANDARD

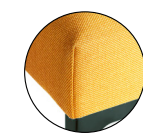

Casual

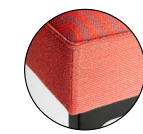

Pinch

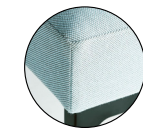

Standard

3. Banquette

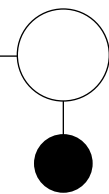

Banquette

BQ BANQUETTE

4. End Panel

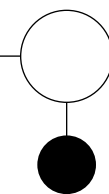

End Panel

E36B 36H END PANEL BOTH

5. Dual Upholstery

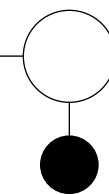

Dual Upholstery

DF1 DUAL UPHOLSTERY STYLE 1

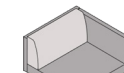
 Seat Cushion, Back Panel, and End Panels
Back Cushion

DF2 DUAL UPHOLSTERY STYLE 2

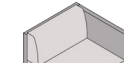
 Back Panel and End Panels
Seat and Back Cushions

36H Double

C P S

6.9 yds 6.1 6.3
2.5 yds 2.5 2.5

36H Triple

C P S

9.1 8.0 8.3
3.6 3.6 3.6

C P S

4.4 yds 4.4 4.4
5.8 yds 5.8 5.8

C P S

5.2 5.2 5.2
7.4 5.8 5.8

6. Power

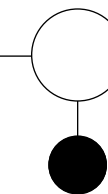

Power

**Refer to under mount
power ordering steps
on page 12.**

7. Upholstery

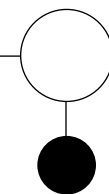

Upholstery

**See general information
section for details on textile
program and COM/COL
information.**

Yardages provided are for fabrics cut railroaded. While that is generally our preference for Free Address, there may be exceptions if we decide that up the roll is more visually pleasing. If COM fabrics are to be cut up the roll, please contact customer service. Select highest grade in the case of dual upholstery.

Free Address

SEATS: 42H TASK

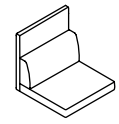
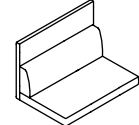
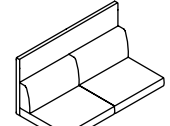
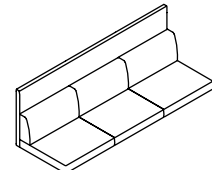

*Height when mounted on a frame.

Textile Upholstery Grades



TITLE		SERIES	MODEL	SEAM	PANELS	DIMENSIONS	YDG	COM	A	B	C	D	E	F	G	H	I	J	K	L	M	
Seat, 42H, Single		Casual Seam	FA	31	C	-	30W x 30D x 42.5H	4.4	2,247	2,576	2,755	2,930	3,109	3,290	3,485	3,681	3,911	4,208	4,568	4,921	5,281	5,635
		Pinch Seam	FA	31	P	-	30W x 30D x 42.5H	4.1	2,322	2,628	2,798	2,962	3,129	3,298	3,481	3,665	3,882	4,159	4,497	4,829	5,166	5,497
		Standard Seam	FA	31	S	-	30W x 30D x 42.5H	4.1	2,322	2,628	2,798	2,962	3,129	3,298	3,481	3,665	3,882	4,159	4,497	4,829	5,166	5,497
Seat, 42H, Single Plus		Casual Seam	FA	315	C	-	45W x 30D x 42.5H	6.3	2,650	3,121	3,379	3,629	3,888	4,145	4,427	4,708	5,042	5,467	5,984	6,492	7,009	7,518
		Pinch Seam	FA	315	P	-	45W x 30D x 42.5H	5.8	2,744	3,173	3,409	3,639	3,874	4,110	4,366	4,624	4,928	5,316	5,789	6,252	6,724	7,188
		Standard Seam	FA	315	S	-	45W x 30D x 42.5H	5.8	2,744	3,173	3,409	3,639	3,874	4,110	4,366	4,624	4,928	5,316	5,789	6,252	6,724	7,188
Seat, 42H, Double		Casual Seam	FA	32	C	-	60W x 30D x 42.5H	6.1	3,655	4,105	4,351	4,593	4,839	5,087	5,354	5,622	5,943	6,350	6,843	7,331	7,825	8,313
		Pinch Seam	FA	32	P	-	60W x 30D x 42.5H	6.3	3,802	4,274	4,532	4,782	5,041	5,299	5,579	5,861	6,195	6,621	7,138	7,646	8,163	8,672
		Standard Seam	FA	32	S	-	60W x 30D x 42.5H	5.5	3,802	4,213	4,437	4,655	4,879	5,104	5,349	5,592	5,882	6,252	6,703	7,145	7,594	8,036
Seat, 42H, Triple		Casual Seam	FA	33	C	-	90W x 30D x 42.5H	9.4	5,203	5,899	6,282	6,652	7,032	7,415	7,830	8,246	8,739	9,369	10,132	10,884	11,647	12,400
		Pinch Seam	FA	33	P	-	90W x 30D x 42.5H	9.1	5,425	6,101	6,471	6,831	7,201	7,572	7,975	8,378	8,858	9,468	10,208	10,939	11,680	12,410
		Standard Seam	FA	33	S	-	90W x 30D x 42.5H	8.3	5,425	6,040	6,375	6,703	7,040	7,377	7,743	8,109	8,546	9,100	9,774	10,437	11,111	11,775

To Order Select Below

1. Series/Model

	
FA31	Free Address Seat, 42H, Single
FA315	Free Address Seat, 42H, Single Plus
FA32	Free Address Seat, 42H, Double
FA33	Free Address Seat, 42H, Triple

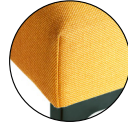
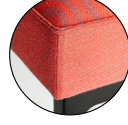

2. Upholstery Style

	Upholstery Style
C	CASUAL
P	PINCH
S	STANDARD
	Casual
	Pinch
	Standard

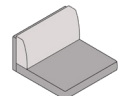
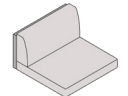

3. Dual Upholstery

	Dual Upholstery	42H Single	42H Single Plus	42H Double	42H Triple
DF1	DUAL UPHOLSTERY STYLE 1	C P S	C P S	C P S	C P S
	Seat Cushion and Back Panel Back Cushion	3.6 yds 3.0 3.0 1.1 yds 1.1 1.1	5.0 4.4 4.4 1.7 1.7 1.7	5.0 4.4 4.4 1.7 2.2 1.7	7.4 6.3 6.3 2.5 3.0 2.2
DF2	DUAL UPHOLSTERY STYLE 2	C P S	C P S	C P S	C P S
	Back Panel Seat and Back Cushions	2.2 yds 2.2 2.2 2.5 yds 2.2 2.2	3.0 3.0 3.0 3.3 3.0 3.0	2.5 2.5 2.5 3.9 3.9 3.6	3.3 3.3 3.3 6.1 5.8 5.2

4. Power

	Power
	Refer to under mount power ordering steps on page 12.

5. Upholstery

	Upholstery
	See general information section for details on textile program and COM/COL information.
	Yardages provided are for fabrics cut railroaded. While that is generally our preference for Free Address, there may be exceptions if we decide that up the roll is more visually pleasing. If COM fabrics are to be cut up the roll, please contact customer service. Select highest grade in the case of dual upholstery.

Free Address

SEATS: 42H TASK CORNER

*Height when mounted on a frame.

Textile Upholstery Grades

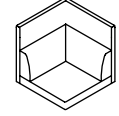
TITLE		SERIES	MODEL	SEAM	PANELS	DIMENSIONS	YDG	COM	A	B	C	D	E	F	G	H	I	J	K	L	M	
Seat, 42H, Corner		Casual Seam	FA	34	C	-	30W x 30D x 42.5H	4.4	3,181	3,509	3,688	3,863	4,041	4,221	4,417	4,612	4,845	5,141	5,501	5,854	6,212	6,569
		Pinch Seam	FA	34	P	-	30W x 30D x 42.5H	5	3,228	3,597	3,799	3,995	4,197	4,398	4,620	4,839	5,101	5,434	5,838	6,237	6,639	7,038
		Standard Seam	FA	34	S	-	30W x 30D x 42.5H	4.1	3,228	3,536	3,703	3,867	4,036	4,205	4,388	4,570	4,788	5,066	5,402	5,735	6,072	6,402

To Order Select Below

1. Series/Model

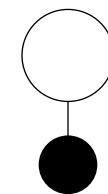

FA34

**Free Address
Seat, 42H, Corner**

2. Upholstery Style

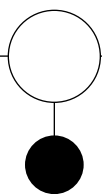

Upholstery Style

C	CASUAL
P	PINCH
S	STANDARD

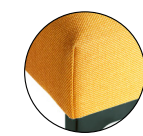

Casual

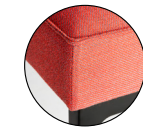

Pinch

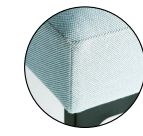

Standard

3. Dual Upholstery

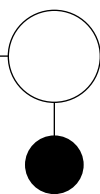

Dual Upholstery

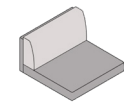
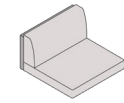
DF1	DUAL UPHOLSTERY STYLE 1	42H Corner		
		C	P	S
	Seat Cushion and Back Panel	3.6 yds	3.3	3.3
	Back Cushion	1.4 yds	1.7	1.4
DF2	DUAL UPHOLSTERY STYLE 2	C	P	S
	Back Panel	2.5 yds	2.5	2.5
	Seat and Back Cushions	2.2 yds	2.5	2.2

4. Upholstery

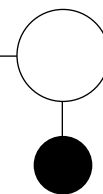

Upholstery

See general information section for details on textile program and COM/COL information.

Yardages provided are for fabrics cut railroaded. While that is generally our preference for Free Address, there may be exceptions if we decide that up the roll is more visually pleasing. If COM fabrics are to be cut up the roll, please contact customer service. Select highest grade in the case of dual upholstery.

Free Address

SEATS: 42H TASK, END PANEL LEFT/RIGHT

*Height when mounted on a frame.

Textile Upholstery Grades

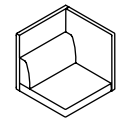
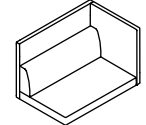
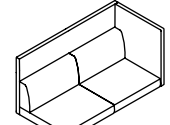
TITLE	SERIES	MODEL	SEAM	PANELS	DIMENSIONS	YDG	COM	A	B	C	D	E	F	G	H	I	J	K	L	M	
Seat, 42H, Single End Panel Left or Right 	Casual Seam	FA	31	C	E42L/R	30W x 30D x 42.5H	6.1	2,789	3,240	3,488	3,727	3,975	4,220	4,491	4,759	5,078	5,485	5,980	6,466	6,960	7,446
	Pinch Seam	FA	31	P	E42L/R	30W x 30D x 42.5H	5.8	2,905	3,334	3,569	3,799	4,035	4,271	4,527	4,783	5,089	5,478	5,949	6,414	6,885	7,351
	Standard Seam	FA	31	S	E42L/R	30W x 30D x 42.5H	5.8	2,905	3,334	3,569	3,799	4,035	4,271	4,527	4,783	5,089	5,478	5,949	6,414	6,885	7,351
Seat, 42H, Single Plus End Panel Left or Right 	Casual Seam	FA	315	C	E42L/R	45W x 30D x 42.5H	7.2	3,276	3,807	4,100	4,384	4,675	4,967	5,284	5,602	5,981	6,460	7,046	7,620	8,204	8,780
	Pinch Seam	FA	315	P	E42L/R	45W x 30D x 42.5H	6.6	3,370	3,862	4,130	4,392	4,660	4,931	5,224	5,517	5,867	6,310	6,849	7,380	7,919	8,450
	Standard Seam	FA	315	S	E42L/R	45W x 30D x 42.5H	6.6	3,370	3,862	4,130	4,392	4,660	4,931	5,224	5,517	5,867	6,310	6,849	7,380	7,919	8,450
Seat, 42H, Double End Panel Left or Right 	Casual Seam	FA	32	C	E42L/R	60W x 30D x 42.5H	8	4,369	4,963	5,288	5,605	5,931	6,256	6,610	6,964	7,386	7,922	8,575	9,215	9,866	10,508
	Pinch Seam	FA	32	P	E42L/R	60W x 30D x 42.5H	8.3	4,517	5,131	5,468	5,795	6,133	6,469	6,836	7,203	7,638	8,193	8,866	9,530	10,203	10,868
	Standard Seam	FA	32	S	E42L/R	60W x 30D x 42.5H	7.2	4,517	5,050	5,341	5,626	5,917	6,209	6,527	6,843	7,223	7,702	8,286	8,862	9,446	10,021
Seat, 42H, Triple End Panel Left or Right 	Casual Seam	FA	33	C	E42L/R	90W x 30D x 42.5H	11.3	5,854	6,694	7,154	7,601	8,061	8,521	9,022	9,523	10,118	10,877	11,798	12,706	13,625	14,533
	Pinch Seam	FA	33	P	E42L/R	90W x 30D x 42.5H	11	6,076	6,895	7,343	7,780	8,230	8,678	9,168	9,655	10,237	10,977	11,876	12,760	13,657	14,542
	Standard Seam	FA	33	S	E42L/R	90W x 30D x 42.5H	10.2	6,076	6,834	7,250	7,651	8,067	8,482	8,935	9,388	9,924	10,610	11,440	12,258	13,089	13,908

To Order Select Below

1. Series/Model

FA31	Free Address Seat, 42H, Single
FA315	Free Address Seat, 42H, Single Plus
FA32	Free Address Seat, 42H, Double
FA33	Free Address Seat, 42H, Triple

2. Upholstery Style

C	CASUAL
P	PINCH
S	STANDARD

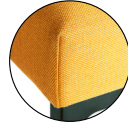

Casual

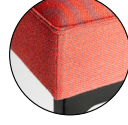

Pinch

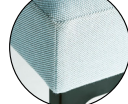

Standard

3. End Panel

E42L	42H END PANEL LEFT
E42R	42H END PANEL RIGHT

4. Dual Upholstery

Dual Upholstery	42H Single			42H Single Plus			42H Double			42H Triple		
	C	P	S	C	P	S	C	P	S	C	P	S
DF1 Seat Cushion, Back Panel, and End Panel Back Cushion	5.2 yds	5.0	4.7	5.8	5.2	5.2	7.2	6.3	6.3	9.4	10.5	8.3
	1.1 yds	1.1	1.1	1.4	1.7	1.4	1.7	1.9	1.7	2.2	3.0	2.2
DF2 Back Panel and End Panel Seat and Back Cushions	3.9 yds	3.9	3.9	3.9	3.9	3.9	4.4	4.4	4.4	5.5	5.5	5.5
	2.2 yds	1.9	1.9	3.9	2.8	2.8	3.9	3.9	3.3	6.1	5.0	5.2

5. Power

Power
Refer to under mount power ordering steps on page 12.

6. Upholstery

Upholstery
See general information section for details on textile program and COM/ COL information.
Yardages provided are for fabrics cut railroaded. While that is generally our preference for Free Address, there may be exceptions if we decide that up the roll is more visually pleasing. If COM fabrics are to be cut up the roll, please contact customer service. Select highest grade in the case of dual upholstery.

Free Address

SEATS: 42H TASK, END PANEL BOTH

*Height when mounted on a frame.

Textile Upholstery Grades

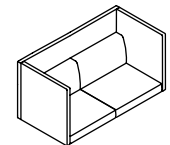
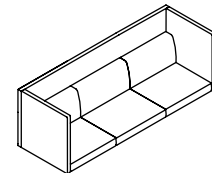
TITLE		SERIES	MODEL	SEAM	PANELS	DIMENSIONS	YDG	COM	A	B	C	D	E	F	G	H	I	J	K	L	M	
Seat, 42H, Double End Panel Both		Casual Seam	FA	32	C	E42B	60W x 30D x 42.5H	9.9	4,992	5,728	6,133	6,526	6,930	7,333	7,773	8,213	8,737	9,403	10,212	11,007	11,814	12,613
		Pinch Seam	FA	32	P	E42B	60W x 30D x 42.5H	10.2	5,140	5,897	6,312	6,716	7,132	7,547	7,999	8,450	8,989	9,672	10,503	11,321	12,152	12,972
		Standard Seam	FA	32	S	E42B	60W x 30D x 42.5H	9.1	5,140	5,815	6,186	6,546	6,916	7,286	7,690	8,093	8,574	9,182	9,923	10,654	11,395	12,124
Seat, 42H, Triple End Panel Both		Casual Seam	FA	33	C	E42B	90W x 30D x 42.5H	13.2	6,364	7,346	7,885	8,408	8,948	9,487	10,072	10,659	11,357	12,245	13,322	14,385	15,463	16,525
		Pinch Seam	FA	33	P	E42B	90W x 30D x 42.5H	12.9	6,587	7,549	8,078	8,589	9,117	9,645	10,219	10,793	11,475	12,345	13,401	14,440	15,496	16,536
		Standard Seam	FA	33	S	E42B	90W x 30D x 42.5H	12.1	6,587	7,488	7,981	8,461	8,956	9,449	9,986	10,525	11,163	11,977	12,967	13,939	14,928	15,902

To Order Select Below

1. Series/Model

FA32
Free Address Seat, 42H, Double

FA33
Free Address Seat, 42H, Triple

2. Upholstery Style

Upholstery Style

C CASUAL

P PINCH

S STANDARD

 **Casual**

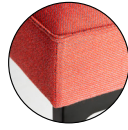
 **Pinch**

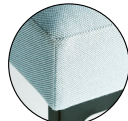
 **Standard**

3. End Panel

End Panel

E42B 42H END PANEL BOTH

4. Dual Upholstery

Dual Upholstery

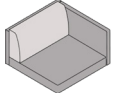
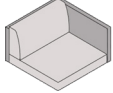
	42H Double			42H Triple		
	C	P	S	C	P	S
DF1 DUAL UPHOLSTERY STYLE 1  Seat Cushion, Back Panel, and End Panels Back Cushion	9.1 yds	8.3	8.3	11.3	10.2	10.2
	1.4 yds	1.9	1.4	2.2	3.0	2.2
DF2 DUAL UPHOLSTERY STYLE 2  Back Panel and End Panels Seat and Back Cushions	6.6 yds	6.6	6.6	7.4	7.4	7.4
	3.6 yds	3.9	3.9	5.8	5.8	5.0

5. Power

Power

Refer to under mount power ordering steps on page 12.

6. Upholstery

Upholstery

See general information section for details on textile program and COM/COL information.

Yardages provided are for fabrics cut railroaded. While that is generally our preference for Free Address, there may be exceptions if we decide that up the roll is more visually pleasing. If COM fabrics are to be cut up the roll, please contact customer service. Select highest grade in the case of dual upholstery.

Free Address

SEATS: 42H BANQUETTE

*Height when mounted on a frame.

Textile Upholstery Grades

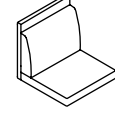
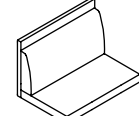
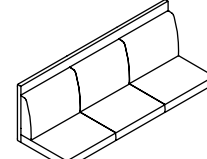
TITLE		SERIES	MODEL	SEAM	PANELS	DIMENSIONS	YDG	COM	A	B	C	D	E	F	G	H	I	J	K	L	M
Seat, 42H Banquette, Single 	Casual Seam	FA	31	C	BQ	30W x 30D x 42.5H	4.4	2,479	2,807	2,987	3,161	3,340	3,520	3,716	3,910	4,143	4,439	4,800	5,153	5,512	5,867
	Pinch Seam	FA	31	P	BQ	30W x 30D x 42.5H	4.1	2,555	2,863	3,032	3,195	3,363	3,533	3,715	3,897	4,115	4,393	4,731	5,062	5,399	5,730
	Standard Seam	FA	31	S	BQ	30W x 30D x 42.5H	4.1	2,555	2,863	3,032	3,195	3,363	3,533	3,715	3,897	4,115	4,393	4,731	5,062	5,399	5,730
Seat, 42H Banquette, Single Plus 	Casual Seam	FA	315	C	BQ	45W x 30D x 42.5H	6.3	2,883	3,353	3,611	3,863	4,122	4,379	4,659	4,940	5,275	5,700	6,217	6,725	7,242	7,751
	Pinch Seam	FA	315	P	BQ	45W x 30D x 42.5H	5.8	2,976	3,407	3,643	3,872	4,108	4,344	4,600	4,856	5,162	5,549	6,022	6,486	6,959	7,424
	Standard Seam	FA	315	S	BQ	45W x 30D x 42.5H	5.8	2,976	3,407	3,643	3,872	4,108	4,344	4,600	4,856	5,162	5,549	6,022	6,486	6,959	7,424
Seat, 42H Banquette, Double 	Casual Seam	FA	32	C	BQ	60W x 30D x 42.5H	7.4	4,089	4,643	4,944	5,240	5,543	5,847	6,177	6,505	6,898	7,398	8,003	8,601	9,208	9,804
	Pinch Seam	FA	32	P	BQ	60W x 30D x 42.5H	6.3	4,241	4,713	4,971	5,221	5,480	5,738	6,018	6,299	6,634	7,060	7,575	8,084	8,601	9,109
	Standard Seam	FA	32	S	BQ	60W x 30D x 42.5H	6.3	4,241	4,713	4,971	5,221	5,480	5,738	6,018	6,299	6,634	7,060	7,575	8,084	8,601	9,109
Seat, 42H Banquette, Triple 	Casual Seam	FA	33	C	BQ	90W x 30D x 42.5H	11	5,682	6,502	6,949	7,386	7,836	8,285	8,773	9,261	9,844	10,583	11,482	12,366	13,264	14,149
	Pinch Seam	FA	33	P	BQ	90W x 30D x 42.5H	9.1	5,911	6,587	6,958	7,316	7,687	8,058	8,460	8,864	9,344	9,954	10,694	11,424	12,166	12,897
	Standard Seam	FA	33	S	BQ	90W x 30D x 42.5H	9.1	5,911	6,587	6,958	7,316	7,687	8,058	8,460	8,864	9,344	9,954	10,694	11,424	12,166	12,897

To Order Select Below

1. Series/Model

<input type="radio"/>	<input checked="" type="radio"/>
FA31	Free Address Seat, 42H, Single
FA315	Free Address Seat, 42H, Single Plus
FA32	Free Address Seat, 42H, Double
FA33	Free Address Seat, 42H, Triple

2. Upholstery Style

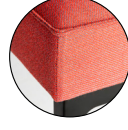
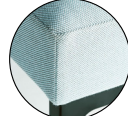
<input type="radio"/>	<input checked="" type="radio"/>
C	CASUAL
P	PINCH
S	STANDARD
	Casual
	Pinch
	Standard

3. Banquette

<input type="radio"/>	<input checked="" type="radio"/>
BQ	BANQUETTE

4. Dual Upholstery

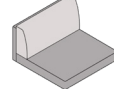
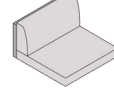
<input type="radio"/>	<input checked="" type="radio"/>												
DF1	DUAL UPHOLSTERY STYLE 1	42H Single			42H Single Plus			42H Double			42H Triple		
	Seat Cushion and Back Panel Back Cushion	C	P	S	C	P	S	C	P	S	C	P	S
		3.6 yds	3.0	3.0	5.0	4.4	4.4	5.0	4.4	4.4	7.4	6.3	6.3
		1.4 yds	1.4	1.4	1.9	1.9	1.9	2.5	2.5	2.5	3.9	3.9	3.9
DF2	DUAL UPHOLSTERY STYLE 2	42H Single			42H Single Plus			42H Double			42H Triple		
	Back Panel Seat and Back Cushions	C	P	S	C	P	S	C	P	S	C	P	S
		2.2 yds	2.2	2.2	3.0	3.0	3.0	2.5	2.5	2.5	3.3	3.3	3.3
		2.8 yds	2.2	2.2	3.6	3.0	3.0	5.2	4.1	4.1	7.7	6.1	6.1

5. Power

<input type="radio"/>	<input checked="" type="radio"/>
Power	Refer to under mount power ordering steps on page 12.

6. Upholstery

<input type="radio"/>	<input checked="" type="radio"/>
Upholstery	See <u>general information section</u> for details on textile program and COM/ COL information.
	Yardages provided are for fabrics cut railroaded. While that is generally our preference for Free Address, there may be exceptions if we decide that up the roll is more visually pleasing. If COM fabrics are to be cut up the roll, please contact customer service. Select highest grade in the case of dual upholstery.

Free Address

SEATS: 42H BANQUETTE CORNER

*Height when mounted on a frame.

Textile Upholstery Grades

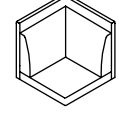
TITLE		SERIES	MODEL	SEAM	PANELS	DIMENSIONS	YDG	COM	A	B	C	D	E	F	G	H	I	J	K	L	M
Seat, 42H Banquette, Corner 	Casual Seam	FA	34	C	BQ	30W x 30D x 42.5H	5.2	3,573	3,961	4,175	4,383	4,596	4,809	5,041	5,273	5,548	5,900	6,327	6,749	7,175	7,595
	Pinch Seam	FA	34	P	BQ	30W x 30D x 42.5H	5	3,623	3,993	4,193	4,390	4,593	4,794	5,015	5,234	5,496	5,828	6,233	6,631	7,035	7,433
	Standard Seam	FA	34	S	BQ	30W x 30D x 42.5H	5	3,623	3,993	4,193	4,390	4,593	4,794	5,015	5,234	5,496	5,828	6,233	6,631	7,035	7,433

To Order Select Below

1. Series/Model

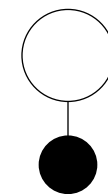

FA34

**Free Address
Seat, 42H, Corner**

2. Upholstery Style

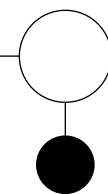

Upholstery Style

C CASUAL

P PINCH

S STANDARD

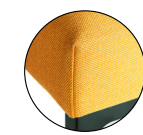

Casual

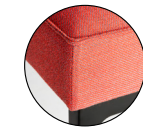

Pinch

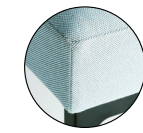

Standard

3. Banquette

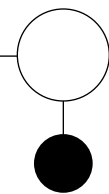

Banquette

BQ BANQUETTE

4. Dual Upholstery

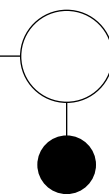

Dual Upholstery

DF1 DUAL UPHOLSTERY STYLE 1

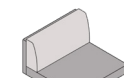
 Seat Cushion and Back Panel
Back Cushion

DF2 DUAL UPHOLSTERY STYLE 2

 Back Panel
Seat and Back Cushions

42H Corner

C P S

3.6 yds 3.3 3.3
2.2 yds 2.2 2.2

C P S

2.5 yds 2.5 2.5
3.0 yds 2.8 2.8

5. Upholstery

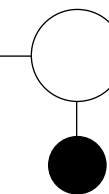

Upholstery

See general information section for details on textile program and COM/COL information.

Yardages provided are for fabrics cut railroaded. While that is generally our preference for Free Address, there may be exceptions if we decide that up the roll is more visually pleasing. If COM fabrics are to be cut up the roll, please contact customer service. Select highest grade in the case of dual upholstery.

Free Address

SEATS: 42H BANQUETTE, END PANEL LEFT/RIGHT

*Height when mounted on a frame.

Textile Upholstery Grades

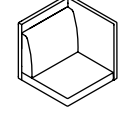
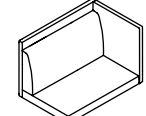
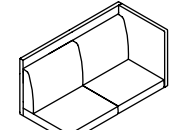
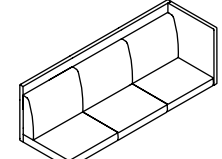
TITLE		SERIES	MODEL	SEAM	PANELS	DIMENSIONS	YDG	COM	A	B	C	D	E	F	G	H	I	J	K	L	M
Seat, 42H Banquette, Single End Panel Left or Right 	Casual Seam	FA	31	C	BQE42L/R	30W x 30D x 42.5H	6.1	3,139	3,588	3,836	4,076	4,322	4,570	4,839	5,106	5,428	5,833	6,327	6,814	7,309	7,796
	Pinch Seam	FA	31	P	BQE42L/R	30W x 30D x 42.5H	5.8	3,259	3,690	3,926	4,155	4,391	4,627	4,883	5,140	5,443	5,833	6,304	6,768	7,240	7,705
	Standard Seam	FA	31	S	BQE42L/R	30W x 30D x 42.5H	5.8	3,259	3,690	3,926	4,155	4,391	4,627	4,883	5,140	5,443	5,833	6,304	6,768	7,240	7,705
Seat, 42H Banquette, Single Plus End Panel Left or Right 	Casual Seam	FA	315	C	BQE42L/R	45W x 30D x 42.5H	7.2	3,538	4,071	4,363	4,647	4,938	5,231	5,547	5,866	6,244	6,724	7,308	7,883	8,467	9,042
	Pinch Seam	FA	315	P	BQE42L/R	45W x 30D x 42.5H	6.6	3,633	4,126	4,394	4,656	4,925	5,195	5,488	5,781	6,131	6,574	7,113	7,643	8,183	8,714
	Standard Seam	FA	315	S	BQE42L/R	45W x 30D x 42.5H	6.6	3,633	4,126	4,394	4,656	4,925	5,195	5,488	5,781	6,131	6,574	7,113	7,643	8,183	8,714
Seat, 42H Banquette, Double End Panel Left or Right 	Casual Seam	FA	32	C	BQE42L/R	60W x 30D x 42.5H	9.1	4,770	5,445	5,817	6,177	6,548	6,918	7,322	7,724	8,204	8,814	9,556	10,286	11,026	11,755
	Pinch Seam	FA	32	P	BQE42L/R	60W x 30D x 42.5H	8.3	4,923	5,539	5,876	6,203	6,540	6,875	7,243	7,609	8,044	8,600	9,274	9,937	10,611	11,275
	Standard Seam	FA	32	S	BQE42L/R	60W x 30D x 42.5H	8.3	4,923	5,539	5,876	6,203	6,540	6,875	7,243	7,609	8,044	8,600	9,274	9,937	10,611	11,275
Seat, 42H Banquette, Triple End Panel Left or Right 	Casual Seam	FA	33	C	BQE42L/R	90W x 30D x 42.5H	12.4	6,352	7,273	7,779	8,269	8,774	9,279	9,829	10,379	11,032	11,865	12,875	13,872	14,880	15,878
	Pinch Seam	FA	33	P	BQE42L/R	90W x 30D x 42.5H	11	6,580	7,400	7,848	8,285	8,733	9,182	9,672	10,160	10,742	11,482	12,380	13,264	14,164	15,048
	Standard Seam	FA	33	S	BQE42L/R	90W x 30D x 42.5H	11	6,580	7,400	7,848	8,285	8,733	9,182	9,672	10,160	10,742	11,482	12,380	13,264	14,164	15,048

To Order Select Below

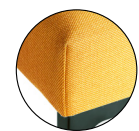
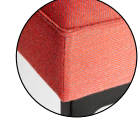
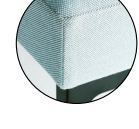
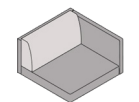
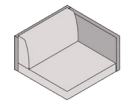
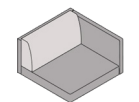
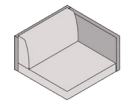
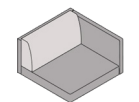
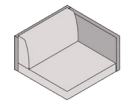
<p>1. Series/Model</p> <p>FA31 Free Address Seat, 42H, Single</p> <p>FA315 Free Address Seat, 42H, Single Plus</p> <p>FA32 Free Address Seat, 42H, Double</p> <p>FA33 Free Address Seat, 42H, Triple</p>	<p>2. Upholstery Style</p> <p>C CASUAL P PINCH S STANDARD</p>  Casual  Pinch  Standard	<p>3. Banquette</p> <p>BQ BANQUETTE</p>	<p>4. End Panel</p> <p>E42L 42H END PANEL LEFT E42R 42H END PANEL RIGHT</p>	<p>5. Dual Upholstery</p> <table border="1"> <thead> <tr> <th rowspan="2">Dual Upholstery</th> <th colspan="3">42H Single</th> <th colspan="3">42H Single Plus</th> <th colspan="3">42H Double</th> <th colspan="3">42H Triple</th> </tr> <tr> <th>C</th> <th>P</th> <th>S</th> <th>C</th> <th>P</th> <th>S</th> <th>C</th> <th>P</th> <th>S</th> <th>C</th> <th>P</th> <th>S</th> </tr> </thead> <tbody> <tr> <td>DF1 DUAL UPHOLSTERY STYLE 1  Seat Cushion, Back Panel, and End Panel Back Cushion</td> <td>5.2 yds</td> <td>5.0</td> <td>4.7</td> <td>5.8</td> <td>5.2</td> <td>5.2</td> <td>7.2</td> <td>6.3</td> <td>6.3</td> <td>9.4</td> <td>10.5</td> <td>8.3</td> </tr> <tr> <td></td> <td>1.4 yds</td> <td>1.4</td> <td>1.4</td> <td>1.7</td> <td>1.7</td> <td>1.7</td> <td>2.5</td> <td>2.5</td> <td>2.5</td> <td>3.9</td> <td>3.9</td> <td>3.9</td> </tr> <tr> <td>DF2 DUAL UPHOLSTERY STYLE 2  Back Panel and End Panel Seat and Back Cushions</td> <td>3.9 yds</td> <td>3.9</td> <td>3.9</td> <td>3.9</td> <td>3.9</td> <td>3.9</td> <td>4.4</td> <td>4.4</td> <td>4.4</td> <td>5.5</td> <td>5.5</td> <td>5.5</td> </tr> <tr> <td></td> <td>2.5 yds</td> <td>2.2</td> <td>2.2</td> <td>3.6</td> <td>2.8</td> <td>2.8</td> <td>5.0</td> <td>4.1</td> <td>4.1</td> <td>7.7</td> <td>6.1</td> <td>6.1</td> </tr> </tbody> </table>	Dual Upholstery	42H Single			42H Single Plus			42H Double			42H Triple			C	P	S	C	P	S	C	P	S	C	P	S	DF1 DUAL UPHOLSTERY STYLE 1  Seat Cushion, Back Panel, and End Panel Back Cushion	5.2 yds	5.0	4.7	5.8	5.2	5.2	7.2	6.3	6.3	9.4	10.5	8.3		1.4 yds	1.4	1.4	1.7	1.7	1.7	2.5	2.5	2.5	3.9	3.9	3.9	DF2 DUAL UPHOLSTERY STYLE 2  Back Panel and End Panel Seat and Back Cushions	3.9 yds	3.9	3.9	3.9	3.9	3.9	4.4	4.4	4.4	5.5	5.5	5.5		2.5 yds	2.2	2.2	3.6	2.8	2.8	5.0	4.1	4.1	7.7	6.1	6.1	<p>6. Power</p> <p>Refer to under mount power ordering steps on page 12.</p>	<p>7. Upholstery</p> <p>See general information section for details on textile program and COM/ COL information.</p> <p>Yardages provided are for fabrics cut railroaded. While that is generally our preference for Free Address, there may be exceptions if we decide that up the roll is more visually pleasing. If COM fabrics are to be cut up the roll, please contact customer service. Select highest grade in the case of dual upholstery.</p>
Dual Upholstery	42H Single			42H Single Plus			42H Double			42H Triple																																																																									
	C	P	S	C	P	S	C	P	S	C	P	S																																																																							
DF1 DUAL UPHOLSTERY STYLE 1  Seat Cushion, Back Panel, and End Panel Back Cushion	5.2 yds	5.0	4.7	5.8	5.2	5.2	7.2	6.3	6.3	9.4	10.5	8.3																																																																							
	1.4 yds	1.4	1.4	1.7	1.7	1.7	2.5	2.5	2.5	3.9	3.9	3.9																																																																							
DF2 DUAL UPHOLSTERY STYLE 2  Back Panel and End Panel Seat and Back Cushions	3.9 yds	3.9	3.9	3.9	3.9	3.9	4.4	4.4	4.4	5.5	5.5	5.5																																																																							
	2.5 yds	2.2	2.2	3.6	2.8	2.8	5.0	4.1	4.1	7.7	6.1	6.1																																																																							

Free Address

SEATS: 42H BANQUETTE, END PANEL BOTH

*Height when mounted on a frame.

Textile Upholstery Grades

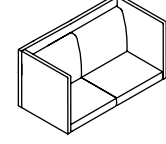
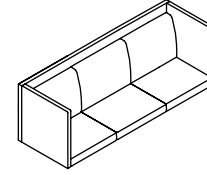
TITLE		SERIES	MODEL	SEAM	PANELS	DIMENSIONS	YDG	COM	A	B	C	D	E	F	G	H	I	J	K	L	M
Seat, 42H Banquette, Double End Panel Both 	Casual Seam	FA	32	C	BQE42B	60W x 30D x 42.5H	11	5,308	6,129	6,576	7,013	7,462	7,911	8,400	8,888	9,469	10,208	11,107	11,991	12,890	13,775
	Pinch Seam	FA	32	P	BQE42B	60W x 30D x 42.5H	10.2	5,460	6,218	6,634	7,037	7,453	7,868	8,319	8,772	9,308	9,994	10,824	11,643	12,474	13,293
	Standard Seam	FA	32	S	BQE42B	60W x 30D x 42.5H	10.2	5,460	6,218	6,634	7,037	7,453	7,868	8,319	8,772	9,308	9,994	10,824	11,643	12,474	13,293
Seat, 42H Banquette, Triple End Panel Both 	Casual Seam	FA	33	C	BQE42B	90W x 30D x 42.5H	14.3	7,005	8,070	8,654	9,222	9,805	10,390	11,025	11,659	12,414	13,375	14,544	15,696	16,863	18,013
	Pinch Seam	FA	33	P	BQE42B	90W x 30D x 42.5H	12.9	7,234	8,196	8,726	9,237	9,764	10,292	10,867	11,441	12,123	12,993	14,047	15,087	16,143	17,184
	Standard Seam	FA	33	S	BQE42B	90W x 30D x 42.5H	12.9	7,234	8,196	8,726	9,237	9,764	10,292	10,867	11,441	12,123	12,993	14,047	15,087	16,143	17,184

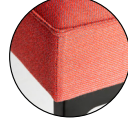
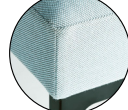
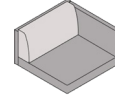
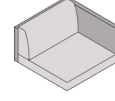
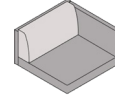
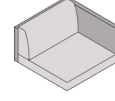
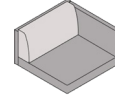
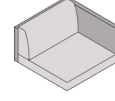

To Order Select Below

<p>1. Series/Model</p> <p>○</p> <p>●</p> <hr/> <p>FA32</p> <hr/> <p>Free Address Seat, 42H, Double</p> <hr/> <p>FA33</p> <hr/> <p>Free Address Seat, 42H, Triple</p>	<p>2. Upholstery Style</p> <p>○</p> <p>● Upholstery Style</p> <hr/> <p>C CASUAL</p> <hr/> <p>P PINCH</p> <hr/> <p>S STANDARD</p> <hr/> <p> Casual</p> <p> Pinch</p> <p> Standard</p>	<p>3. Banquette</p> <p>○</p> <p>● Banquette</p> <hr/> <p>BQ BANQUETTE</p>	<p>4. End Panel</p> <p>○</p> <p>● End Panel</p> <hr/> <p>E42B 42H END PANEL BOTH</p>	<p>5. Dual Upholstery</p> <p>○</p> <p>● Dual Upholstery</p> <table border="1"> <thead> <tr> <th></th> <th colspan="3">42H Double</th> <th colspan="3">42H Triple</th> </tr> <tr> <th></th> <th>C</th> <th>P</th> <th>S</th> <th>C</th> <th>P</th> <th>S</th> </tr> </thead> <tbody> <tr> <td>DF1 DUAL UPHOLSTERY STYLE 1</td> <td></td> <td></td> <td></td> <td></td> <td></td> <td></td> </tr> <tr> <td> Seat Cushion, Back Panel, and End Panels</td> <td>9.1 yds</td> <td>8.3</td> <td>8.3</td> <td>11.3</td> <td>10.2</td> <td>10.2</td> </tr> <tr> <td>Back Cushion</td> <td>2.5 yds</td> <td>2.5</td> <td>2.5</td> <td>3.6</td> <td>3.6</td> <td>3.6</td> </tr> <tr> <td>DF2 DUAL UPHOLSTERY STYLE 2</td> <td></td> <td></td> <td></td> <td></td> <td></td> <td></td> </tr> <tr> <td> Back Panel and End Panels</td> <td>6.6 yds</td> <td>6.6</td> <td>6.6</td> <td>7.4</td> <td>7.4</td> <td>7.4</td> </tr> <tr> <td>Seat and Back Cushions</td> <td>5.0 yds</td> <td>3.9</td> <td>3.9</td> <td>7.4</td> <td>5.8</td> <td>5.8</td> </tr> </tbody> </table>		42H Double			42H Triple				C	P	S	C	P	S	DF1 DUAL UPHOLSTERY STYLE 1							 Seat Cushion, Back Panel, and End Panels	9.1 yds	8.3	8.3	11.3	10.2	10.2	Back Cushion	2.5 yds	2.5	2.5	3.6	3.6	3.6	DF2 DUAL UPHOLSTERY STYLE 2							 Back Panel and End Panels	6.6 yds	6.6	6.6	7.4	7.4	7.4	Seat and Back Cushions	5.0 yds	3.9	3.9	7.4	5.8	5.8	<p>6. Power</p> <p>○</p> <p>● Power</p> <p>Refer to under mount power ordering steps on page 12.</p>	<p>7. Upholstery</p> <p>○</p> <p>● Upholstery</p> <p>See general information section for details on textile program and COM/COL information.</p> <p>Yardages provided are for fabrics cut railroaded. While that is generally our preference for Free Address, there may be exceptions if we decide that up the roll is more visually pleasing. If COM fabrics are to be cut up the roll, please contact customer service. Select highest grade in the case of dual upholstery.</p>
	42H Double			42H Triple																																																										
	C	P	S	C	P	S																																																								
DF1 DUAL UPHOLSTERY STYLE 1																																																														
 Seat Cushion, Back Panel, and End Panels	9.1 yds	8.3	8.3	11.3	10.2	10.2																																																								
Back Cushion	2.5 yds	2.5	2.5	3.6	3.6	3.6																																																								
DF2 DUAL UPHOLSTERY STYLE 2																																																														
 Back Panel and End Panels	6.6 yds	6.6	6.6	7.4	7.4	7.4																																																								
Seat and Back Cushions	5.0 yds	3.9	3.9	7.4	5.8	5.8																																																								

Free Address

ARMS: TASK

Textile Upholstery Grades

TITLE	SERIES	MODEL	SEAM	PANELS	DIMENSIONS	YDG	COM	A	B	C	D	E	F	G	H	I	J	K	L	M
Arm, 2 Inch 	FA	42	-	-	2W x 30D x 26H	1.7	409	530	598	664	732	799	872	944	1,032	1,143	1,279	1,411	1,545	1,679
Arm, 4 Inch 	FA	44	-	-	4W x 30D x 26H	1.7	414	537	604	669	736	805	878	951	1,038	1,149	1,283	1,416	1,551	1,683
Arm, 6 Inch 	FA	46	-	-	6W x 30D x 26H	1.7	419	543	609	676	743	810	883	957	1,044	1,154	1,291	1,422	1,557	1,690

To Order Select Below

1. Series/Model

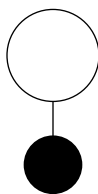

FA42

**Free Address
Arm, 2 Inch**

FA44

**Free Address
Arm, 4 Inch**

FA46

**Free Address
Arm, 6 Inch**

2. Upholstery

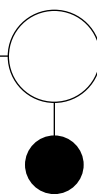

Upholstery







See general information section for details on textile program and COM/COL information.

Yardages provided are for fabrics cut railroaded. While that is generally our preference for Free Address, there may be exceptions if we decide that up the roll is more visually pleasing. If COM fabrics are to be cut up the roll, please contact customer service. Select highest grade in the case of dual upholstery.

Free Address

TABLE TOPS: SEAT HEIGHT, 15D

*Height when mounted on a frame.

TITLE	SERIES	MODEL	SIZE	DIMENSIONS	LM1	LM2	WV1
Table Top, 15D x 15W 	FA	5S	1515	15W x 15D	268	343	342
Table Top, 15D x 30W 	FA	5S	1530	30W x 15D	354	413	538
Table Top, 15D x 45W 	FA	5S	1545	45W x 15D	485	586	795
Table Top, 15D x 60W 	FA	5S	1560	60W x 15D	579	795	1,061
Table Top, 15D x 75W 	FA	5S	1575	75W x 15D	752	967	1,317
Table Top, 15D x 90W 	FA	5S	1590	90W x 15D	799	1,138	1,520

To Order Select Below

1. Series/Model

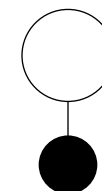

FA5S

**Free Address
Table Top, Seat Height**

2. Size

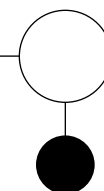

15" Deep

1515	15 X 15
1530	15 X 30
1545	15 X 45
1560	15 X 60
1575	15 X 75
1590	15 X 90

3. Top Finish

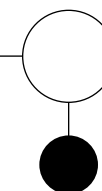

Laminate Grade 1

LM01	DESIGNER WHITE
LM02	ALABASTER
LM03	WALLABY
LM04	SHADOW
LM05	DOVE GRAY
LM06	FASHION GRAY
LM07	SLATE GRAY
LM08	NORTH SEA
LM09	BLACK

Laminate Grade 2

LM10	FUSION MAPLE
LM11	MONTICELLO MAPLE
LM12	RIVER CHERRY
LM13	AMBER CHERRY
LM14	WALNUT HEIGHTS
LM15	MONTANA WALNUT
LM16	XANADU
LM17	ASIAN NIGHT
LM18	CASTLE OAK

Laminate wood pattern always runs in the length dimension.

Veneer



LM41	BIANCO KOS
LM42	GRIGIO EFESO
LM43	GRIGIO LONDRA
LM44	GRIGIO BROMO
LM45	NERO INGO

Custom Top Finish

LM99	CUSTOM LAMINATE
WV99	CUSTOM WOOD VENEER

Refer to [page 10](#) for custom top details.

4. Power

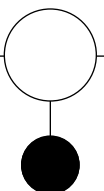

Power

Refer to under mount power ordering steps on [page 12](#).





WV43	TONED WENGE
WV44	TONED OAK
WV45	TONED RECON OAK
WV46	NATURAL FLAT CUT WALNUT
WV47	NATURAL RIFT CUT WALNUT
WV48	NATURAL WHITE OAK
WV49	NATURAL RECON WHITE OAK

Wood veneer grain direction always runs in the length dimension.

Free Address

TABLE TOPS: SEAT HEIGHT, 30D AND 45D

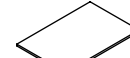
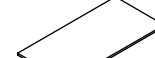
*Height when mounted on a frame.

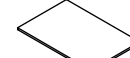
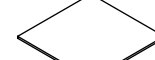
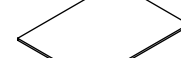
TITLE	SERIES	MODEL	SIZE	DIMENSIONS	LM1	LM2	WV1
Table Top, 30D x 15W 	FA	5S	3015	15W x 30D	355	411	540
Table Top, 30D x 30W 	FA	5S	3030	30W x 30D	597	725	1,013
Table Top, 30D x 45W 	FA	5S	3045	45W x 30D	843	1,030	1,481
Table Top, 30D x 60W 	FA	5S	3060	60W x 30D	1,014	1,380	1,949
Table Top, 45D x 15W 	FA	5S	4515	15W x 45D	486	586	795
Table Top, 45D x 30W 	FA	5S	4530	30W x 45D	844	1,029	1,481
Table Top, 45D x 45W 	FA	5S	4545	45W x 45D	1,069	1,442	2,153
Table Top, 45D x 60W 	FA	5S	4560	60W x 45D	1,278	1,872	2,861

To Order Select Below

1. Series/Model

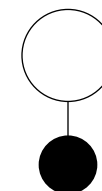

FA5S

Free Address
Table Top, Seat Height

2. Size

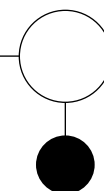

30" Deep

3015	30 X 15
3030	30 X 30
3045	30 X 45
3060	30 X 60

45" Deep

4515	45 X 15
4530	45 X 30
4545	45 X 45
4560	45 X 60

3. Top Finish

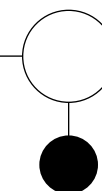

Laminate Grade 1

LM01	DESIGNER WHITE
LM02	ALABASTER
LM03	WALLABY
LM04	SHADOW
LM05	DOVE GRAY
LM06	FASHION GRAY
LM07	SLATE GRAY
LM08	NORTH SEA
LM09	BLACK

LM10	FUSION MAPLE
LM11	MONTICELLO MAPLE
LM12	RIVER CHERRY
LM13	AMBER CHERRY
LM14	WALNUT HEIGHTS
LM15	MONTANA WALNUT
LM16	XANADU
LM17	ASIAN NIGHT
LM18	CASTLE OAK

Laminate wood pattern always runs in the length dimension.

Laminate Grade 2



LM41	BIANCO KOS
LM42	GRIGIO EFESO
LM43	GRIGIO LONDRA
LM44	GRIGIO BROMO
LM45	NERO INGO

Custom Top Finish

LM99	CUSTOM LAMINATE
WV99	CUSTOM WOOD VENEER

Refer to [page 10](#) for custom top details.

Veneer



WV01	LIGHT GRAY
WV02	WARM GRAY
WV03	OPAQUE BLACK
WV04	MEDIUM CHERRY
WV05	TONED ASH
WV06	NATURAL MAPLE
WV41	TONED RECON WALNUT
WV42	DARK TONED OAK

4. Power

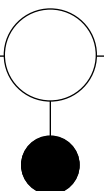

Power

Refer to under mount power ordering steps on [page 12](#).

WV43	TONED WENGE
WV44	TONED OAK
WV45	TONED RECON OAK
WV46	NATURAL FLAT CUT WALNUT
WV47	NATURAL RIFT CUT WALNUT
WV48	NATURAL WHITE OAK
WV49	NATURAL RECON WHITE OAK

Wood veneer grain direction always runs in the length dimension.

Free Address

TABLE TOPS: LEDGE HEIGHT, 15D

*Height when mounted on a frame.

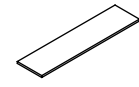
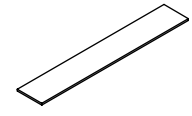
TITLE	SERIES	MODEL	SIZE	DIMENSIONS	LM1	LM2	WV1
Ledge Top, 15D x 30W 	FA	5L	1530	30W x 15D	354	413	538
Ledge Top, 15D x 60W 	FA	5L	1560	60W x 15D	579	795	1,061
Ledge Top, 15D x 90W 	FA	5L	1590	90W x 15D	799	1,138	1,520

To Order Select Below

1. Series/Model

○

●

FA5L

**Free Address
Table Top, Ledge Height**

2. Size

○

● **15" Deep**

1530	15 X 30
1560	15 X 60
1590	15 X 90

3. Top Finish

○

● **Laminate Grade 1**

LM01	DESIGNER WHITE
LM02	ALABASTER
LM03	WALLABY
LM04	SHADOW
LM05	DOVE GRAY
LM06	FASHION GRAY
LM07	SLATE GRAY
LM08	NORTH SEA
LM09	BLACK

LM10 FUSION MAPLE

LM11 MONTICELLO MAPLE

LM12 RIVER CHERRY

LM13 AMBER CHERRY

LM14 WALNUT HEIGHTS

LM15 MONTANA WALNUT

LM16 XANADU

LM17 ASIAN NIGHT

LM18 CASTLE OAK

Laminate wood pattern always runs in the length dimension.

● **Laminate Grade 2**

LM41 BIANCO KOS

LM42 GRIGIO EFESO

LM43 GRIGIO LONDRA

LM44 GRIGIO BROMO

LM45 NERO INGO

● **Custom Top Finish**

LM99 CUSTOM LAMINATE

WV99 CUSTOM WOOD VENEER

Refer to [page 10](#) for custom top details.

● **Veneer**

WV01 LIGHT GRAY

WV02 WARM GRAY

WV03 OPAQUE BLACK

WV04 MEDIUM CHERRY

WV05 TONED ASH

WV06 NATURAL MAPLE

WV41 TONED RECON WALNUT

WV42 DARK TONED OAK

○

● **Power**

WV43 TONED WENGE

WV44 TONED OAK

WV45 TONED RECON OAK

WV46 NATURAL FLAT CUT WALNUT

WV47 NATURAL RIFT CUT WALNUT

WV48 NATURAL WHITE OAK

WV49 NATURAL RECON WHITE OAK









Wood veneer grain direction always runs in the length dimension.

Refer to under mount power ordering steps on page 12.

Free Address

CASE GOODS: CUBBY

*Height when mounted on a frame.

TITLE	SERIES	MODEL	SIZE	DIMENSIONS	LM1	LM2	WV1
Case Good, Cubby 29H, 15W Single 	FA	6C	1H29	15W x 15D x 29H	1,477	2,949	3,047
Case Good, Cubby 36H, 15W Single 	FA	6C	1H36	15W x 15D x 36H	2,051	4,145	3,649
Case Good, Cubby 42H, 15W Single 	FA	6C	1H42	15W x 15D x 42H	2,321	4,736	4,169
Case Good, Cubby 29H, 30W Double 	FA	6C	2H29	30W x 15D x 29H	1,886	3,346	3,225
Case Good, Cubby 36H, 30W Double 	FA	6C	2H36	30W x 15D x 36H	2,861	4,865	4,282
Case Good, Cubby 42H, 30W Double 	FA	6C	2H42	30W x 15D x 42H	3,022	5,250	4,621
Case Good, Cubby 29H, 45W Triple 	FA	6C	3H29	45W x 15D x 29H	2,361	3,799	3,629
Case Good, Cubby 29H, 60W Quad 	FA	6C	4H29	60W x 15D x 29H	2,922	4,627	4,060

To Order Select Below

1. Series/Model

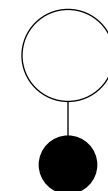

FA6C

Free Address Case Good, Cubby

2. Size

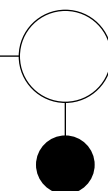

Single

1H29 15 X 29

1H36 15 X 36

1H42 15 X 42

Double

2H29 30 X 29

2H36 30 X 36

2H42 30 X 42

Triple/Quad

3H29 45 X 29

4H29 60 X 29

3. Top Finish

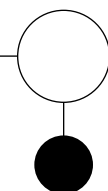

Laminate Grade 1

LM01 DESIGNER WHITE

LM02 ALABASTER

LM03 WALLABY

LM04 SHADOW

LM05 DOVE GRAY

LM06 FASHION GRAY

LM07 SLATE GRAY

LM08 NORTH SEA

LM09 BLACK

LM10 FUSION MAPLE

LM11 MONTICELLO MAPLE

LM12 RIVER CHERRY

LM13 AMBER CHERRY

LM14 WALNUT HEIGHTS

LM15 MONTANA WALNUT

LM16 XANADU

LM17 ASIAN NIGHT

LM18 CASTLE OAK

Laminate wood pattern always runs in the length dimension.

Laminate Grade 2



LM41 BIANCO KOS

LM42 GRIGIO EFESO

LM43 GRIGIO LONDRA

LM44 GRIGIO BROMO

LM45 NERO INGO

Custom Top Finish

LM99 CUSTOM LAMINATE

WV99 CUSTOM WOOD VENEER

Refer to [page 10](#) for custom top details.

Veneer



WV01 LIGHT GRAY

WV02 WARM GRAY

WV03 OPAQUE BLACK

WV04 MEDIUM CHERRY

WV05 TONED ASH

WV06 NATURAL MAPLE

WV41 TONED RECON WALNUT

WV42 DARK TONED OAK

WV43 TONED WENGE

WV44 TONED OAK

WV45 TONED RECON OAK

WV46 NATURAL FLAT CUT WALNUT

WV47 NATURAL RIFT CUT WALNUT

WV48 NATURAL WHITE OAK

WV49 NATURAL RECON WHITE OAK

Wood veneer grain direction always runs in the length dimension.

4. Grain Direction

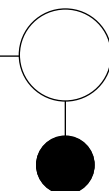

Grain Direction

FB FRONT/BACK

Left/Right is standard and is automatically applied if Front/Back is not specified.

Effective 5/15/2023, lockers, cubbies and shelves in Grade 1 laminate utilize butt-joint construction. Refer to page 21 for details. If the backs of any lockers, cubbies, and shelves will be exposed, we recommend utilizing mitered construction by specifying Grade 2 laminate, wood veneer, or a custom solution.

Free Address

CASE GOODS: CUBBY COMBO

*Height when mounted on a frame.

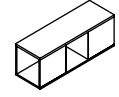
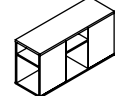
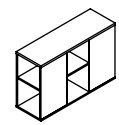
TITLE	SERIES	MODEL	SIZE	DIMENSIONS	LM1	LM2	WV1
Case Good Cubby Combo, 29H 	FA	6C	XH29	45W x 15D x 29H	2,655	5,675	5,376
Case Good Cubby Combo, 36H 	FA	6C	XH36	45W x 15D x 36H	3,904	5,918	5,596
Case Good Cubby Combo, 42H 	FA	6C	XH42	45W x 15D x 42H	4,154	6,290	5,952

To Order Select Below

1. Series/Model

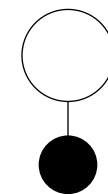

FA6C

Free Address Case Good, Cubby

2. Size

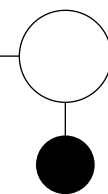

Combo

XH29 45 X 29

XH36 45 X 36

XH42 45 X 42

3. Top Finish

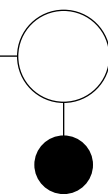

Laminate Grade 1

LM01 DESIGNER WHITE

LM02 ALABASTER

LM03 WALLABY

LM04 SHADOW

LM05 DOVE GRAY

LM06 FASHION GRAY

LM07 SLATE GRAY

LM08 NORTH SEA

LM09 BLACK

LM10 FUSION MAPLE

LM11 MONTICELLO MAPLE

LM12 RIVER CHERRY

LM13 AMBER CHERRY

LM14 WALNUT HEIGHTS

LM15 MONTANA WALNUT

LM16 XANADU

LM17 ASIAN NIGHT

LM18 CASTLE OAK

Laminate wood pattern always runs in the length dimension.

Laminate Grade 2

LM41 BIANCO KOS

LM42 GRIGIO EFESO

LM43 GRIGIO LONDRA

LM44 GRIGIO BROMO

LM45 NERO INGO

Custom Top Finish

LM99 CUSTOM LAMINATE

WV99 CUSTOM WOOD VENEER

Refer to [page 10](#) for custom top details.

Veneer

WV01 LIGHT GRAY

WV02 WARM GRAY

WV03 OPAQUE BLACK

WV04 MEDIUM CHERRY

WV05 TONED ASH

WV06 NATURAL MAPLE

WV41 TONED RECON WALNUT

WV42 DARK TONED OAK

WV43 TONED WENGE

WV44 TONED OAK

WV45 TONED RECON OAK

WV46 NATURAL FLAT CUT WALNUT

WV47 NATURAL RIFT CUT WALNUT

WV48 NATURAL WHITE OAK

WV49 NATURAL RECON WHITE OAK

Wood veneer grain direction always runs in the length dimension.

4. Grain Direction

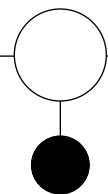

Grain Direction









FB FRONT/BACK

Left/Right is standard and is automatically applied if Front/Back is not specified.

Free Address

CASE GOODS: LOCKER

*Height when mounted on a frame.

TITLE		SERIES	MODEL	SIZE	DIMENSIONS	LM1	LM2	WV1
Case Good, Locker 29H, 15W Single		FA	6L	1H29	15W x 15D x 29H	1,831	3,402	3,733
Case Good, Locker 36H, 15W Single		FA	6L	1H36	15W x 15D x 36H	2,414	3,869	4,186
Case Good, Locker 42H, 15W Single		FA	6L	1H42	15W x 15D x 42H	2,721	4,420	4,791
Case Good, Locker 29H, 30W Double		FA	6L	2H29	30W x 15D x 29H	2,594	4,557	4,098
Case Good, Locker 36H, 30W Double		FA	6L	2H36	30W x 15D x 36H	3,276	4,203	4,550
Case Good, Locker 42H, 30W Double		FA	6L	2H42	30W x 15D x 42H	3,730	4,802	5,203
Case Good, Locker 29H, 45W Triple		FA	6L	3H29	45W x 15D x 29H	3,430	5,680	4,735
Case Good, Locker 29H, 60W Quad		FA	6L	4H29	60W x 15D x 29H	4,344	6,905	5,118

To Order Select Below

<p>1. Series/Model</p> <p>FA6L</p> <p>Free Address Case Good, Locker</p> <p>Effective 5/15/2023, lockers, cubbies and shelves in Grade 1 laminate utilize butt-joint construction. Refer to page 21 for details. If the backs of any lockers, cubbies, and shelves will be exposed, we recommend utilizing mitered construction by specifying Grade 2 laminate, wood veneer, or a custom solution.</p>	<p>2. Size</p> <p>Single</p> <p>1H29 15 X 29 1H36 15 X 36 1H42 15 X 42</p> <p>Double</p> <p>2H29 30 X 29 2H36 30 X 36 2H42 30 X 42</p> <p>Triple/Quad</p> <p>3H29 45 X 29 4H29 60 X 29</p>	<p>3. Top Finish</p> <p>Laminate Grade 1</p> <p>LM01 DESIGNER WHITE LM02 ALABASTER LM03 WALLABY LM04 SHADOW LM05 DOVE GRAY LM06 FASHION GRAY LM07 SLATE GRAY LM08 NORTH SEA LM09 BLACK</p> <p>Laminate Grade 2</p> <p>LM10 FUSION MAPLE LM11 MONTICELLO MAPLE LM12 RIVER CHERRY LM13 AMBER CHERRY LM14 WALNUT HEIGHTS LM15 MONTANA WALNUT LM16 XANADU LM17 ASIAN NIGHT LM18 CASTLE OAK</p> <p>Laminate wood pattern always runs in the length dimension.</p>	<p>Laminate Grade 2</p> <p>LM41 BIANCO KOS LM42 GRIGIO EFESO LM43 GRIGIO LONDRA LM44 GRIGIO BROMO LM45 NERO INGO</p> <p>Custom Top Finish</p> <p>LM99 CUSTOM LAMINATE WV99 CUSTOM WOOD VENEER</p> <p>Refer to page page 10 for custom top details.</p>	<p>Veneer</p> <p>WV01 LIGHT GRAY WV02 WARM GRAY WV03 OPAQUE BLACK WV04 MEDIUM CHERRY WV05 TONED ASH WV06 NATURAL MAPLE</p> <p>TONED RECON WALNUT WV41 WV42 DARK TONED OAK WV43 TONED WENGE WV44 TONED OAK</p>	<p>TONED RECON OAK</p> <p>WV45</p> <p>NATURAL FLAT CUT WALNUT</p> <p>WV46</p> <p>NATURAL RIFT CUT WALNUT</p> <p>WV47</p> <p>NATURAL WHITE OAK</p> <p>WV48</p> <p>NATURAL RECON WHITE OAK</p> <p>WV49</p> <p>Wood veneer grain direction always runs in the length dimension.</p>	<p>4. Door Hardware</p> <p>Lock</p> <p>PXX* DOOR PULL (NO LOCK) KLB KEY LOCK BLACK +75 /door KLW KEY LOCK WHITE +75 /door NPB NUMBER PAD LOCK BLACK +285 /door NPN NUMBER PAD LOCK NICKEL +285 /door RFB RFID LOCK BLACK +371 /door RFN RFID LOCK NICKEL +371 /door</p> <p>* Replace xx with a standard powder coat paint color listed at the bottom of page 52.</p> <p>* Master keys required per order with locks (see page 16)</p>	<p>5. Options</p> <p>Hinge Left Side</p> <p>HG HINGE LEFT SIDE</p> <p>Default hinge on right side when facing front of locker.</p> <p>Grain Direction</p> <p>FB FRONT/BACK</p> <p>Left/Right is standard and is automatically applied if Front/Back is not specified.</p>
--	--	---	---	--	---	---	--

Free Address

CASE GOODS: LOCKER COMBO

*Height when mounted on a frame.

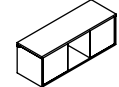
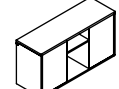
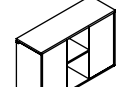
TITLE	SERIES	MODEL	SIZE	DIMENSIONS	LM1	LM2	WV1
Case Good Locker Combo, 29H 	FA	6L	XH29	45W x 15D x 29H	3,572	6,290	5,952
Case Good Locker Combo, 36H 	FA	6L	XH36	45W x 15D x 36H	4,748	6,557	6,203
Case Good Locker Combo, 42H 	FA	6L	XH42	45W x 15D x 42H	5,081	6,816	6,446

Left Hinge Options (Step 5) Top View

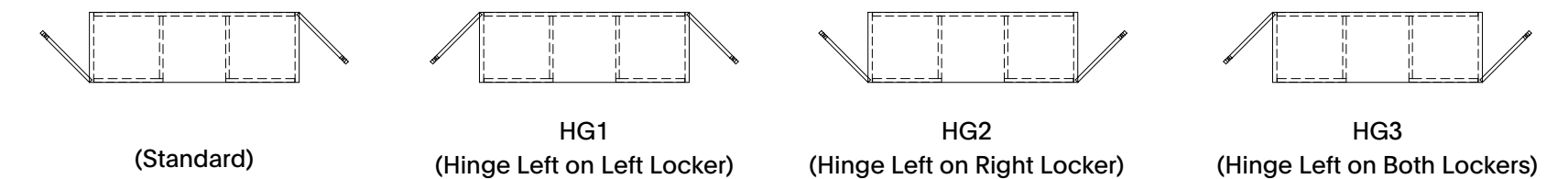









To Order Select Below

<p>1. Series/Model</p> <p>FA6L</p> <p>Free Address Case Good, Locker</p>	<p>2. Size</p> <p>Combo</p> <table border="1"> <tr><td>XH29</td><td>45 X 29</td></tr> <tr><td>XH36</td><td>45 X 36</td></tr> <tr><td>XH42</td><td>45 X 42</td></tr> </table>	XH29	45 X 29	XH36	45 X 36	XH42	45 X 42	<p>3. Top Finish</p> <p>Laminate Grade 1</p> <table border="1"> <tr><td>LM01</td><td>DESIGNER WHITE</td></tr> <tr><td>LM02</td><td>ALABASTER</td></tr> <tr><td>LM03</td><td>WALLABY</td></tr> <tr><td>LM04</td><td>SHADOW</td></tr> <tr><td>LM05</td><td>DOVE GRAY</td></tr> <tr><td>LM06</td><td>FASHION GRAY</td></tr> <tr><td>LM07</td><td>SLATE GRAY</td></tr> <tr><td>LM08</td><td>NORTH SEA</td></tr> <tr><td>LM09</td><td>BLACK</td></tr> </table> <p>Laminate Grade 2</p> <table border="1"> <tr><td>LM10</td><td>FUSION MAPLE</td></tr> <tr><td>LM11</td><td>MONTICELLO MAPLE</td></tr> <tr><td>LM12</td><td>RIVER CHERRY</td></tr> <tr><td>LM13</td><td>AMBER CHERRY</td></tr> <tr><td>LM14</td><td>WALNUT HEIGHTS</td></tr> <tr><td>LM15</td><td>MONTANA WALNUT</td></tr> <tr><td>LM16</td><td>XANADU</td></tr> <tr><td>LM17</td><td>ASIAN NIGHT</td></tr> <tr><td>LM18</td><td>CASTLE OAK</td></tr> </table> <p>Custom Top Finish</p> <table border="1"> <tr><td>LM99</td><td>CUSTOM LAMINATE</td></tr> <tr><td>WV99</td><td>CUSTOM WOOD VENEER</td></tr> </table> <p>Laminate wood pattern always runs in the length dimension.</p> <p>Refer to page page 10 for custom top details.</p>	LM01	DESIGNER WHITE	LM02	ALABASTER	LM03	WALLABY	LM04	SHADOW	LM05	DOVE GRAY	LM06	FASHION GRAY	LM07	SLATE GRAY	LM08	NORTH SEA	LM09	BLACK	LM10	FUSION MAPLE	LM11	MONTICELLO MAPLE	LM12	RIVER CHERRY	LM13	AMBER CHERRY	LM14	WALNUT HEIGHTS	LM15	MONTANA WALNUT	LM16	XANADU	LM17	ASIAN NIGHT	LM18	CASTLE OAK	LM99	CUSTOM LAMINATE	WV99	CUSTOM WOOD VENEER	<p>Veneer</p> <table border="1"> <tr><td>WV01</td><td>LIGHT GRAY</td></tr> <tr><td>WV02</td><td>WARM GRAY</td></tr> <tr><td>WV03</td><td>OPAQUE BLACK</td></tr> <tr><td>WV04</td><td>MEDIUM CHERRY</td></tr> <tr><td>WV05</td><td>TONED ASH</td></tr> <tr><td>WV06</td><td>NATURAL MAPLE</td></tr> <tr><td>WV41</td><td>TONED RECON WALNUT</td></tr> <tr><td>WV42</td><td>DARK TONED OAK</td></tr> <tr><td>WV43</td><td>TONED WENGE</td></tr> <tr><td>WV44</td><td>TONED OAK</td></tr> </table> <p>Wood veneer grain direction always runs in the length dimension.</p>	WV01	LIGHT GRAY	WV02	WARM GRAY	WV03	OPAQUE BLACK	WV04	MEDIUM CHERRY	WV05	TONED ASH	WV06	NATURAL MAPLE	WV41	TONED RECON WALNUT	WV42	DARK TONED OAK	WV43	TONED WENGE	WV44	TONED OAK	<p>4. Door Hardware</p> <p>Lock</p> <table border="1"> <tr><td>WV45</td><td>TONED RECON OAK</td></tr> <tr><td>WV46</td><td>NATURAL FLAT CUT WALNUT</td></tr> <tr><td>WV47</td><td>NATURAL RIFT CUT WALNUT</td></tr> <tr><td>WV48</td><td>NATURAL WHITE OAK</td></tr> <tr><td>WV49</td><td>NATURAL RECON WHITE OAK</td></tr> </table> <p>PXX* DOOR PULL (NO LOCK)</p> <table border="1"> <tr><td>KLB</td><td>KEY LOCK BLACK</td><td>+75 /door</td></tr> <tr><td>KLW</td><td>KEY LOCK WHITE</td><td>+75 /door</td></tr> <tr><td>NPB</td><td>NUMBER PAD LOCK BLACK</td><td>+285 /door</td></tr> <tr><td>NPN</td><td>NUMBER PAD LOCK NICKEL</td><td>+285 /door</td></tr> <tr><td>RFB</td><td>RFID LOCK BLACK</td><td>+371 /door</td></tr> <tr><td>RFN</td><td>RFID LOCK NICKEL</td><td>+371 /door</td></tr> </table> <p>* Replace xx with a standard powder coat paint color listed at the bottom of page 52.</p> <p>* Master keys required per order with locks (see page 16)</p>	WV45	TONED RECON OAK	WV46	NATURAL FLAT CUT WALNUT	WV47	NATURAL RIFT CUT WALNUT	WV48	NATURAL WHITE OAK	WV49	NATURAL RECON WHITE OAK	KLB	KEY LOCK BLACK	+75 /door	KLW	KEY LOCK WHITE	+75 /door	NPB	NUMBER PAD LOCK BLACK	+285 /door	NPN	NUMBER PAD LOCK NICKEL	+285 /door	RFB	RFID LOCK BLACK	+371 /door	RFN	RFID LOCK NICKEL	+371 /door	<p>5. Options</p> <p>Hinge Left Side</p> <table border="1"> <tr><td>HG1</td><td>HLS ON LEFT LOCKER</td></tr> <tr><td>HG2</td><td>HLS ON RIGHT LOCKER</td></tr> <tr><td>HG3</td><td>HLS ON BOTH LOCKERS</td></tr> </table> <p>Default hinge on right side when facing front of locker.</p> <p>Grain Direction</p> <table border="1"> <tr><td>FB</td><td>FRONT/BACK</td></tr> </table> <p>Left/Right is standard and is automatically applied if Front/Back is not specified.</p>	HG1	HLS ON LEFT LOCKER	HG2	HLS ON RIGHT LOCKER	HG3	HLS ON BOTH LOCKERS	FB	FRONT/BACK
XH29	45 X 29																																																																																																										
XH36	45 X 36																																																																																																										
XH42	45 X 42																																																																																																										
LM01	DESIGNER WHITE																																																																																																										
LM02	ALABASTER																																																																																																										
LM03	WALLABY																																																																																																										
LM04	SHADOW																																																																																																										
LM05	DOVE GRAY																																																																																																										
LM06	FASHION GRAY																																																																																																										
LM07	SLATE GRAY																																																																																																										
LM08	NORTH SEA																																																																																																										
LM09	BLACK																																																																																																										
LM10	FUSION MAPLE																																																																																																										
LM11	MONTICELLO MAPLE																																																																																																										
LM12	RIVER CHERRY																																																																																																										
LM13	AMBER CHERRY																																																																																																										
LM14	WALNUT HEIGHTS																																																																																																										
LM15	MONTANA WALNUT																																																																																																										
LM16	XANADU																																																																																																										
LM17	ASIAN NIGHT																																																																																																										
LM18	CASTLE OAK																																																																																																										
LM99	CUSTOM LAMINATE																																																																																																										
WV99	CUSTOM WOOD VENEER																																																																																																										
WV01	LIGHT GRAY																																																																																																										
WV02	WARM GRAY																																																																																																										
WV03	OPAQUE BLACK																																																																																																										
WV04	MEDIUM CHERRY																																																																																																										
WV05	TONED ASH																																																																																																										
WV06	NATURAL MAPLE																																																																																																										
WV41	TONED RECON WALNUT																																																																																																										
WV42	DARK TONED OAK																																																																																																										
WV43	TONED WENGE																																																																																																										
WV44	TONED OAK																																																																																																										
WV45	TONED RECON OAK																																																																																																										
WV46	NATURAL FLAT CUT WALNUT																																																																																																										
WV47	NATURAL RIFT CUT WALNUT																																																																																																										
WV48	NATURAL WHITE OAK																																																																																																										
WV49	NATURAL RECON WHITE OAK																																																																																																										
KLB	KEY LOCK BLACK	+75 /door																																																																																																									
KLW	KEY LOCK WHITE	+75 /door																																																																																																									
NPB	NUMBER PAD LOCK BLACK	+285 /door																																																																																																									
NPN	NUMBER PAD LOCK NICKEL	+285 /door																																																																																																									
RFB	RFID LOCK BLACK	+371 /door																																																																																																									
RFN	RFID LOCK NICKEL	+371 /door																																																																																																									
HG1	HLS ON LEFT LOCKER																																																																																																										
HG2	HLS ON RIGHT LOCKER																																																																																																										
HG3	HLS ON BOTH LOCKERS																																																																																																										
FB	FRONT/BACK																																																																																																										

Free Address

CASE GOODS: PLANTER

*Height when mounted on a frame. Stylex will not be responsible for damage caused by improper use of planter liner.

TITLE	SERIES	MODEL	SIZE	DIMENSIONS	LM1	LM2	WV1
Case Good, Planter 29H, 15W Single 	FA	6P	1H29	15W x 15D x 29H	1,506	2,917	2,885
Case Good, Planter 36in Height, 15W Single 	FA	6P	1H36	15W x 15D x 36H	1,837	3,169	3,138
Case Good, Planter 42in Height, 15W Single 	FA	6P	1H42	15W x 15D x 42H	1,929	3,389	3,358
Case Good, Planter 29H, 30W Double 	FA	6P	2H29	30W x 15D x 29H	2,734	3,561	3,528
Case Good, Planter 36in Height, 30W Double 	FA	6P	2H36	30W x 15D x 36H	2,927	4,118	3,850
Case Good, Planter 42in Height, 30W Double 	FA	6P	2H42	30W x 15D x 42H	3,091	4,410	4,118
Case Good, Planter 29H, 45W Triple 	FA	6P	3H29	45W x 15D x 29H	4,282	4,321	4,282
Case Good, Planter 29H, 60W Quad 	FA	6P	4H29	60W x 15D x 29H	5,236	5,284	5,236

To Order Select Below

1. Series/Model

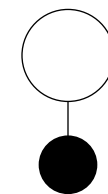

FA6P

**Free Address
Case Good, Planter**

2. Size

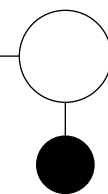

Single

1H29 15 X 29

1H36 15 X 36

1H42 15 X 42

Double

2H29 30 X 29

2H36 30 X 36

2H42 30 X 42

Triple/Quad

3H29 45 X 29

4H29 60 X 29

3. Top Finish

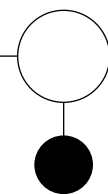

Laminate Grade 1

LM01 DESIGNER WHITE

LM02 ALABASTER

LM03 WALLABY

LM04 SHADOW

LM05 DOVE GRAY

LM06 FASHION GRAY

LM07 SLATE GRAY

LM08 NORTH SEA

LM09 BLACK

LM10 FUSION MAPLE

LM11 MONTICELLO MAPLE

LM12 RIVER CHERRY

LM13 AMBER CHERRY

LM14 WALNUT HEIGHTS

LM15 MONTANA WALNUT

LM16 XANADU

LM17 ASIAN NIGHT

LM18 CASTLE OAK

Laminate wood pattern always runs in the length dimension.

Laminate Grade 2

LM41 BIANCO KOS

LM42 GRIGIO EFESO

LM43 GRIGIO LONDRA

LM44 GRIGIO BROMO

LM45 NERO INGO

Custom Top Finish

LM99 CUSTOM LAMINATE

WV99 CUSTOM WOOD VENEER

Refer to [page 10](#) for custom top details.

Veneer

WV01 LIGHT GRAY

WV02 WARM GRAY

WV03 OPAQUE BLACK

WV04 MEDIUM CHERRY

WV05 TONED ASH

WV06 NATURAL MAPLE

WV41 TONED RECON WALNUT

WV42 DARK TONED OAK

WV43 TONED WENGE

WV44 TONED OAK

WV45 TONED RECON OAK

WV46 NATURAL FLAT CUT WALNUT

WV47 NATURAL RIFT CUT WALNUT

WV48 NATURAL WHITE OAK



WV49 NATURAL RECON WHITE OAK

Wood veneer grain direction always runs in the length dimension.

Free Address

CASE GOODS: SHELVING

*Height when mounted on a frame.

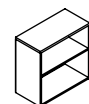
TITLE	SERIES	MODEL	SIZE	DIMENSIONS	LM1	LM2	WV1
Case Good, Shelving 29H 	FA	6S	H29	30W x 15D x 29H	2,032	3,397	3,215
Case Good, Shelving 36H 	FA	6S	H36	30W x 15D x 36H	2,475	3,916	3,703
Case Good, Shelving 42H 	FA	6S	H42	30W x 15D x 42H	2,693	4,159	3,938

To Order Select Below

1. Series/Model

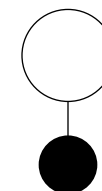

FA6S

**Free Address
Case Good, Shelving**

2. Height

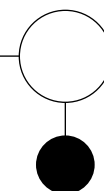

Height

H29 29 HIGH

H36 36 HIGH

H42 42 HIGH

3. Top Finish

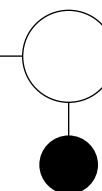

Laminate Grade 1

LM01 DESIGNER WHITE

LM02 ALABASTER

LM03 WALLABY

LM04 SHADOW

LM05 DOVE GRAY

LM06 FASHION GRAY

LM07 SLATE GRAY

LM08 NORTH SEA

LM09 BLACK

LM10 FUSION MAPLE

LM11 MONTICELLO MAPLE

LM12 RIVER CHERRY

LM13 AMBER CHERRY

LM14 WALNUT HEIGHTS

LM15 MONTANA WALNUT

LM16 XANADU

LM17 ASIAN NIGHT

LM18 CASTLE OAK

Laminate wood pattern always runs in the length dimension.

Laminate Grade 2



LM41 BIANCO KOS

LM42 GRIGIO EFESO

LM43 GRIGIO LONDRA

LM44 GRIGIO BROMO

LM45 NERO INGO

Custom Top Finish



LM99 CUSTOM LAMINATE

WV99 CUSTOM WOOD VENEER

Refer to [page 10](#) for custom top details.

Veneer



WV01 LIGHT GRAY

WV02 WARM GRAY

WV03 OPAQUE BLACK

WV04 MEDIUM CHERRY

WV05 TONED ASH

WV06 NATURAL MAPLE

WV41 TONED RECON WALNUT

WV42 DARK TONED OAK

WV43 TONED WENGE

WV44 TONED OAK

WV45 TONED RECON OAK

WV46 NATURAL FLAT CUT WALNUT

WV47 NATURAL RIFT CUT WALNUT

WV48 NATURAL WHITE OAK

WV49 NATURAL RECON WHITE OAK

Wood veneer grain direction always runs in the length dimension.

4. Grain Direction

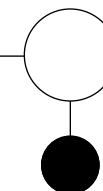

Grain Direction

FB FRONT/BACK



Left/Right is standard and is automatically applied if Front/Back is not specified.

Effective 5/15/2023, lockers, cubbies and shelves in Grade 1 laminate utilize butt-joint construction. Refer to page 21 for details. If the backs of any lockers, cubbies, and shelves will be exposed, we recommend utilizing mitered construction by specifying Grade 2 laminate, wood veneer, or a custom solution.

Free Address

FRAMES: SEAT HEIGHT, 15D

*Glide height adjustability of seat height frames is 5/8"

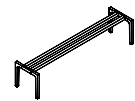
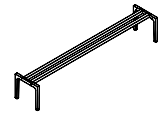
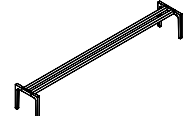
TITLE		SERIES	MODEL	SIZE	DIMENSIONS	PRICE
Frame, Seat Height 15D x 15W		FA	8S	D15L15	15W x 15D x 13H	722
Frame, Seat Height 15D x 30W		FA	8S	D15L30	30W x 15D x 13H	766
Frame, Seat Height 15D x 45W		FA	8S	D15L45	45W x 15D x 13H	881
Frame, Seat Height 15D x 60W		FA	8S	D15L60	60W x 15D x 13H	1,039
Frame, Seat Height 15D x 75W		FA	8S	D15L75	75W x 15D x 13H	1,121
Frame, Seat Height 15D x 90W		FA	8S	D15L90	90W x 15D x 13H	1,163

To Order Select Below

1. Series/Model

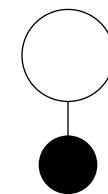

FA8S

**Free Address
Frame, Seat Height**

2. Size

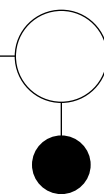

15" Depth

D15L15 15 X 15
 D15L30 15 X 30
 D15L45 15 X 45
 D15L60 15 X 60
 D15L75 15 X 75
 D15L90 15 X 90

5. Frame Finish

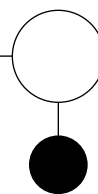

Standard Powder Coated Metal

BL BLUE	MG MEADOW GREEN
BM BLACK MATTE	MK MILK
CP CHAMPAGNE	MS METALLIC SILVER
DB DARK BRONZE	NK NICKEL
DG DARK GRAY	OC OCHRE
DP DUSTY PINK	PY PALE YELLOW
DS DARK SAGE	RO RED ORANGE
LG LIGHT GRAY	RR RUSTY RED
LL LILAC GRAY	SB SOFT BLUE
LP LIGHT PISTACHIO	SD SAND
LR LIPSTICK RED	TC TERRACOTTA
MB MIDNIGHT BLUE	TP TAUPE

Free Address

FRAMES: SEAT HEIGHT, 30D

*Glide height adjustability of seat height frames is 5/8"

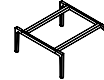
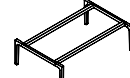
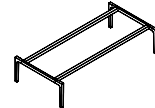
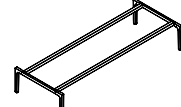
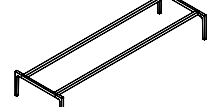
TITLE		SERIES	MODEL	SIZE	DIMENSIONS	PRICE
Frame, Seat Height 30D x 15W		FA	8S	D30L15	15W x 30D x 13H	773
Frame, Seat Height 30D x 30W		FA	8S	D30L30	30W x 30D x 13H	968
Frame, Seat Height 30D x 45W		FA	8S	D30L45	45W x 30D x 13H	1,051
Frame, Seat Height 30D x 60W		FA	8S	D30L60	60W x 30D x 13H	1,250
Frame, Seat Height 30D x 75W		FA	8S	D30L75	75W x 30D x 13H	1,355
Frame, Seat Height 30D x 90W		FA	8S	D30L90	90W x 30D x 13H	1,412

To Order Select Below

1. Series/Model

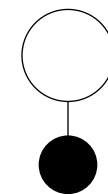

FA8S

**Free Address
Frame, Seat Height**

2. Size

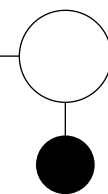

30" Depth

D30L15	30 X 15
D30L30	30 X 30
D30L45	30 X 45
D30L60	30 X 60
D30L75	30 X 75
D30L90	30 X 90

5. Frame Finish

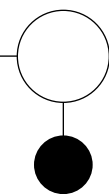

Standard Powder Coated Metal

BL	BLUE	MG	MEADOW GREEN
BM	BLACK MATTE	MK	MILK
CP	CHAMPAGNE	MS	METALLIC SILVER
DB	DARK BRONZE	NK	NICKEL
DG	DARK GRAY	OC	OCHRE
DP	DUSTY PINK	PY	PALE YELLOW
DS	DARK SAGE	RO	RED ORANGE
LG	LIGHT GRAY	RR	RUSTY RED
LL	LILAC GRAY	SB	SOFT BLUE
LP	LIGHT PISTACHIO	SD	SAND
LR	LIPSTICK RED	TC	TERRACOTTA
MB	MIDNIGHT BLUE	TP	TAUPE

Free Address

FRAMES: SEAT HEIGHT, 45D

*Glide height adjustability of seat height frames is 5/8"

TITLE		SERIES	MODEL	SIZE	DIMENSIONS	PRICE
Frame, Seat Height 45D x 15W		FA	8S	D45L15	15W x 45D x 13H	1,253
Frame, Seat Height 45D x 30W		FA	8S	D45L30	30W x 45D x 13H	1,424
Frame, Seat Height 45D x 45W		FA	8S	D45L45	45W x 45D x 13H	1,639
Frame, Seat Height 45D x 60W		FA	8S	D45L60	60W x 45D x 13H	1,797
Frame, Seat Height 45D x 75W		FA	8S	D45L75	75W x 45D x 13H	2,003
Frame, Seat Height 45D x 90W		FA	8S	D45L90	90W x 45D x 13H	2,091

To Order Select Below

1. Series/Model

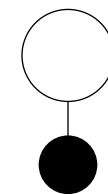

FA8S

**Free Address
Frame, Seat Height**

2. Size

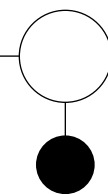

45" Depth

D45L15	45 X 15
D45L30	45 X 30
D45L45	45 X 45
D45L60	45 X 60
D45L75	45 X 75
D45L90	45 X 90

5. Frame Finish

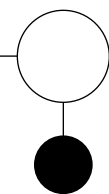

Standard Powder Coated Metal

BL	BLUE	MG	MEADOW GREEN
BM	BLACK MATTE	MK	MILK
CP	CHAMPAGNE	MS	METALLIC SILVER
DB	DARK BRONZE	NK	NICKEL
DG	DARK GRAY	OC	OCHRE
DP	DUSTY PINK	PY	PALE YELLOW
DS	DARK SAGE	RO	RED ORANGE
LG	LIGHT GRAY	RR	RUSTY RED
LL	LILAC GRAY	SB	SOFT BLUE
LP	LIGHT PISTACHIO	SD	SAND
LR	LIPSTICK RED	TC	TERRACOTTA
MB	MIDNIGHT BLUE	TP	TAUPE

Free Address

FRAMES: SEAT WITH LEDGE

*Shorter ledges can be used on taller back panels.

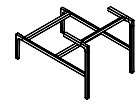
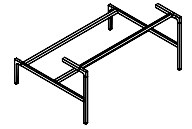
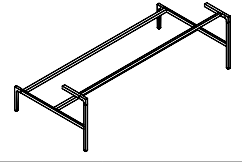
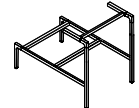
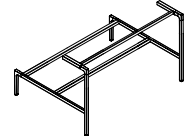
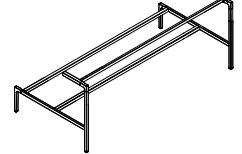
TITLE		SERIES	MODEL	SIZE	DIMENSIONS	PRICE
Frame, Seat with Ledge 29H, 30W		FA	8L	H29L30	30W x 30D x 29H	1,478
Frame, Seat with Ledge 29H, 60W		FA	8L	H29L60	60W x 30D x 29H	1,818
Frame, Seat with Ledge 29H, 90W		FA	8L	H29L90	90W x 30D x 29H	2,045
Frame, Seat with Ledge 36H, 30W		FA	8L	H36L30	30W x 30D x 36H	1,628
Frame, Seat with Ledge 36H, 60W		FA	8L	H36L60	60W x 30D x 36H	1,927
Frame, Seat with Ledge 36H, 90W		FA	8L	H36L90	90W x 30D x 36H	2,118

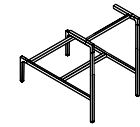
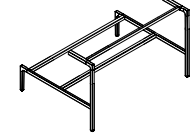
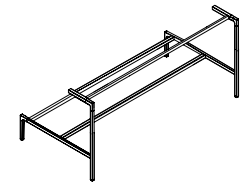
TITLE		SERIES	MODEL	SIZE	DIMENSIONS	PRICE
Frame, Seat with Ledge 42H, 30W		FA	8L	H42L30	30W x 30D x 42H	1,638
Frame, Seat with Ledge 42H, 60W		FA	8L	H42L60	60W x 30D x 42H	1,936
Frame, Seat with Ledge 42H, 90W		FA	8L	H42L90	90W x 30D x 42H	2,130

To Order Select Below

1. Series/Model

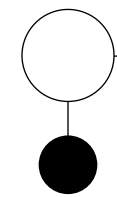

FA8L

**Free Address
Frame, Seat with Ledge**

2. Size

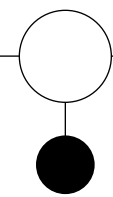

29" High

H29L30 29H X 30W

H29L60 29H X 60W

H29L90 29H X 90W

36" High

H36L30 36H X 30W

H36L60 36H X 60W

H36L90 36H X 90W

3. Frame Finish

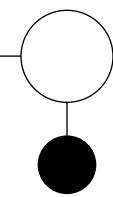

Standard Powder Coated Metal

BL BLUE

BM BLACK MATTE

CP CHAMPAGNE

DB DARK BRONZE

DG DARK GRAY

DP DUSTY PINK

DS DARK SAGE

LG LIGHT GRAY

LL LILAC GRAY

LP LIGHT PISTACHIO

LR LIPSTICK RED

MB MIDNIGHT BLUE

MG MEADOW GREEN

MK MILK

MS METALLIC SILVER

NK NICKEL

OC OCHRE

PY PALE YELLOW

RO RED ORANGE

RR RUSTY RED

SB SOFT BLUE

SD SAND

TC TERRACOTTA

TP TAUPE

Free Address

TABLET ARM: UNDER MOUNT

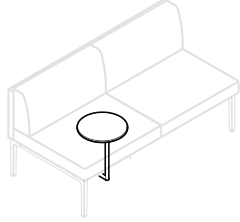
TITLE	SERIES	TYPE	DIMENSIONS	PRICE
Under Mount Tablet Arm, Single Swivel 	FA	TA1	14W x 14D	- 832
Under Mount Tablet Arm, Dual Swivel 	FA	TA2	14W x 14D	- 832

To Order Select Below

1. Series/Model

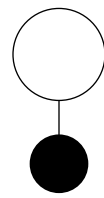

FATA1
Free Address
Tablet, Under Mount, Single Swivel

FATA2
Free Address
Tablet, Under Mount, Dual Swivel

2. Top Finish

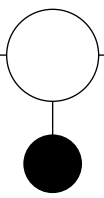

Wood Finish

SW81 WHITE OAK
 SW83 MAPLE
 SW85 WALNUT **+73**
 SW87 OPAQUE BLACK

3. Frame Finish

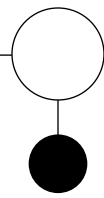



Standard Powder Coated Metal





BL BLUE	MG MEADOW GREEN
BM BLACK MATTE	MK MILK
CP CHAMPAGNE	MS METALLIC SILVER
DB DARK BRONZE	NK NICKEL
DG DARK GRAY	OC OCHRE
DP DUSTY PINK	PY PALE YELLOW
DS DARK SAGE	RO RED ORANGE
LG LIGHT GRAY	RR RUSTY RED
LL LILAC GRAY	SB SOFT BLUE
LP LIGHT PISTACHIO	SD SAND
LR LIPSTICK RED	TC TERRACOTTA
MB MIDNIGHT BLUE	TP TAUPE

Free Address

TABLES: FREESTANDING, 29H

*Glide height adjustability of 29H, 36H, and 42H tables is 1". Casters are not offered on table runs.

TITLE		SERIES	MODEL	SIZE	DIMENSIONS	LM1	LM2	WV1	
Table, Free Standing 29in Desk Height, 15D x 30W		FA	5D	1530	30W x 15D x 29H	1,540	1,444	1,568	
Table, Free Standing 29in Desk Height, 15D x 45W		FA	5D	1545	45W x 15D x 29H	1,769	1,701	1,914	
Table, Free Standing 29in Desk Height, 15D x 60W		FA	5D	1560	60W x 15D x 29H	1,890	1,935	2,201	

TITLE		SERIES	MODEL	SIZE	DIMENSIONS	LM1	LM2	WV1	
Table, Free Standing 29in Desk Height, 30D x 15W		FA	5D	3015	15W x 30D x 29H	1,575	1,470	1,592	
Table, Free Standing 29in Desk Height, 30D x 30W		FA	5D	3030	30W x 30D x 29H	1,851	1,815	2,104	
Table, Free Standing 29in Desk Height, 30D x 45W		FA	5D	3045	45W x 30D x 29H	2,196	2,207	2,658	
Table, Free Standing 29in Desk Height, 30D x 60W		FA	5D	3060	60W x 30D x 29H	2,394	2,579	3,149	

To Order Select Below

1. Series/Model

FA5D
Free Address Tables, Freestanding 29H Desk Height

2. Table Runs

Table Runs
RS TABLE RUN, START
RM TABLE RUN, MID
RE TABLE RUN, END
Runs are for all tables except 15" length tops.

3. Size

15" Deep
1530 45D X 30W
1545 45D X 45W
1560 45D X 60W
30" Deep
3015 30D X 15W
3030 30D X 30W
3045 30D X 45W
3060 30D X 60W

4. Top Finish

Laminate Grade 1
LM01 DESIGNER WHITE
LM02 ALABASTER
LM03 WALLABY
LM04 SHADOW
LM05 DOVE GRAY
LM06 FASHION GRAY
LM07 SLATE GRAY
LM08 NORTH SEA
LM09 BLACK
LM10 FUSION MAPLE
LM11 MONTICELLO MAPLE
LM12 RIVER CHERRY
LM13 AMBER CHERRY
LM14 WALNUT HEIGHTS
LM15 MONTANA WALNUT
LM16 XANADU
LM17 ASIAN NIGHT
LM18 CASTLE OAK

Laminate wood pattern always runs in the length dimension.

Laminate Grade 2

LM41 BIANCO KOS
LM42 GRIGIO EFESO
LM43 GRIGIO LONDRA
LM44 GRIGIO BROMO
LM45 NERO INGO

Custom Top Finish

LM99 CUSTOM LAMINATE
WV99 CUSTOM WOOD VENEER

Refer to [page 10](#) for custom top details.

5. Frame Finish

Standard Powder Coated Metal
BL BLUE
BM BLACK MATTE
CP CHAMPAGNE
DB DARK BRONZE
DG DARK GRAY
DP DUSTY PINK
DS DARK SAGE
LG LIGHT GRAY
LL LILAC GRAY
LP LIGHT PISTACHIO
LR LIPSTICK RED
MB MIDNIGHT BLUE
MG MEADOW GREEN
MK MILK
MS METALLIC SILVER
NK NICKEL
OC OCHRE
PY PALE YELLOW
RO RED ORANGE
RR RUSTY RED
SB SOFT BLUE
SD SAND
TC TERRACOTTA
TP TAUPE

Veneer

WV01 LIGHT GRAY
WV02 WARM GRAY
WV03 OPAQUE BLACK
WV04 MEDIUM CHERRY
WV05 TONED ASH
WV06 NATURAL MAPLE
WV41 TONED RECON WALNUT
WV42 DARK TONED OAK
WV43 TONED WENGE
WV44 TONED OAK
WV45 TONED RECON OAK
WV46 NATURAL FLAT CUT WALNUT
WV47 NATURAL RIFT CUT WALNUT
WV48 NATURAL WHITE OAK
WV49 NATURAL RECON WHITE OAK

Wood veneer grain direction always runs in the length dimension.

6. Options

Screens
For screen options see pages 60-65 .
Power
Refer to under mount power ordering steps on page 12 and the surface mount powder ordering steps on page 13 .
Casters
C1 HARD BLACK CASTERS +49
CS1 SOFT BLACK CASTERS +66

Free Address

TABLES: FREESTANDING, 29H

*Glide height adjustability of 29H, 36H, and 42H tables is 1". Casters are not offered on table runs.

TITLE		SERIES	MODEL	SIZE	DIMENSIONS	LM1	LM2	WV1	
Table, Free Standing 29in Desk Height, 45D x 15W		FA	5D	4515	15W x 45D x 29H	1,732	1,665	1,871	
Table, Free Standing 29in Desk Height, 45D x 30W		FA	5D	4530	30W x 45D x 29H	2,158	2,172	2,625	
Table, Free Standing 29in Desk Height, 45D x 45W		FA	5D	4545	45W x 45D x 29H	2,503	2,688	3,400	
Table, Free Standing 29in Desk Height, 45D x 60W		FA	5D	4560	60W x 45D x 29H	2,736	3,141	4,130	

TITLE		SERIES	MODEL	SIZE	DIMENSIONS	LM1	LM2	WV1	
Table, Free Standing 29in Desk Height, 60D x 15W		FA	5D	6015	15W x 60D x 29H	1,883	1,922	2,181	
Table, Free Standing 29in Desk Height, 60D x 30W		FA	5D	6030	30W x 60D x 29H	2,355	2,546	3,115	
Table, Free Standing 29in Desk Height, 60D x 45W		FA	5D	6045	45W x 60D x 29H	2,736	3,141	4,130	
Table, Free Standing 29in Desk Height, 60D x 60W		FA	5D	6060	60W x 60D x 29H	2,868	4,848	4,890	

To Order Select Below

1. Series/Model

- FA5D
**Free Address
Tables, Freestanding
29H Desk Height**

2. Table Runs

- RS TABLE RUN, START
- RM TABLE RUN, MID
- RE TABLE RUN, END

Runs are for all tables except 15" length tops.

3. Size

- 45" Deep**
 - 4515 45D X 15W
 - 4530 45D X 30W
 - 4545 45D X 45W
 - 4560 45D X 60W
- 60" Deep**
 - 6015 60D X 15W
 - 6030 60D X 30W
 - 6045 60D X 45W
 - 6060 60D X 60W

4. Top Finish

- Laminate Grade 1**
 - LM01 DESIGNER WHITE
 - LM02 ALABASTER
 - LM03 WALLABY
 - LM04 SHADOW
 - LM05 DOVE GRAY
 - LM06 FASHION GRAY
 - LM07 SLATE GRAY
 - LM08 NORTH SEA
 - LM09 BLACK
 - LM10 FUSION MAPLE
 - LM11 MONTICELLO MAPLE
 - LM12 RIVER CHERRY
 - LM13 AMBER CHERRY
 - LM14 WALNUT HEIGHTS
 - LM15 MONTANA WALNUT
 - LM16 XANADU
 - LM17 ASIAN NIGHT
 - LM18 CASTLE OAK
- Laminate Grade 2**
 - LM41 BIANCO KOS
 - LM42 GRIGIO EFESO
 - LM43 GRIGIO LONDRA
 - LM44 GRIGIO BROMO
 - LM45 NERO INGO
- Custom Top Finish**
 - LM99 CUSTOM LAMINATE
 - WV99 CUSTOM WOOD VENEER

Refer to [page 10](#) for custom top details.

Laminate wood pattern always runs in the length dimension.

5. Frame Finish

- Veneer**
 - WV01 LIGHT GRAY
 - WV02 WARM GRAY
 - WV03 OPAQUE BLACK
 - WV04 MEDIUM CHERRY
 - WV05 TONED ASH
 - WV06 NATURAL MAPLE
 - WV41 TONED RECON WALNUT
 - WV42 DARK TONED OAK
 - WV43 TONED WENGE
 - WV44 TONED OAK
 - WV45 TONED RECON OAK
 - WV46 NATURAL FLAT CUT WALNUT
 - WV47 NATURAL RIFT CUT WALNUT
 - WV48 NATURAL WHITE OAK
 - WV49 NATURAL RECON WHITE OAK

Wood veneer grain direction always runs in the length dimension.
- Standard Powder Coated Metal**
 - BL BLUE
 - BM BLACK MATTE
 - CP CHAMPAGNE
 - DB DARK BRONZE
 - DG DARK GRAY
 - DP DUSTY PINK
 - DS DARK SAGE
 - LG LIGHT GRAY
 - LL LILAC GRAY
 - LP LIGHT PISTACHIO
 - LR LIPSTICK RED
 - MB MIDNIGHT BLUE
 - MG MEADOW GREEN
 - MK MILK
 - MS METALLIC SILVER
 - NK NICKEL
 - OC OCHRE
 - PY PALE YELLOW
 - RO RED ORANGE
 - RR RUSTY RED
 - SB SOFT BLUE
 - SD SAND
 - TC TERRACOTTA
 - TP TAUPE

6. Options

- Screens**
For screen options see [pages 59-64](#).
- Power**
Refer to under mount power ordering steps on [page 12](#) and the surface mount powder ordering steps on [page 13](#).
- Casters**
 - C1 HARD BLACK CASTERS **+49**
 - CS1 SOFT BLACK CASTERS **+66**

Free Address

TABLES: FREESTANDING, 36H AND 42H

*Glide height adjustability of 29H, 36H, and 42H tables is 1". Casters are not offered on table runs.

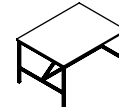
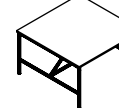
TITLE		SERIES	MODEL	SIZE	DIMENSIONS	LM1	LM2	WV1	
Table, Free Standing 36in Counter Height, 30D x 60W		FA	5C	3060	60W x 30D x 36H	2,776	2,912	3,480	
Table, Free Standing 36in Counter Height, 45D x 60W		FA	5C	4560	60W x 45D x 36H	3,141	3,492	4,481	
Table, Free Standing 36in Counter Height, 60D x 60W		FA	5C	6060	60W x 60D x 36H	3,301	5,638	5,266	

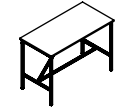
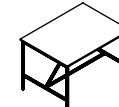
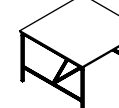
TITLE		SERIES	MODEL	SIZE	DIMENSIONS	LM1	LM2	WV1	
Table, Free Standing 42in Bar Height, 30D x 60W		FA	5B	3060	60W x 30D x 42H	2,855	2,980	3,551	
Table, Free Standing 42in Bar Height, 45D x 60W		FA	5B	4560	60W x 45D x 42H	3,197	3,540	4,530	
Table, Free Standing 42in Bar Height, 60D x 60W		FA	5B	6060	60W x 60D x 42H	3,357	5,672	5,313	

To Order Select Below

1. Series/Model

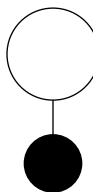

FA5C
**Free Address
Tables, Freestanding
36H Counter Height**

FA5B

**Free Address
Tables, Freestanding
42H Bar Height**

2. Table Runs

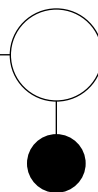
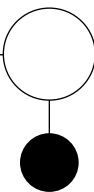

Table Runs

RS TABLE RUN, START
RM TABLE RUN, MID
RE TABLE RUN, END

Runs are for all tables except
15" length tops.

3. Size



60" Length

3060 30D X 60L
4560 45D X 60L
6060 60D X 60L

4. Top Finish

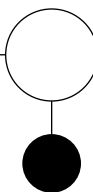

Laminate Grade 1

LM01 DESIGNER WHITE
LM02 ALABASTER
LM03 WALLABY
LM04 SHADOW
LM05 DOVE GRAY
LM06 FASHION GRAY
LM07 SLATE GRAY
LM08 NORTH SEA
LM09 BLACK
LM10 FUSION MAPLE
LM11 MONTICELLO MAPLE
LM12 RIVER CHERRY
LM13 AMBER CHERRY
LM14 WALNUT HEIGHTS
LM15 MONTANA WALNUT
LM16 XANADU
LM17 ASIAN NIGHT
LM18 CASTLE OAK

Laminate wood pattern always
runs in the length dimension.

Laminate Grade 2

LM41 BIANCO KOS
LM42 GRIGIO EFESO
LM43 GRIGIO LONDRA
LM44 GRIGIO BROMO
LM45 NERO INGO

Custom Top Finish

LM99 CUSTOM LAMINATE
WV99 CUSTOM WOOD VENEER

Refer to [page 10](#) for custom top details.

5. Frame Finish

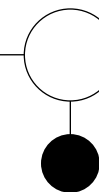

Standard Powder Coated Metal

BL BLUE
BM BLACK MATTE
CP CHAMPAGNE
DB DARK BRONZE
DG DARK GRAY
DP DUSTY PINK
DS DARK SAGE
LG LIGHT GRAY
LL LILAC GRAY
LP LIGHT PISTACHIO
LR LIPSTICK RED
MB MIDNIGHT BLUE

MG MEADOW GREEN
MK MILK
MS METALLIC SILVER
NK NICKEL
OC OCHRE
PY PALE YELLOW
RO RED ORANGE
RR RUSTY RED
SB SOFT BLUE
SD SAND
TC TERRACOTTA
TP TAUPE

Veneer

WV01 LIGHT GRAY
WV02 WARM GRAY
WV03 OPAQUE BLACK
WV04 MEDIUM CHERRY
WV05 TONED ASH
WV06 NATURAL MAPLE
WV41 TONED RECON WALNUT
WV42 DARK TONED OAK
WV43 TONED WENGE
WV44 TONED OAK
WV45 TONED RECON OAK
WV46 NATURAL FLAT CUT WALNUT
WV47 NATURAL RIFT CUT WALNUT
WV48 NATURAL WHITE OAK
WV49 NATURAL RECON WHITE OAK

Wood veneer grain direction always
runs in the length dimension.

6. Options

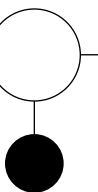

Screens

For screen options
see [pages 59-64](#).

Power

Refer to under mount
power ordering
steps on [page 12](#) and
the surface mount
powder ordering
steps on [page 13](#).

Casters

C1 HARD BLACK
CASTERS **+49**
CS1 SOFT BLACK
CASTERS **+66**

Free Address

PRIVACY SCREENS: CENTER, 45L

*Height is from table top surface. Center screens are only available on 45", or 60" deep tables.

Textile Upholstery Grades

TITLE	SERIES	MODEL	HEIGHT	DIMENSIONS	YDG	COM	A	B	C	D	E	F	G	H	I	J	K	L	M
Privacy Screen, Center 45 Partial, Low	FA	7P	C41	27W x 1D x 10H	1.1	385	470	516	561	606	652	702	752	812	888	980	1,071	1,163	1,254
Privacy Screen, Center 45 Partial, Mid	FA	7P	C42	27W x 1D x 15H	1.1	427	512	558	603	649	695	744	795	855	931	1,022	1,114	1,205	1,297
Privacy Screen, Center 45 Full, Low	FA	7P	C46	43W x 1D x 10H	1.7	470	595	665	733	801	870	945	1,021	1,111	1,224	1,361	1,500	1,637	1,773
Privacy Screen, Center 45 Full, Mid	FA	7P	C47	43W x 1D x 15H	1.7	512	638	706	773	843	913	987	1,063	1,152	1,267	1,404	1,542	1,680	1,815

To Order Select Below

1. Series/Model

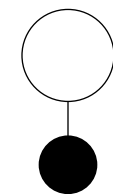

FA7PC4

**Free Address
Privacy Screen, Center, 45"**

2. Height

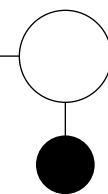

Partial

- 1 LOW
- 2 MID

Full

- 6 LOW
- 7 MID

3. Upholstery

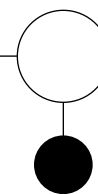

Upholstery

See general information section for details on textile program and COM/ COL information.

Yardages provided are for fabrics cut railroaded. While that is generally our preference for Free Address, there may be exceptions if we decide that up the roll is more visually pleasing. If COM fabrics are to be cut up the roll, please contact customer service.

Screens are tack-able surfaces. Please keep this in mind when specifying upholstery grade fabrics. Leathers and vinyls are not approved for use on screens.

Free Address

PRIVACY SCREENS: CENTER, 60L

*Height is from table top surface. Center screens are only available on 45", or 60" deep tables.

Textile Upholstery Grades

TITLE	SERIES	MODEL	HEIGHT	DIMENSIONS	YDG	COM	A	B	C	D	E	F	G	H	I	J	K	L	M
Privacy Screen, Center 60 Partial, Low	FA	7P	C61	42W x 1D x 10H	1.7	470	595	665	733	801	870	945	1,021	1,111	1,224	1,362	1,500	1,637	1,773
Privacy Screen, Center 60 Partial, Mid	FA	7P	C62	42W x 1D x 15H	1.7	511	636	705	772	842	911	986	1,062	1,151	1,266	1,403	1,538	1,679	1,814
Privacy Screen, Center 60 Full, Low	FA	7P	C66	58W x 1D x 10H	2.2	579	748	839	930	1,021	1,114	1,215	1,315	1,434	1,587	1,770	1,951	2,137	2,318
Privacy Screen, Center 60 Full, Mid	FA	7P	C67	58W x 1D x 15H	2.2	626	795	887	977	1,068	1,161	1,262	1,360	1,481	1,633	1,817	2,000	2,183	2,364

To Order Select Below

1. Series/Model

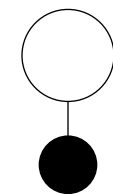

FA7PC6

**Free Address
Privacy Screen, Center, 60"**

2. Height

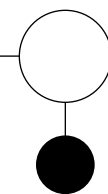

Partial

- 1 LOW
- 2 MID

Full

- 6 LOW
- 7 MID

3. Upholstery

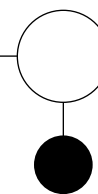

Upholstery

See general information section for details on textile program and COM/ COL information.

Yardages provided are for fabrics cut railroaded. While that is generally our preference for Free Address, there may be exceptions if we decide that up the roll is more visually pleasing. If COM fabrics are to be cut up the roll, please contact customer service.

Screens are tack-able surfaces. Please keep this in mind when specifying upholstery grade fabrics. Leathers and vinyls are not approved for use on screens.

Free Address

PRIVACY SCREENS: PERIMETER, 30W

*Height is from table top surface. 30" perimeter screens available on 30", 45", 60" long tables.
0.5" gap from screen to edge of table for cables/accessories.

Textile Upholstery Grades

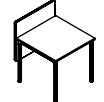
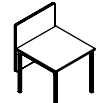
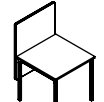
TITLE	SERIES	MODEL	HEIGHT	DIMENSIONS	YDG	COM	A	B	C	D	E	F	G	H	I	J	K	L	M
Privacy Screen, Perimeter 30W, Low 	FA	7P	P36	30W x 1D x 10H	2.2	604	772	865	955	1,046	1,138	1,239	1,340	1,459	1,611	1,795	1,977	2,161	2,343
Privacy Screen, Perimeter 30W, Mid 	FA	7P	P37	30W x 1D x 15H	2.2	638	807	899	988	1,080	1,173	1,272	1,374	1,492	1,645	1,829	2,010	2,195	2,377
Privacy Screen, Perimeter 30W, High 	FA	7P	P38	30W x 1D x 21H	2.2	683	853	944	1,034	1,126	1,219	1,320	1,420	1,538	1,691	1,875	2,057	2,242	2,423

To Order Select Below

1. Series/Model

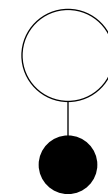

FA7PP3

**Free Address
Privacy Screen, Perimeter, 30"**

2. Height

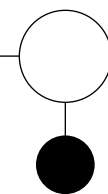

Height

6 LOW

7 MID

8 HIGH

3. Upholstery

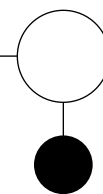

Upholstery

See general information section for details on textile program and COM/ COL information.

Yardages provided are for fabrics cut railroaded. While that is generally our preference for Free Address, there may be exceptions if we decide that up the roll is more visually pleasing. If COM fabrics are to be cut up the roll, please contact customer service.

Screens are tack-able surfaces. Please keep this in mind when specifying upholstery grade fabrics. Leathers and vinyls are not approved for use on screens.

Free Address

PRIVACY SCREENS: PERIMETER, 45W

*Height is from table top surface. All 45" long perimeter screens are available on 45", or 60" long tables.

Textile Upholstery Grades

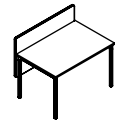
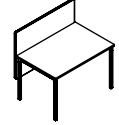
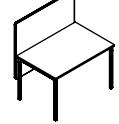
TITLE	SERIES	MODEL	HEIGHT	DIMENSIONS	YDG	COM	A	B	C	D	E	F	G	H	I	J	K	L	M
Privacy Screen, Perimeter 45W, Low 	FA	7P	P46	45W x 1D x 10H	3.3	705	957	1,095	1,229	1,369	1,506	1,657	1,808	1,986	2,213	2,491	2,763	3,040	3,313
Privacy Screen, Perimeter 45W, Mid 	FA	7P	P47	45W x 1D x 15H	3.3	746	998	1,136	1,270	1,409	1,546	1,697	1,848	2,026	2,255	2,531	2,803	3,080	3,353
Privacy Screen, Perimeter 45W, High 	FA	7P	P48	45W x 1D x 21H	3.3	795	1,047	1,185	1,320	1,459	1,596	1,746	1,898	2,077	2,305	2,581	2,855	3,129	3,404

To Order Select Below

1. Series/Model

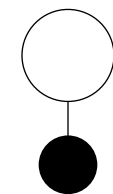

FA7PP4

**Free Address
Privacy Screen, Perimeter, 45"**

2. Height

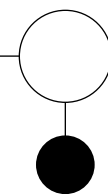

Height

6 LOW

7 MID

8 HIGH

3. Upholstery

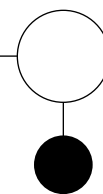

Upholstery

See general information section for details on textile program and COM/ COL information.

Yardages provided are for fabrics cut railroaded. While that is generally our preference for Free Address, there may be exceptions if we decide that up the roll is more visually pleasing. If COM fabrics are to be cut up the roll, please contact customer service.

Screens are tack-able surfaces. Please keep this in mind when specifying upholstery grade fabrics. Leathers and vinyls are not approved for use on screens.

Free Address

PRIVACY SCREENS: PERIMETER, 60W

*Height is from table top surface. All 60" long perimeter screens are available on 60" long tables only.

Textile Upholstery Grades

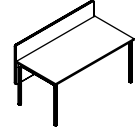
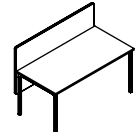
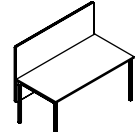
TITLE	SERIES	MODEL	HEIGHT	DIMENSIONS	YDG	COM	A	B	C	D	E	F	G	H	I	J	K	L	M
Privacy Screen, Perimeter 60W, Low 	FA	7P	P66	60W x 1D x 10H	4.4	961	1,297	1,481	1,661	1,846	2,030	2,230	2,430	2,670	2,973	3,343	3,706	4,075	4,438
Privacy Screen, Perimeter 60W, Mid 	FA	7P	P67	60W x 1D x 15H	4.4	1,051	1,389	1,574	1,752	1,936	2,122	2,322	2,523	2,760	3,065	3,434	3,798	4,167	4,529
Privacy Screen, Perimeter 60W, High 	FA	7P	P68	60W x 1D x 21H	4.4	1,122	1,459	1,642	1,822	2,006	2,191	2,392	2,593	2,832	3,136	3,504	3,867	4,236	4,600

To Order Select Below

1. Series/Model

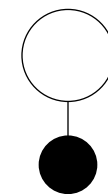

FA7PP6

**Free Address
Privacy Screen, Perimeter, 60"**

2. Height

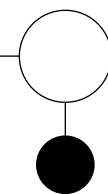

Height

6 LOW

7 MID

8 HIGH

3. Upholstery

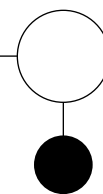

Upholstery

See general information section for details on textile program and COM/ COL information.

Yardages provided are for fabrics cut railroaded. While that is generally our preference for Free Address, there may be exceptions if we decide that up the roll is more visually pleasing. If COM fabrics are to be cut up the roll, please contact customer service.

Screens are tack-able surfaces. Please keep this in mind when specifying upholstery grade fabrics. Leathers and vinyls are not approved for use on screens.

Free Address

PRIVACY SCREENS: SIDE

*PS23 and PS24 are only available on 45" and 60" deep tables.

Textile Upholstery Grades

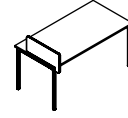
TITLE	SERIES	MODEL	HEIGHT	DIMENSIONS	YDG	COM	A	B	C	D	E	F	G	H	I	J	K	L	M
Privacy Screen, Side Quantity 1 	FA	7P	S21	25W x 1D x 10H	1.1	365	448	495	540	586	631	681	732	791	867	960	1,050	1,143	1,234

To Order Select Below

1. Series/Model

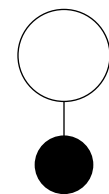

FA7PS2

Free Address
Privacy Screen, Side

2. Quantity

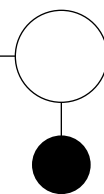

Quantity

- 1 QUANTITY 1
- 2 QUANTITY 2
- 3 QUANTITY 3
- 4 QUANTITY 4

3. Upholstery

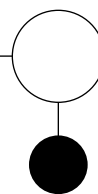

Upholstery

See general information section for details on textile program and COM/ COL information.

Yardages provided are for fabrics cut railroaded. While that is generally our preference for Free Address, there may be exceptions if we decide that up the roll is more visually pleasing. If COM fabrics are to be cut up the roll, please contact customer service.

Screens are tack-able surfaces. Please keep this in mind when specifying upholstery grade fabrics. Leathers and vinyls are not approved for use on screens.

Free Address

MODESTY SCREENS

*The bottom of modesty screens measure 13" from the floor.

Textile Upholstery Grades

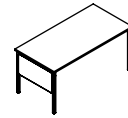
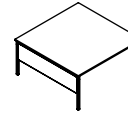
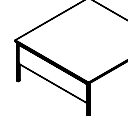
TITLE	SERIES	MODEL	HEIGHT	DIMENSIONS	YDG	COM	A	B	C	D	E	F	G	H	I	J	K	L	M
Privacy Screen, Modesty 30W End, Quantity 1 	FA	7M	E31	30W x 1D x 13H	1.1	442	526	572	617	662	708	760	809	869	944	1,038	1,129	1,221	1,311
Privacy Screen, Modesty 45W End, Quantity 1 	FA	7M	E41	45W x 1D x 13H	1.7	505	632	702	769	837	908	983	1,058	1,148	1,262	1,400	1,535	1,674	1,811
Privacy Screen, Modesty 60W End, Quantity 1 	FA	7M	E61	60W x 1D x 13H	2.2	608	777	868	958	1,050	1,143	1,243	1,344	1,462	1,615	1,798	1,980	2,165	2,346

To Order Select Below

1. Series/Model

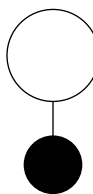

FA7ME3

**Free Address
Modesty, End for 30W**

FA7ME4

**Free Address
Modesty, End for 45W**

FA7ME6

**Free Address
Modesty, End for 60W**

2. Quantity

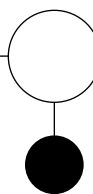

Quantity

1 QUANTITY 1

2 QUANTITY 2

3. Upholstery

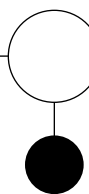

Upholstery

See general information section for details on textile program and COM/ COL information.

Yardages provided are for fabrics cut railroaded. While that is generally our preference for Free Address, there may be exceptions if we decide that up the roll is more visually pleasing. If COM fabrics are to be cut up the roll, please contact customer service.

Screens are tack-able surfaces. Please keep this in mind when specifying upholstery grade fabrics. Leathers and vinyls are not approved for use on screens.